



# COMPOSITIO MATHEMATICA

## Annular Khovanov homology and knotted Schur–Weyl representations

J. Elisenda Grigsby, Anthony M. Licata and Stephan M. Wehrli

Compositio Math. **154** (2018), 459–502.

[doi:10.1112/S0010437X17007540](https://doi.org/10.1112/S0010437X17007540)



FOUNDATION  
COMPOSITIO  
MATHEMATICA



LONDON  
MATHEMATICAL  
SOCIETY  
EST. 1865



# Annular Khovanov homology and knotted Schur–Weyl representations

J. Elisenda Grigsby, Anthony M. Licata and Stephan M. Wehrli

## ABSTRACT

Let  $\mathbb{L} \subset A \times I$  be a link in a thickened annulus. We show that its sutured annular Khovanov homology carries an action of  $\mathfrak{sl}_2(\wedge)$ , the exterior current algebra of  $\mathfrak{sl}_2$ . When  $\mathbb{L}$  is an  $m$ -framed  $n$ -cable of a knot  $K \subset S^3$ , its sutured annular Khovanov homology carries a commuting action of the symmetric group  $\mathfrak{S}_n$ . One therefore obtains a ‘knotted’ Schur–Weyl representation that agrees with classical  $\mathfrak{sl}_2$  Schur–Weyl duality when  $K$  is the Seifert-framed unknot.

## 1. Introduction

Knot homologies, like the quantum knot polynomials they categorify, are intimately connected to the representation theory of Lie algebras and quantum groups. Khovanov homology, the first of these homology theories, can be constructed by categorifying a part of the representation theory of  $U_q(\mathfrak{sl}_2)$ . Roughly speaking, the idea is to lift the Reshetikhin–Turaev graphical calculus of  $U_q(\mathfrak{sl}_2)$ -intertwiners one level on the categorical ladder.

### 1.1 Tangle invariants and link homologies from $U_q(\mathfrak{sl}_2)$ categorification

Let  $T$  be a tangle in  $D^2 \times I$  connecting  $n$  points in  $D^2 \times \{0\}$  to  $m$  points in  $D^2 \times \{1\}$ . The most basic of the Reshetikhin–Turaev tangle invariants assigns to  $T$  a  $U_q(\mathfrak{sl}_2)$  homomorphism

$$\psi(T) : V_{(1)}^{\otimes n} \longrightarrow V_{(1)}^{\otimes m},$$

where  $V_{(1)}$  is the defining two-dimensional representation of the quantum group  $U_q(\mathfrak{sl}_2)$ .

To categorify the Reshetikhin–Turaev tangle invariant, one replaces the  $\mathbb{C}(q)$  vector spaces  $V_{(1)}^{\otimes n}$  by a graded category  $\mathcal{C}(n)$  with Grothendieck group  $K_0(\mathcal{C}(n)) \cong V_{(1)}^{\otimes n}$ ; the linear map  $\psi(T)$  is then upgraded to a functor

$$\Psi(T) : \mathcal{C}(n) \longrightarrow \mathcal{C}(m),$$

with  $K_0(\Psi(T)) = \psi(T)$ . A fascinating aspect of the story is that the category  $\mathcal{C}(n)$  can be chosen from a number of mathematical subjects. The category  $\mathcal{C}(n)$  could be a category of coherent or constructible sheaves on an algebraic variety, a Fukaya category of a symplectic manifold, a category of modular representations of a finite group, a category of matrix factorizations, or a category of modules over a finite-dimensional algebra [SS06, CK08, KR08, Str05, Web16, Sus07, CK14, BS11]. The choice which is most directly relevant for the current paper is due to Chen and

---

Received 4 November 2015, accepted in final form 22 May 2017, published online 28 November 2017.

2010 Mathematics Subject Classification 57M27 (primary), 81R50, 20F36 (secondary).

JEG was partially supported by NSF CAREER award DMS-1151671. AML was partially supported by a Discovery Project grant from the Australian Research Council. SMW was partially supported by NSF grant DMS-1111680.

This journal is © Foundation Compositio Mathematica 2017.

Khovanov [CK14] and independently Brundan and Stroppel [BS11], who define finite-dimensional algebras  $A_n$  and take  $\mathcal{C}(n)$  to be the derived category of left  $A_n$  modules. The functor-valued tangle invariant  $\Psi(T)$  is then given by tensoring with a complex of  $(A_n, A_m)$  bimodules specified by a cube of resolutions of the tangle  $T$ .<sup>1</sup>

Given an  $(n, n)$  tangle  $T$ , it is natural to study its closure,  $\widehat{T}$ , as a link in the thickened annulus  $A \times I$ . To obtain a topological invariant of this closure, one can then take the derived self-tensor product (Hochschild homology) of the  $(A_n, A_n)$  bimodule described above. Alternatively, one can consider its sutured annular Khovanov homology  $\text{SKh}(\widehat{T})$ , defined by Asaeda, Przytycki and Sikora [APS04].<sup>2</sup> Sutured annular Khovanov homology is defined using an explicit chain complex coming from a cube of resolutions, much in the spirit of Khovanov’s original definition of a homology theory for links in  $S^3$ .

In fact, these two invariants were expected to agree when the present work first appeared (cf. [AGW15, Conjecture1.1]) and now we know they do [AGW15, BPW16]:

$$HH_*(\Psi(T)) \cong \text{SKh}(\widehat{T}).$$

Note that for fixed  $n \in \mathbb{Z}^+$ , Chen–Khovanov and Brundan–Stroppel introduced a further grading  $\mathcal{C}(n) = \bigoplus_{k=0}^n \mathcal{C}(n, k)$  on the category  $\mathcal{C}$ . A more precise version of the statement relates the Hochschild homology of the bimodule associated to the category  $\mathcal{C}(n, k)$  with a graded summand  $\text{SKh}(\mathbb{L}; -n + 2k) \subseteq \text{SKh}(\mathbb{L})$ . In [AGW15], the conjecture is proved in the  $k = 1$  case and in [BPW16] the conjecture is proved for all values of  $k$ .

The fact that sutured annular Khovanov homology arises as Hochschild homology of bimodules from  $U_q(\mathfrak{sl}_2)$  categorification indicates that the annular homology groups  $\text{SKh}(\mathbb{L})$  themselves should carry rich structure of representation-theoretic interest. On the other hand, this structure is cumbersome to describe concretely from that point of view. The goal of the present work is to describe some of this structure directly, in down-to-earth terms, without appealing to either Hochschild homology or higher representation theory.

### 1.2 Representation theory and sutured annular Khovanov homology

The most basic of the representation-theoretic structures enjoyed by  $\text{SKh}(\mathbb{L})$  is a linear action of  $\mathfrak{sl}_2$ . We define this  $\mathfrak{sl}_2$  action directly on the chain level and check that it commutes with the annular boundary maps. We further show that this  $\mathfrak{sl}_2$  action is diagram-independent and hence an invariant of the underlying annular link. An amusing corollary of this fact is that the sutured Khovanov homology of an annular link is *trapezoidal* with respect to the  $\mathfrak{sl}_2$  weight space grading (Corollary 1). One conceptual explanation for the  $\mathfrak{sl}_2$  action comes from the conjecture (now proven) that  $\text{SKh}$  can be realized as Hochschild homology of bimodules in  $U_q(\mathfrak{sl}_2)$  categorification (see § 1.3 below).

It turns out that  $\text{SKh}(\mathbb{L})$  has somewhat more symmetry than that provided by the  $\mathfrak{sl}_2$  action. The Lie algebra  $\mathfrak{sl}_2$  is the tangent space to the identity of the Lie group  $\text{SL}_2$ , but if we consider the action of  $\text{SL}_2$  on itself by conjugation, then the quotient stack  $\text{SL}_2//\text{SL}_2$  also has a ‘tangent space’, which is actually a complex of sheaves. The fiber of this complex over the identity has the

<sup>1</sup> The construction of this functor-valued tangle invariant is made more explicit in [CK14] than in [BS11], whose focus is on a relationship between the algebras  $A_n$  and the category  $\mathcal{O}$ .

<sup>2</sup> Asaeda, Przytycki and Sikora [APS04] in fact introduced a version of Khovanov homology for links in thickened oriented surfaces  $F \times I$ . The annular case  $F = A$  was explored further by Roberts in [Rob13], who related it to Heegaard Floer knot homology as in [OS05] (see § 3). This annular theory has come to be known as *sutured annular Khovanov homology* because of a relationship (cf. [GW10b, GW10a]) with Juhász’s sutured version of Heegaard Floer homology [Juh06].

structure of a  $\mathbb{Z}$ -graded Lie superalgebra, which we refer to in this paper as the exterior current algebra of  $\mathfrak{sl}_2$ , and denote  $\mathfrak{sl}_2(\wedge)$ . As a graded vector space, we have

$$\mathfrak{sl}_2(\wedge) = \mathfrak{sl}_2 \oplus \mathfrak{sl}_2[1],$$

with the Lie bracket given essentially by the adjoint action of  $\mathfrak{sl}_2$  on itself (see § 2.2 for a precise definition). The exterior current algebra has appeared and been studied in a number of different contexts, and is sometimes known as a Takiff Lie algebra (see, for example, [GM17] and references therein). Our main result is the following.

**THEOREM 1.** *Let  $\mathbb{L} \subset A \times I$  be an annular link. Then the exterior current algebra  $\mathfrak{sl}_2(\wedge)$  acts linearly on  $\mathrm{SKh}(\mathbb{L})$ , and the isomorphism class of this representation is an annular link invariant.*

The proof of this theorem is direct, as we define the action of the generators of  $\mathfrak{sl}_2(\wedge)$  at the chain level and check that the defining relations hold up to homotopy. An interesting point is that the check of relations uses fundamentally the compatibility of the Khovanov differential and the Lee deformation [Lee05], both with each other and with the additional annular grading of the chain complex. In contrast to the  $\mathfrak{sl}_2$  action on  $\mathrm{SKh}(\mathbb{L})$ , a more conceptual explanation for the appearance of the exterior current algebra from categorified quantum groups and Hochschild homology is missing at the moment.

Given Theorem 1, it is reasonable to reformulate annular Khovanov homology as a functor from the category of annular links (with morphisms the annular link cobordisms) to the category of finite-dimensional graded representations of  $\mathfrak{sl}_2(\wedge)$ . It follows from this description that the  $\mathfrak{sl}_2(\wedge)$ -module structure on  $\mathrm{SKh}(\mathbb{L})$  is an annular link invariant and that annular link cobordisms induce  $\mathfrak{sl}_2(\wedge)$ -module homomorphisms. An important special case is when  $\mathbb{L}$  is the cable of a knot, as in this case the  $\mathfrak{sl}_2(\wedge)$ -module endomorphisms induced by annular link cobordisms have additional structure. We prove the following result, a more precise version of which is stated in § 7.

**THEOREM 2.** *Let  $K \subset S^3$  be a knot and let  $\mathbb{L} = K_{n,nm} \subset A \times I$  denote its  $m$ -framed  $n$ -cable. Then  $\mathrm{SKh}(\mathbb{L})$  carries commuting actions of  $\mathfrak{sl}_2(\wedge)$  and of the symmetric group  $\mathfrak{S}_n$ .*

When  $K$  is the unknot and  $\mathbb{L} = K_{n,0}$  is its Seifert-framed  $n$ -cable, the positive-degree part of  $\mathfrak{sl}_2(\wedge)$  acts trivially, so the  $\mathfrak{sl}_2(\wedge)$  action reduces to an  $\mathfrak{sl}_2$  action, and the commuting actions of  $\mathfrak{sl}_2$  and  $\mathfrak{S}_n$  then recover the usual Schur–Weyl representation on the  $n$ th tensor power of the defining representation of  $\mathfrak{sl}_2$  (cf. § 9.1). Thus, Theorem 2 may be viewed as a generalization of the Schur–Weyl representation to arbitrary framed knots, with the  $\mathfrak{sl}_2$  action in Schur–Weyl duality upgraded to an action of the exterior current algebra.

The topological implications of the exterior current algebra action certainly merit further exploration. We content ourselves here with recalling that the (filtered) annular Khovanov complex is particularly well suited to studying braid conjugacy classes [BG15] and transverse links with respect to the standard tight contact structure on  $S^3$  [Pla06]. In particular, it distinguishes braid closures from the closures of other tangles [GN14] and detects the trivial  $n$ -braid among all  $n$ -braids [BG15]. Moreover, by embedding the solid torus in  $S^3$  in the standard way, one obtains a spectral sequence from the sutured annular Khovanov homology of  $\mathbb{L}$  to the ordinary Khovanov homology of  $\mathbb{L}$ . Although Plamenevskaya’s construction predates annular Khovanov homology, her transverse link invariant [Pla06] is a compelling character in the story described here. Hunt, Keese and Morrison recently wrote a computer program which computes

both the sutured annular Khovanov homology of braid closures as well as the spectral sequence to Khovanov homology. A user’s guide to that program, along with some example computations, can be found in the companion paper [HKLM15].

**1.3 The  $\mathfrak{sl}_2$  action on  $\text{SKh}(\mathbb{L})$  via categorified quantum groups**

Conjecturally,  $\text{SKh}(\mathbb{L})$  can be realized as  $HH_*(\Psi(T))$ , where  $\Psi(T)$  is a complex of bimodules over the Chen–Khovanov/Brundan–Stroppel algebras. This expectation gives rise to one conceptual explanation for the existence of an  $\mathfrak{sl}_2$  action on  $\text{SKh}(\mathbb{L})$ . Namely, on the derived category  $D^b(\mathcal{C}(n))$ , one should be able to define directly an action of the categorified quantum group  $\mathcal{U}(\mathfrak{sl}_2)$  defined by Lauda in [Lau10].<sup>3</sup> The defining 1-morphisms  $E, F$  in Lauda’s 2-category are left and right adjoints to one another, and the adjunction 2-morphisms give rise to endomorphisms

$$e, f : HH_*(Y) \longrightarrow HH_*(Y),$$

where  $Y$  can be taken to be any complex of  $(A_n, A_n)$  bimodules which commutes with the functors  $E$  and  $F$ . (The endomorphisms  $e, f$  are sometimes referred to as Bernstein trace maps [Ber90].) The further structure in Lauda’s 2-category then implies that the maps  $e, f, h = [e, f]$  will satisfy the defining relations of the Lie algebra  $\mathfrak{sl}_2$  [BHLZ17]. In particular, if one takes the functor  $Y$  to be  $\Psi(T)$  for an  $(n, n)$  tangle  $T$ , one should obtain in this way an  $\mathfrak{sl}_2$  action on  $HH_*(\Psi(T))$ . At the moment, it is not clear to us how to use the categorified quantum group to obtain an action of the exterior current algebra directly on  $HH_*(\Psi(T))$ . However, we should note that the closely related *polynomial current algebra* of  $\mathfrak{sl}_2$  does appear in [BHLZ17].

In fact, the entire story above can be generalized from  $\mathfrak{sl}_2$  to  $\mathfrak{sl}_n$  using other representations of Khovanov–Lauda–Rouquier’s categorified quantum groups. The details of this generalization, including a definition of annular  $\mathfrak{sl}_n$  homology and an explicit description of the action of  $\mathfrak{sl}_n$  on the annular homology of any link, have been carried out in recent interesting work of Queffelec and Rose [QR15]. The existence of an  $\mathfrak{sl}_2$  action on the annular Khovanov homology of a link also clarifies the relationship between this homology and the skein module of  $A \times I$ . Namely, the skein module of a 3-manifold  $M$  is isomorphic (at least at  $q = 1$ ) to the coordinate ring of the  $\text{SL}_2$ -character variety of  $\pi_1(M)$  [PS00]. In the case when  $M = A \times I$ , this description essentially reduces to an identification between the skein module of  $A \times I$  and the  $W$ -invariants in the coordinate ring of  $T$ , where here  $W = S_2$  is the Weyl group of  $\text{SL}_2$  and  $T \subset \text{SL}_2$  is the associated maximal torus. Thus, the skein module of  $A \times I$  is isomorphic to  $W$ -invariant functions on  $T$ , which in turn may be identified with the Grothendieck group of the category of representations of  $\mathfrak{sl}_2$ . From this point of view, the precise relationship between  $\text{SKh}$  and the skein module of the annulus naturally involves the representation theory of  $\mathfrak{sl}_2$ . This precise relationship between annular Khovanov homology appears as the  $n = 2$  case in the Queffelec and Rose work [QR15, Proposition 5.9].

**1.4 Organization**

The organization of the paper is as follows.

- In §§ 2 and 3, we recall the definition of sutured Khovanov homology (SKh) for annular links and review some basic facts about the representation theory of  $\mathfrak{sl}_2$  and  $\mathfrak{sl}_2(\wedge)$ .

---

<sup>3</sup> The existence of such an action follows formally from Koszul duality, since there is an explicit categorical action of  $U_q(\mathfrak{sl}_2)$  on the Koszul dual of  $\mathcal{C}(n)$  (see [Web16] and references therein). It would be desirable to describe the action of the generating 2-morphisms of Lauda’s 2-category on  $D^b(\mathcal{C}(n))$  directly, though to our knowledge that has not been done yet.

- In §4, we define the  $\mathfrak{sl}_2$  action on the chain level and prove that the action commutes with the sutured differential and hence induces an action on homology that is diagram-independent. To do this, we reinterpret SKh of an annular link in terms of Bar-Natan’s cobordism category, first extending the Khovanov bracket to the annular setting and then rephrasing the sutured annular Khovanov chain complex CKh as a functor from the annular Bar-Natan cobordism category to a category of graded representations of  $\mathfrak{sl}_2$  (Proposition 1).
- In §5, we describe some basic properties of sutured annular Khovanov homology as an  $\mathfrak{sl}_2$  representation. In particular, we prove that it is trapezoidal with respect to the  $k$  grading, show its functoriality (up to sign) under annular link cobordisms, and explain how the  $\mathfrak{sl}_2$  action at the chain level can be understood via the standard action by marked points.
- In §6, we enlarge the action of  $\mathfrak{sl}_2$  on SKh( $\mathbb{L}$ ) to that of the Lie superalgebra  $\mathfrak{sl}_2(\wedge)$ , and prove that annular link cobordisms induce well-defined morphisms of  $\mathfrak{sl}_2(\wedge)$  modules (Proposition 7). Theorem 1 follows.
- In §7, we prove Theorem 2. We also introduce the inductive limits SKh<sup>even</sup>( $K$ ) and SKh<sup>odd</sup>( $K$ ), which are infinite-dimensional invariants of the knot  $K \subset S^3$ .
- In §8, we give a quiver description of the category of finite-dimensional representations of  $\mathfrak{sl}_2(\wedge)$ , showing directly that these categories are governed by finite-dimensional quadratic (in fact Koszul) algebras.
- In §9, we include some example computations and conjectures.
- In the Appendix, we state and prove the annular version of the Carter and Saito theorem [CS93] needed for the functoriality statements in §5.

## 2. Representation-theoretic preliminaries

### 2.1 $\mathfrak{sl}_2$ and its finite-dimensional representations

We work over  $\mathbb{C}$  throughout. Accordingly, we will denote the Lie algebras  $\mathfrak{gl}_k(\mathbb{C})$  and  $\mathfrak{sl}_k(\mathbb{C})$  by  $\mathfrak{gl}_k$  and  $\mathfrak{sl}_k$ , respectively.

We recall some elementary facts about the finite-dimensional representation theory of the Lie algebra  $\mathfrak{sl}_2$ . The Lie algebra  $\mathfrak{sl}_2$  has a  $\mathbb{C}$ -vector space basis given by the set  $\{e, f, h\}$

$$h = \begin{pmatrix} 1 & 0 \\ 0 & -1 \end{pmatrix}, \quad e = \begin{pmatrix} 0 & 1 \\ 0 & 0 \end{pmatrix}, \quad f = \begin{pmatrix} 0 & 0 \\ 1 & 0 \end{pmatrix},$$

with Lie brackets

$$[e, f] = h, \quad [h, e] = 2e, \quad [h, f] = -2f. \tag{2.1}$$

As a  $\mathbb{C}$ -vector space, any finite-dimensional representation,  $U$ , of  $\mathfrak{sl}_2$  decomposes into *weight spaces*, i.e., into eigenspaces for the action of  $h$ . Explicitly,

$$U := \bigoplus_{\lambda \in \mathbb{Z}} U[\lambda],$$

where

$$U[\lambda] := \{v \in U \mid hv = \lambda v\}.$$

The bracket relations tell us that the generators  $e$  (respectively,  $f$ ) act on the weight spaces as raising (respectively, lowering) operators  $e_\lambda : U[\lambda] \rightarrow U[\lambda + 2]$  (respectively,  $f_\lambda : U[\lambda] \rightarrow U[\lambda - 2]$ ).

Each finite-dimensional irreducible representation of  $\mathfrak{sl}_2$  is determined by its *highest weight*,  $N \in \mathbb{Z}^{\geq 0}$ . Explicitly, for each  $N \in \mathbb{Z}^{\geq 0}$ , one constructs an  $(N + 1)$ -dimensional irreducible representation,  $V_{(N)}$ , with

$$V_{(N)} := \text{Span}_{\mathbb{C}}\{v, fv, \dots, f^N v\}$$

and  $hv = Nv$  (and, hence,  $h(f^i(v)) = (N - 2i)f^i(v)$ ). All finite-dimensional  $\mathfrak{sl}_2$  irreducible representations arise in this manner. The defining two-dimensional irreducible representation  $V_{(1)}$  of  $\mathfrak{sl}_2$ , which plays a central role in what follows, will simply be denoted  $V$ .

### 2.2 The Lie superalgebra $\mathfrak{sl}_2(\wedge)$

A Lie superalgebra is a  $\mathbb{Z}_2$ -graded vector space  $V$  equipped with a bilinear Lie superbracket  $[\cdot, \cdot] : V \times V \rightarrow V$  which satisfies  $\mathbb{Z}_2$ -graded versions of usual Lie algebra axioms:

- (Super skew symmetry)  $[x, y] = (-1)^{|x||y|}[y, x]$ ;
- (Super Jacobi identity)  $[x, [y, z]] = [[x, y], z] + (-1)^{|x||y|}[y, [x, z]]$ .

A  $\mathbb{Z}$ -graded Lie superalgebra is a Lie superalgebra  $V$  with a  $\mathbb{Z}$  grading  $V = \bigoplus_{n \in \mathbb{Z}} V(n)$  compatible with both the Lie superbracket, so that for  $x \in V(n)$  and  $y \in V(m)$ ,  $[x, y] \in V(n+m)$ , and with the  $\mathbb{Z}_2$  grading on  $V$ , so that the subspaces  $V(2n)$  are in the degree-0 part of the  $\mathbb{Z}_2$  grading, while the subspaces  $V(2n + 1)$  are in degree 1.

We now describe the exterior current algebra  $\mathfrak{sl}_2(\wedge)$ , which is a  $\mathbb{Z}$ -graded Lie superalgebra, by generators and relations. We have

$$\mathfrak{sl}_2(\wedge) \cong \mathfrak{sl}_2 \oplus \mathfrak{sl}_2,$$

with the first summand in degree 0 and the second in degree 1 for the  $\mathbb{Z}$  (and  $\mathbb{Z}_2$ ) gradings. We fix the standard  $\{e, f, h\}$  basis of  $\mathfrak{sl}_2$ ; in order to distinguish the two distinct  $\mathfrak{sl}_2$  summands in  $\mathfrak{sl}_2(\wedge)$  from each other, we will write the standard basis of the degree-1 summand as  $\{v_2, v_{-2}, v_0\}$ . In this basis, the adjoint action of  $\mathfrak{sl}_2$  is

$$\begin{aligned} e(v_2) &= 0, & e(v_0) &= -2v_2, & e(v_{-2}) &= v_0, \\ f(v_2) &= -v_0, & f(v_0) &= 2v_{-2}, & f(v_{-2}) &= 0. \end{aligned}$$

Thus, in the basis  $\{e, f, h, v_2, v_{-2}, v_0\}$ , the Lie superalgebra  $\mathfrak{sl}_2(\wedge)$  has defining relations:

- $[e, f] = h$ ;
- $[h, e] = 2e$ ;
- $[h, f] = -2f$ ;
- $[e, v_2] = 0$ ;
- $[e, v_0] = -2v_2$ ;
- $[e, v_{-2}] = v_0 = -[f, v_2]$ ;
- $[f, v_0] = 2v_{-2}$ ;
- $[f, v_{-2}] = 0$ ;
- $[h, v_2] = 2v_2$ ;
- $[h, v_0] = 0$ ;
- $[h, v_{-2}] = -2v_{-2}$ ;
- $[v_i, v_j] = 0$  for  $i, j \in \{2, 0, -2\}$ .

The  $\mathbb{Z}$  and  $\mathbb{Z}_2$  gradings on  $\mathfrak{sl}_2(\wedge)$  induce  $\mathbb{Z}$  and  $\mathbb{Z}_2$  gradings on its enveloping algebra  $U(\mathfrak{sl}_2(\wedge))$ .

## 3. Topological preliminaries

### 3.1 Sutured annular Khovanov homology and Lee homology

Let  $A$  be a closed, oriented annulus and  $I = [0, 1]$  the closed, oriented unit interval. Via the identification

$$A \times I = \{(r, \theta, z) \mid r \in [1, 2], \theta \in [0, 2\pi), z \in [0, 1]\} \subset (S^3 = \mathbb{R}^3 \cup \infty),$$

any link,  $\mathbb{L} \subset A \times I$ , may naturally be viewed as a link in the complement of a standardly embedded unknot,  $(U = z\text{-axis} \cup \infty) \subset S^3$ . Such an *annular link*  $\mathbb{L} \subset A \times I$  admits a diagram,  $\mathcal{P}(\mathbb{L}) \subset A$ , obtained by projecting a generic isotopy class representative of  $\mathbb{L}$  onto  $A \times \{1/2\}$ , and from this diagram one can construct a triply graded chain complex,  $\text{CKh}(\mathcal{P}(\mathbb{L}))$ , using a version of Khovanov’s original construction [Kho00] due to Asaeda, Przytycki and Sikora [APS04] and Roberts [Rob13] (see also [GW10a]), briefly recalled here.

View  $\mathcal{P}(\mathbb{L}) \subset A$  instead as a diagram on  $S^2 - \{\mathbb{X}, \mathbb{O}\}$ , where  $\mathbb{X}$  (respectively,  $\mathbb{O}$ ) are base points on  $S^2$  corresponding to the inner (respectively, outer) boundary circles of  $A$ . If we temporarily forget the data of  $\mathbb{X}$ , we may view  $\mathcal{P}(\mathbb{L})$  as a diagram on  $\mathbb{R}^2 = S^2 - \{\mathbb{O}\}$  and form the ordinary bigraded Khovanov complex

$$\text{CKh}(\mathcal{P}(\mathbb{L})) = \bigoplus_{(i,j) \in \mathbb{Z}^2} \text{CKh}^i(\mathcal{P}(\mathbb{L}); j),$$

as described in [Kho00].

Recall that the generators of  $\text{CKh}(\mathcal{P}(\mathbb{L}))$  correspond to oriented Kauffman states (cf. [GW11, § 4.2]). That is, in the language of [Bar05], we identify a ‘ $v_+$ ’ (respectively, a ‘ $v_-$ ’) marking on a component of a Kauffman state with a counterclockwise (respectively, clockwise) orientation on that component. We now obtain a third grading on the complex by defining the ‘ $k$ ’ grading of a generator (up to an overall shift) to be the algebraic intersection number of the corresponding oriented Kauffman state with a fixed oriented arc  $\gamma$  from  $\mathbb{X}$  to  $\mathbb{O}$  that misses all crossings of  $\mathcal{P}(\mathbb{L})$ . Note (see [Rob13, § 2]) that component circles of a Kauffman state are either *trivial* (intersect the arc  $\gamma$  from  $\mathbb{X}$  to  $\mathbb{O}$  in an even number of points) or *non-trivial* (intersect  $\gamma$  in an odd number of points). Roberts proved (see [Rob13, Lemma 1]) that the Khovanov differential,  $\partial$ , is non-increasing in this extra grading. Decomposing  $\partial = \partial_0 + \partial_-$  into its  $k$ -grading-preserving and  $k$ -grading-decreasing parts, we obtain a triply graded chain complex  $(\text{CKh}(\mathcal{P}(\mathbb{L})), \partial_0)$  whose homology,

$$\text{SKh}(\mathbb{L}) := \bigoplus_{(i,j,k) \in \mathbb{Z}^3} \text{SKh}^i(\mathbb{L}; j, k),$$

is an invariant of  $\mathbb{L} \subset A \times I$ , called the *sutured annular Khovanov homology* of  $\mathbb{L}$ . More can be said, as shown in the following lemma.

LEMMA 1. *Let  $\text{CKh}(\mathcal{P}(\mathbb{L}))$  be the triply graded vector space associated to a diagram of an annular link,  $\mathbb{L} \subset A \times I$  as above, and let  $\partial = \partial_0 + \partial_-$  be the decomposition of the Khovanov differential in terms of the  $k$  grading. Then  $(\text{CKh}(\mathcal{P}(\mathbb{L})), \partial_0, \partial_-)$  is a bicomplex.*

*Proof.* The operator  $\partial_0$  is homogeneous of degree 0 (respectively,  $\partial_-$  is homogeneous of degree  $-2$ ) in the  $k$  grading. Decomposing  $\partial^2 = 0$  into its  $k$ -homogeneous summands, it follows that  $\partial_-^2 = 0$  and  $\partial_0 \partial_- + \partial_- \partial_0 = 0$ . □

One therefore obtains a spectral sequence converging to  $\text{Kh}(\mathbb{L})$  whose  $E^1$  page is  $\text{SKh}(\mathbb{L})$ . Each page of this spectral sequence is an invariant of  $\mathbb{L} \subset A \times I$  (cf. [Rob13]).

The reader is warned that the other spectral sequence associated to this bicomplex (whose  $E^1$  page is the homology of  $(\text{CKh}(\mathcal{P}(\mathbb{L}), \partial_-)$ ) is *not* an invariant of the annular link  $\mathbb{L}$ ).

*Remark 1.* In [Rob13], the complex  $\text{CKh}(\mathcal{P}(\mathbb{L}))$  is considered as a *filtered* complex, with the filtration induced by the  $k$  grading. This filtration agrees with the standard one associated to the bicomplex described above.



*Remark 2.* In what follows it will be convenient for us to replace Khovanov’s original ‘ $j$ ’ (quantum) grading with a ‘ $j'$ ’ (filtration-adjusted quantum) grading. If  $\mathbf{x} \in \text{CKh}(\mathcal{P}(\mathbb{L}))$  is a generator,  $j'(\mathbf{x}) := j(\mathbf{x}) - k(\mathbf{x})$ . The sutured differential,  $\partial_0$ , has degree  $(1, 0, 0)$  with respect to the  $(i, j', k)$  grading, while the endomorphism  $\partial_-$  has degree  $(1, 2, -2)$ .

The chain complex  $\text{CKh}(\mathcal{P}(\mathbb{L}))$  also comes equipped with a natural involution  $\Theta$ , defined in the following lemma (cf. [AGW14, Proposition 7.2(3)]).

LEMMA 2. *Let  $\mathbb{L} \subset (A \times I) \subset S^3$  be an annular link,*

$$\mathcal{P}(\mathbb{L}) \subset (S^2 - \mathbb{O} - \mathbb{X}) \subset (S^2 - \mathbb{O}) \sim \mathbb{R}^2$$

*a diagram for  $\mathbb{L}$ , and*

$$\mathcal{P}'(\mathbb{L}) \subset (S^2 - \mathbb{X} - \mathbb{O}) \subset (S^2 - \mathbb{X}) \sim \mathbb{R}^2$$

*the diagram obtained by exchanging the roles of  $\mathbb{O}$  and  $\mathbb{X}$ . The corresponding map*

$$\Theta : \text{CKh}(\mathcal{P}(\mathbb{L}), \partial_0) \rightarrow \text{CKh}(\mathcal{P}'(\mathbb{L}), \partial_0)$$

*is a chain isomorphism inducing an isomorphism  $\text{SKh}^{i,j'}(L; k) \cong \text{SKh}^{i,j'}(L; -k)$  for all  $(i, j', k) \in \mathbb{Z}^3$ .*

*Proof.* Recall that the generators of the sutured Khovanov complex are identified with enhanced (oriented) Kauffman states. Therefore, the result of preserving the orientation on  $S^2$  but exchanging the roles of  $\mathbb{O}$  and  $\mathbb{X}$  is that:

- the orientation on the arc  $\gamma$  is reversed; and
- a counterclockwise (respectively, clockwise) orientation on a non-trivial circle is now viewed as a clockwise (respectively, counterclockwise) orientation.

On the other hand, orientations on all *trivial* components are preserved. In the language of [Rob13] and [GW11],  $v_+$  and  $v_-$  labels are exchanged on non-trivial components but preserved on trivial components of an oriented Kauffman state. Since the sutured Khovanov differential,  $\partial_0$ , is symmetric with respect to  $v_{\pm}$  labelings on non-trivial circles (cf. [Rob13, § 2]),  $\Theta$  is a chain map.

Moreover,  $\Theta \circ \Theta = \mathbb{1}$ , so it is a chain isomorphism. That it preserves the homological ( $i$ ) and new quantum ( $j'$ ) gradings but changes the sign of the weight space ( $k$ ) grading is immediate from the definition. □

Let  $\Phi$  denote Lee’s deformation of Khovanov’s differential, defined in [Lee05, § 4]. Explicitly, for an elementary merge cobordism,  $\Phi$  maps a  $v_- \otimes v_-$  marking to a  $v_+$  marking on the circles involved in the cobordism, and every other labeling is mapped to 0. Similarly, for an elementary split cobordism,  $\Phi$  maps a  $v_-$  marking to  $v_+ \otimes v_+$  and every other labeling is mapped to 0. Lee proved that:

- $\Phi^2 = 0$ ;
- $\partial\Phi + \Phi\partial = 0$ .

As with the Khovanov differential above, we may write the Lee deformation as a sum

$$\Phi = \Phi_0 + \Phi_+,$$

where this time  $\Phi_0$  has  $(i, j', k)$  degree  $(1, 4, 0)$ , while  $\Phi_+$  has degree  $(1, 2, 2)$ .

One may check directly along the various split and merge maps in the cube that  $\Theta$  commutes with  $\partial_0$  and  $\Phi_0$ , and that conjugation by  $\Theta$  exchanges  $\partial_-$  and  $\Phi_+$ . This observation, together with the equations that arise by writing the  $k$ -homogeneous components of the equations  $\partial^2 = 0$ ,  $(\Phi)^2 = 0$ , and  $\partial\Phi + \Phi\partial = 0$ , result in a number of relations involving  $\partial_0, \partial_-, \Phi_0, \Phi_+$ , and  $\Theta$ . We collect these relationships in the following.

LEMMA 3. *The endomorphisms  $\partial_0, \partial_-, \Phi_0, \Phi_+$ , and  $\Theta$  of  $\text{CKh}(\mathcal{P}(\mathbb{L}))$  satisfy the following:*

- (1)  $\partial_0^2 = (\Phi_0)^2 = 0$ ;
- (2)  $\partial_-^2 = (\Phi_+)^2 = 0$ ;
- (3)  $\Theta\partial_0 = \partial_0\Theta$ ;
- (4)  $\Theta\Phi_0 = \Phi_0\Theta$ ;
- (5)  $\Theta\partial_- = \Phi_+\Theta$ ;
- (6)  $\partial_-\partial_0 + \partial_0\partial_- = 0$ ;
- (7)  $\Phi_+\Phi_0 + \partial_0\Phi_+ = 0$ ;
- (8)  $\Phi_+\partial_0 + \partial_0\Phi_+ = 0$ ;
- (9)  $\partial_-\Phi_0 + \Phi_0\partial_- = 0$ ;
- (10)  $\partial_0\Phi_0 + \Phi_0\partial_0 + \partial_-\Phi_+ + \Phi_+\partial_- = 0$ .

#### 4. A sutured annular Khovanov bracket and $\mathfrak{sl}_2$

##### 4.1 Khovanov bracket for annular links

Let  $\mathbb{L} \subset A \times I$  be an annular link and  $\mathcal{P}(\mathbb{L}) \subset A$  a diagram for  $\mathbb{L}$ , as in the previous subsection. Following Bar-Natan [Bar05, §§ 2 and 11], one can define an abstract chain complex

$$[\mathcal{P}(\mathbb{L})] = (\dots \longrightarrow [\mathcal{P}(\mathbb{L})]^{i-1} \longrightarrow [\mathcal{P}(\mathbb{L})]^i \longrightarrow [\mathcal{P}(\mathbb{L})]^{i+1} \longrightarrow \dots)$$

by constructing a resolution cube for  $\mathcal{P}(\mathbb{L})$  and then formally taking direct sums of resolutions that sit in the same ‘ $i$ ’ degree. The differential in this complex is defined in terms of (signed) saddle cobordisms associated to the edges of the resolution cube, and the resulting complex,  $[\mathcal{P}(\mathbb{L})]$ , is viewed as an object in the category  $\text{Kom}_{/h}(\text{Mat}(\text{Cob}^3_\ell(A)))$ , defined below.

DEFINITION 1. Let  $\text{Cob}^3(A)$  denote the category whose objects are closed, unoriented 1-manifolds in  $A$ , and whose morphisms between two objects  $C_0$  and  $C_1$  are unoriented 2-cobordisms  $S \subset A \times I$  satisfying  $\partial S = (C_0 \times \{0\}) \amalg (C_1 \times \{1\})$ , considered up to isotopy rel boundary. Let  $\text{Cob}^3_\ell(A)$  denote the category which has the same objects as  $\text{Cob}^3(A)$  and whose morphisms are formal  $\mathbb{C}$ -linear combinations of morphisms in  $\text{Cob}^3(A)$ , considered modulo the  $S, T$ , and  $4Tu$  relations described in [Bar05, § 4.1].

DEFINITION 2. For a pre-additive category  $\mathcal{A}$ , we denote by  $\text{Mat}(\mathcal{A})$  the additive closure of  $\mathcal{A}$ . If  $\mathcal{A}$  is an additive category, then we denote by  $\text{Kom}_{/h}(\mathcal{A})$  the bounded homotopy category of  $\mathcal{A}$ .

We will use the shorthand notation  $\text{Kob}_{/h}(A) := \text{Kom}_{/h}(\text{Mat}(\text{Cob}^3_\ell(A)))$ , and we will write  $\text{Kob}_{/\pm h}(A)$  for the (non-additive) category obtained from  $\text{Kob}_{/h}(A)$  by identifying each morphism with its negative. Bar-Natan proved in [Bar05] that the homotopy type of the complex  $[\mathcal{P}(\mathbb{L})]$  is invariant under Reidemeister moves, and thus the object  $[\mathcal{P}(\mathbb{L})] \in \text{Kob}_{/h}(A)$  provides an invariant for the annular link  $\mathbb{L} \subset A \times I$  when considered up to isomorphism in  $\text{Kob}_{/h}(A)$ . We will see in Proposition 4 below that  $[\mathcal{P}(\mathbb{L})]$  also has good functoriality properties.

*Remark 3.* The category  $Cob^3_{/\ell}(A)$  can be transformed into a graded category by replacing objects of  $Cob^3_{/\ell}(A)$  by pairs  $(C, j')$ , where  $C \in Cob^3_{/\ell}(A)$  and where  $j'$  is an integer, to be thought of as a formal grading shift. In the remainder of this paper, we will implicitly assume that  $Cob^3_{/\ell}(A)$  is this graded category, and that  $[\mathcal{P}(\mathbb{L})]$  is the graded version of the annular Khovanov bracket (defined as in [Bar05, § 6]).

**4.2 CKh as a TQFT valued in representations of  $\mathfrak{sl}_2$**

Let  $\text{gRep}(\mathfrak{sl}_2)$  denote the category of  $\mathbb{Z}$ -graded representations of  $\mathfrak{sl}_2$ . An object of  $\text{gRep}(\mathfrak{sl}_2)$  is a direct sum

$$Y = \bigoplus_{n \in \mathbb{Z}} Y(n),$$

where each  $Y(n)$  is a finite-dimensional representation of  $\mathfrak{sl}_2$ . An object  $Y \in \text{gRep}(\mathfrak{sl}_2)$  is sometimes naturally regarded as a *bigraded* vector space, where the component gradings are the  $\mathbb{Z}$  grading above and the  $\mathfrak{sl}_2$  weight space grading. These component gradings will be referred to as the  $j'$  and  $k$  gradings, respectively (in particular,  $k$  grading means  $\mathfrak{sl}_2$ -weight-space grading). For  $m \in \mathbb{Z}$ , we will denote by  $\{m\}$  the grading shift operator which acts on objects of  $\text{gRep}(\mathfrak{sl}_2)$  by raising the  $j'$  grading by  $m$ . That is, if  $Y$  is an object of  $\text{gRep}(\mathfrak{sl}_2)$ , then  $Y\{m\}$  denotes the object with components  $(Y\{m\})(n+m) := Y(n)$ .

We will define a  $(1+1)$ -dimensional annular TQFT with values in  $\text{gRep}(\mathfrak{sl}_2)$  (where by a  $(1+1)$ -dimensional annular TQFT, we here mean any sufficiently nice functor from the category  $Cob^3(A)$  to a category of vector spaces, possibly equipped with extra structure). In order to define this annular TQFT, we will need to use three particular graded representations of  $\mathfrak{sl}_2$ .

- Let

$$V := \text{Span}_{\mathbb{C}}\{v_+, v_-\}$$

denote the two-dimensional defining representation of  $\mathfrak{sl}_2$ . The bigrading on  $V$  is  $j'(v_{\pm}) = 0$  and  $k(v_{\pm}) = \pm 1$ ; in particular,  $v_+$  is a highest-weight vector and  $v_- = f \cdot v_+$  a lowest-weight vector.

- Let

$$V^* := \text{Span}_{\mathbb{C}}\{\bar{v}_+, \bar{v}_-\}$$

denote the dual representation to  $V$ , where  $\bar{v}_-$  is the dual vector to  $v_+$  and  $\bar{v}_+$  is the dual vector to  $v_-$ . The bigrading on  $V^*$  is  $j'(\bar{v}_{\pm}) = 0$  and  $k(\bar{v}_{\pm}) = \pm 1$ .

- Let

$$W := \text{Span}_{\mathbb{C}}\{w_+, w_-\}$$

be the trivial two-dimensional representation of  $\mathfrak{sl}_2$ , graded with  $j'(w_{\pm}) = \pm 1$  and  $k(w_{\pm}) = 0$ .

Of course, the objects  $V$  and  $V^*$  are isomorphic in  $\text{gRep}(\mathfrak{sl}_2)$ . However, the matrices for the action of the standard basis  $\{e, f, h\}$  with respect to the bases  $\{v_{\pm}\}$  on  $V$  and  $\{\bar{v}_{\pm}\}$  on  $V^*$  are different; explicitly, the actions on  $V$  and  $V^*$  are given by

$$e \cdot v_- = v_+, \quad f \cdot v_+ = v_-, \quad e \cdot v_+ = f \cdot v_- = 0, \quad h \cdot v_{\pm} = \pm v_{\pm}$$

and

$$e \cdot \bar{v}_- = -\bar{v}_+, \quad f \cdot \bar{v}_+ = -\bar{v}_-, \quad e \cdot \bar{v}_+ = f \cdot \bar{v}_- = 0, \quad h \cdot \bar{v}_{\pm} = \pm \bar{v}_{\pm}.$$

(Note also that Khovanov’s ‘ $j$ ’ grading used in [Rob13] is the sum of the ‘ $j'$ ’ and the ‘ $k$ ’ gradings. See Remark 2.)

We will now define an additive functor

$$\mathcal{F}: Cob^3_{/\ell}(A) \longrightarrow \text{gRep}(\mathfrak{sl}_2).$$

4.2.1  $\mathcal{F}$  on objects. We refer to a compact, connected 1-manifold embedded in  $A$  as a trivial circle if it represents 0 in  $H_1(A, \mathbb{Z})$ , and refer to it as a non-trivial circle otherwise. Thus, any unoriented 1-manifold embedded in  $A$  is a disjoint union of trivial circles and non-trivial circles. Let  $C \in \mathcal{Cob}^3_{\ell}(A)$  be an unoriented 1-manifold  $C \subset A$ , with  $\ell_n$  non-trivial circles and  $\ell_t$  trivial circles. Enumerate the circles of  $C$  as  $C_1, \dots, C_{\ell_n + \ell_t}$ , and regard  $C$  as a submanifold of  $S^2 - \mathbb{X} - \mathbb{O}$ , where  $\mathbb{X}$  (respectively,  $\mathbb{O}$ ) is a base point on  $S^2$  corresponding to the inner (respectively, outer) boundary of  $A$ , as in §3.1. For a non-trivial circle  $C_i$ , we denote by  $X(C_i) \in \{0, \dots, \ell_n - 1\}$  the number of non-trivial circles of  $C$  which lie in the same component of  $S^2 - C_i$  as the base point  $\mathbb{X}$ , and we define

$$\epsilon(C_i) := (-1)^{X(C_i)}.$$

We now set

$$\mathcal{F}(C) := \left( \bigotimes_{\epsilon(C_i)=1} V \right) \otimes \left( \bigotimes_{\epsilon(C_i)=-1} V^* \right) \otimes \left( \bigotimes_{s=1}^{\ell_t} W \right).$$

Thus, non-trivial circles  $C_i$  are assigned either  $V$  or  $V^*$ , depending on the sign  $\epsilon(C_i)$ , and trivial circles are assigned  $W$ .

4.2.2  $\mathcal{F}$  on morphisms. To define  $\mathcal{F}$  on morphisms, we use that morphisms of  $\mathcal{Cob}^3_{\ell}(A)$  are generated by elementary Morse cobordisms: cup cobordisms creating a trivial circle, cap cobordisms annihilating a trivial circle, and saddle cobordisms, which either merge two circles into one or split one circle into two. To saddle cobordisms, we now assign the merge/split maps defined by Roberts in [Rob13, §2]; to cup cobordisms, we assign the map  $\iota: \mathbb{C} \rightarrow W$  given by  $\iota(1) := w_+$ ; to cap cobordisms, we assign the map  $\tilde{\epsilon}: W \rightarrow \mathbb{C}$  given by  $\tilde{\epsilon}(w_+) := 0$  and  $\tilde{\epsilon}(w_-) := 1$ .

There are two points about the above definition that require explanation. The first is that the above assignment to cups, caps, and saddles induces a well-defined linear map on any annular cobordism. To see this, note that  $\iota$  and  $\tilde{\epsilon}$  are precisely the unit and co-unit maps defined by Khovanov in [Kho00]. Roberts further shows that his merge/split maps can be viewed as the degree-0 parts (with respect to the ‘ $k$ ’ filtration) of Khovanov’s multiplication/comultiplication maps. More precisely, let  $\phi$  be a linear map between graded vector spaces which is filtered for the filtration induced by the grading (so that the matrix of  $\phi$  is block upper-triangular when written in a basis consisting of graded-homogeneous vectors).<sup>4</sup> Let  $\mathcal{G}(\phi)$  be the degree-0 part of  $\phi$ . Note that the degree-0 part of a filtered map  $\phi$  between graded vector spaces  $V$  and  $W$  depends only on the map  $\phi$  and on the gradings on  $V$  and  $W$ . In particular, if two filtered maps  $\phi$  and  $\psi$  between graded vector spaces  $V$  and  $W$  are equal to each other as linear maps, then so, too, are their degree-0 parts equal. Moreover, taking the degree-0 part of a filtered map is an operation which commutes with composition. The assignment  $\phi \mapsto \mathcal{G}(\phi)$  is thus a functor from filtered linear maps between graded vector spaces to linear maps between vector spaces. It now follows from what Roberts shows that  $\mathcal{F}$  can be written as  $\mathcal{F} = \mathcal{G} \circ \mathcal{F}^{Kh}$ , where  $\mathcal{F}^{Kh}$  is Khovanov’s  $(1+1)$ -dimensional TQFT [Kho00], viewed as a functor from  $\mathcal{Cob}^3_{\ell}(A)$  to the category of graded vector spaces and filtered linear maps between graded vector spaces (graded by the  $k$  grading). Since the latter functor is well defined, it follows that  $\mathcal{F}$  is well defined as well. In particular, this argument shows that the map  $\mathcal{F}(S)$  associated to a cobordism  $S$  is independent of how  $S$  is decomposed into elementary cobordisms (cups, caps, and saddles).

<sup>4</sup> Here by a filtered map we mean a map between graded vector spaces which is non-increasing with respect to the gradings. Being filtered is thus a property of a map, not an additional structure.

The second point is to observe that the linear maps that  $\mathcal{F}$  assigns to generating morphisms of  $\mathcal{Cob}_{\ell}^3(A)$  (cup, cap, and saddle cobordisms in  $A \times I$ ) are maps of  $\mathfrak{sl}_2$ -modules, so that the functor  $\mathcal{F}$  can be regarded as taking values in  $\text{gRep}(\mathfrak{sl}_2)$ . For cup and cap cobordisms in  $A \times I$ , this is obvious, because the ‘non-identity parts’ of these cobordisms only involve trivial circles, and hence the ‘non-identity parts’ of the associated linear maps only involve  $W$  factors, on which the  $\mathfrak{sl}_2$  action is trivial. For saddle cobordisms in  $A \times I$ , we have the following lemma.

LEMMA 4. *With the above assignment of  $\mathfrak{sl}_2$ -module structures to the vector spaces  $\mathcal{F}(C)$ , each merge/split map (defined as in [Rob13, § 2]):*

$$\begin{aligned} W \otimes W &\longleftrightarrow W, \\ W \otimes V &\longleftrightarrow V, \\ W \otimes V^* &\longleftrightarrow V^*, \\ V \otimes V^* &\longleftrightarrow W \end{aligned}$$

is an  $\mathfrak{sl}_2$ -module map of  $(j', k)$ -bidegree  $(-1, 0)$ .

*Proof.* Since  $W$  is a direct sum of trivial  $\mathfrak{sl}_2$ -modules, there is nothing to check for line (1). Lines (2) and (3) have essentially the same proof. For example, in line (2) we have

$$V^{*\otimes x} \otimes V^{\otimes y} \otimes (V \otimes W) \otimes W^{\otimes z} \xrightarrow{\mathbb{1} \otimes \dots \otimes \mathbb{1} \otimes (\Phi) \otimes \mathbb{1}} V^{*\otimes x} \otimes V^{\otimes y} \otimes (V) \otimes W^{\otimes z},$$

where  $\Phi$  is either the merge or split map, depending on the direction of the arrow, and

$$V \otimes W := V\{-1\} \oplus V\{1\}$$

is a direct sum of two irreducible graded representations of  $\mathfrak{sl}_2$ .

If  $C$  (respectively,  $C'$ ) is the non-trivial circle involved in the merge/split before (respectively, after) the merge/split, then  $\epsilon(C) = \epsilon(C')$  because the number of non-trivial circles in the same component of  $S^2 - C$  as  $\mathbb{X}$  is unchanged by merging/splitting with a trivial circle.

It follows that the Roberts merge (respectively, split) map is precisely the canonical degree- $(0, 0)$  projection of  $\mathfrak{sl}_2$  representations:

$$V\{-1\} \oplus V\{1\} \longrightarrow V\{1\}$$

(respectively, inclusion):

$$V\{0\} \longrightarrow V\{0\} \oplus V\{2\}.$$

For line (4), we have

$$V^{*\otimes x} \otimes V^{\otimes y} \otimes (V \otimes V^*) \otimes W^{\otimes z} \xrightarrow{\mathbb{1} \otimes \dots \otimes \mathbb{1} \otimes (\Phi) \otimes \mathbb{1}} V^{*\otimes x} \otimes V^{\otimes y} \otimes (W) \otimes W^{\otimes z},$$

where  $\Phi$  again denotes the merge or split, depending on the direction of the arrow, and

$$V \otimes V^* := V_{(0)} \oplus V_{(2)}$$

is the decomposition into the irreducible trivial ( $V_{(0)}$ ) and adjoint ( $V_{(2)}$ )  $\mathfrak{sl}_2$  representations. Let  $C_1$  and  $C_2$  denote the two non-trivial circles involved in the merge; then, since  $C_1$  is adjacent to  $C_2$ , we have  $-\epsilon(C_1) = \epsilon(C_2)$ . Moreover, with respect to the chosen bases of  $V, V^*$ , we have

$$V_{(0)} = \text{Span}_{\mathbb{C}}\{v_+ \otimes \bar{v}_- + v_- \otimes \bar{v}_+\} \subset V \otimes V^*.$$

We conclude that the merge and split maps are non-zero scalar multiples of the composition of inclusion and projection maps

$$V_{(0)} \longleftrightarrow V \otimes V^*.$$

We have shown that each vector space  $\mathcal{F}(C)$  can be given the structure of a graded  $\mathfrak{sl}_2$ -module, and that the maps associated to morphisms of  $\mathcal{Cob}_\ell^3(A)$  intertwine the  $\mathfrak{sl}_2$  actions. Hence,  $\mathcal{F}$  lifts to a functor with values in  $\text{gRep}(\mathfrak{sl}_2)$ , as desired.  $\square$

*Remark 4.* In fact the functor  $\mathcal{F}$  can take values in the category of graded representations of  $\mathfrak{gl}_2$ , after declaring  $V$  to be the defining two-dimensional representation of  $\mathfrak{gl}_2$ ,  $V^*$  the linear dual, and  $W$  the trivial two-dimensional representation. In some sense, the distinction between  $V$  and  $V^*$  in the construction is more natural when  $\mathcal{F}$  takes values in  $\text{gRep}(\mathfrak{gl}_2)$ , since  $V$  and  $V^*$  are no longer isomorphic as  $\mathfrak{gl}_2$  representations. On the other hand, the exterior current algebra which appears later in the paper is that of  $\mathfrak{sl}_2$ , not  $\mathfrak{gl}_2$ .

We now have the following.

**PROPOSITION 1.** *The sutured annular Khovanov complex can be obtained from the annular Khovanov bracket by applying the functor  $\mathcal{F}$ :*

$$(\text{CKh}(\mathcal{P}(\mathbb{L})), \partial_0) \cong \mathcal{F}([\mathcal{P}(\mathbb{L})]).$$

*Proof.* This follows immediately from the definition and properties of  $\mathcal{F}$  and from the definitions of  $[\mathcal{P}(\mathbb{L})]$  and  $(\text{CKh}(\mathcal{P}(\mathbb{L})), \partial_0)$  given in [Bar05] and [Rob13], respectively.  $\square$

The above proposition implies that the sutured annular Khovanov complex of  $\mathcal{P}(\mathbb{L})$  can be viewed as a complex in the category  $\text{gRep}(\mathfrak{sl}_2)$ . We can refine this result by introducing the Schur algebra

$$S(2, n) := \text{im}(\rho_n),$$

where  $\rho_n: U(\mathfrak{sl}_2) \rightarrow \text{End}_{\mathbb{C}}(V_{(1)}^{\otimes n})$  denotes the usual representation of  $U(\mathfrak{sl}_2)$  on the  $n$ th tensor power of the defining representation of  $\mathfrak{sl}_2$ .

**PROPOSITION 2.** *If there exists an essential arc  $\gamma \subset A$  intersecting  $\mathcal{P}(\mathbb{L}) \subset A$  transversely in exactly  $n$  points, none of which are crossings of  $\mathcal{P}(\mathbb{L})$ , then the  $\mathfrak{sl}_2$  action on  $\text{CKh}(\mathcal{P}(\mathbb{L}))$  factors through the Schur algebra  $S(2, n)$ .*

*Proof.* Suppose that there is an arc  $\gamma$  as in the proposition. Then the number  $\ell_n$  of non-trivial circles in any given resolution  $C$  of  $\mathcal{P}(\mathbb{L})$  satisfies

$$0 \leq \ell_n \leq n \quad \text{and} \quad \ell_n \equiv n \pmod{2}$$

and hence the representation

$$V_{(1)}^{\otimes n} = V_{(1)}^{\otimes \ell_n} \otimes V_{(1)}^{\otimes (n-\ell_n)}$$

contains a copy of the representation  $V_{(1)}^{\otimes \ell_n}$  because  $V_{(1)}^{\otimes (n-\ell_n)}$  contains a copy of the trivial representation. It therefore follows that elements of  $\ker(\rho_n) \subset U(\mathfrak{sl}_2)$  act trivially on  $V_{(1)}^{\otimes \ell_n}$ .

Now, as abstract  $\mathfrak{sl}_2$  representations, the spaces  $V$  and  $V^*$  used in the definition of  $\text{CKh}(\mathcal{P}(\mathbb{L}))$  satisfy  $V \cong V^* \cong V_{(1)}$ ; thus, as an abstract  $\mathfrak{sl}_2$  representation,  $\mathcal{F}(C) \cong V^{\otimes \ell_n} \otimes W^{\otimes \ell_t}$  is isomorphic to a direct sum of  $2^{\ell_t}$  copies of  $V_{(1)}^{\otimes \ell_n}$ , and it follows that the  $\mathfrak{sl}_2$  action on  $\mathcal{F}(C)$  factors through  $U(\mathfrak{sl}_2)/\ker(\rho_n) \cong \text{im}(\rho_n) = S(2, n)$ .  $\square$

Passing to homology, Propositions 1 and 2 immediately imply the following.

**PROPOSITION 3.** *We have  $\mathrm{SKh}^i(\mathcal{P}(\mathbb{L})) \cong H_i(\mathcal{F}([\mathcal{P}(\mathbb{L}]))) \in \mathrm{gRep}(\mathfrak{sl}_2)$  for all  $i$ , so that  $\mathrm{SKh}(\mathcal{P}(\mathbb{L}))$  is a bigraded representation of  $\mathfrak{sl}_2$ . The isomorphism type of this bigraded representation is an invariant of the isotopy class of the annular link  $\mathbb{L}$ . The action of  $\mathfrak{sl}_2$  on  $\mathrm{SKh}(\mathbb{L})$  factors through the Schur algebra  $S(2, n)$ , where  $n$  is the wrapping number of  $\mathbb{L}$ .*

Here the wrapping number of an annular link  $\mathbb{L} \subset A \times I$  is defined as the smallest integer  $n \geq 0$  such that there exists an arc  $\gamma \subset A$  as in Proposition 2, where the minimum is taken over all diagrams  $\mathcal{P}(\mathbb{L}) \subset A$  representing the annular link  $\mathbb{L}$ .

The above proposition will be strengthened by enlarging the action of  $\mathfrak{sl}_2$  to an action of  $\mathfrak{sl}_2(\wedge)$  in Proposition 7, which implies Theorem 1.

### 5. Basic properties of SKh as an $\mathfrak{sl}_2$ representation

The fact that the sutured Khovanov homology of an annular link is an  $\mathfrak{sl}_2$  representation has the following immediate consequence.

**COROLLARY 1.** *Let  $\mathbb{L} \subset A \times I$  be an annular link. Then*

$$\dim_{\mathbb{C}}(\mathrm{SKh}(\mathbb{L}; k)) \geq \dim_{\mathbb{C}}(\mathrm{SKh}(\mathbb{L}; k'))$$

*whenever  $k \equiv k' \pmod{2}$  and  $|k| \leq |k'|$ .*

*Proof.* The  $\mathfrak{sl}_2$  action of Proposition 3 on  $\mathrm{SKh}(\mathbb{L})$  has the property that the  $\mathfrak{sl}_2$  weight space grading on  $\mathrm{SKh}(\mathbb{L})$  agrees with the  $k$  (filtration) grading. The statement of the corollary is therefore just a restatement of the inequalities that hold between weight space dimensions of arbitrary finite-dimensional  $\mathfrak{sl}_2$  representations.  $\square$

The above corollary says that the dimensions of the  $k$ -graded components of  $\mathrm{SKh}(\mathbb{L})$  are a *trapezoidal* sequence of positive integers.

Moreover, the  $\mathfrak{sl}_2$  representation structure on the sutured Khovanov homology of an annular link gives an alternative way to understand its symmetry (Lemma 2) with respect to the  $k$  grading. Indeed, the following lemma is readily seen from the chain-level definitions of the raising operator  $e$ , the lowering operator  $f$ , and the involution  $\Theta$  on the sutured chain complex associated to an annular link.

**LEMMA 5.** *Let  $\mathbb{L} \subset A \times I$  be an annular link and let  $e, f, \Theta$  be the endomorphisms on  $\mathrm{SKh}(\mathbb{L})$  described above. Then  $e = \Theta f \Theta$ .*

#### 5.1 Functoriality for annular link cobordisms

The  $\mathfrak{sl}_2$  representation structure is functorial with respect to annular link cobordisms. To state this precisely, we must first introduce the following closely related topological categories.

**DEFINITION 3.** Let  $\mathrm{Cob}_{/i}^4(A)$  denote the category of *annular link cobordisms*. The objects of  $\mathrm{Cob}_{/i}^4(A)$  are oriented annular links in general position (i.e., the projection to  $A \times \{1/2\}$  is a diagram). A morphism between links  $\mathbb{L}_0$  and  $\mathbb{L}_1$  is a smoothly embedded oriented surface,  $F \subset (A \times I) \times I$ , satisfying  $\partial F = -(\mathbb{L}_0 \times \{0\}) \amalg (\mathbb{L}_1 \times \{1\})$ , considered modulo isotopy rel boundary.

DEFINITION 4. Let  $Comb^4(A)$  denote the category of *combinatorial* annular link cobordisms. The objects of  $Comb^4(A)$  are annular link diagrams, considered up to planar isotopy. The morphisms are Carter–Saito movies [CS93], specified by finite sequences of link diagrams, each related to the next by a Reidemeister move, an elementary Morse move, or a planar isotopy in  $A$ .

We have a canonical functor  $\mathcal{L}: Comb^4(A) \rightarrow Cob_{/i}^4(A)$  obtained by lifting each annular link diagram to a specific annular link in general position and each Carter–Saito movie to a specific annular link cobordism with Morse decomposition described by the movie. The following is an annular version of [Bar05, Theorem 4].

PROPOSITION 4. *The assignment  $\mathcal{P}(\mathbb{L}) \mapsto [\mathcal{P}(\mathbb{L})]$  extends to a functor*

$$[-] : Comb^4(A) \longrightarrow Kob_{/h}(A).$$

*Up to signs, this functor factors through the category  $Cob_{/i}^4(A)$  via the canonical functor  $\mathcal{L}: Comb^4(A) \rightarrow Cob_{/i}^4(A)$ . In particular,  $[-]$  descends to a functor  $Cob_{/i}^4(A) \rightarrow Kob_{/\pm h}(A)$ .*

*Proof.* On generating morphisms of  $Comb^4(A)$ , we define the functor  $[-]$  as follows.

- To movies representing Reidemeister moves, we assign the homotopy equivalences constructed in [Bar05] within the proof of the invariance theorem (see [Bar05, Theorem 1]).
- To movies representing elementary Morse cobordisms, we assign the chain maps obtained by interpreting these Morse cobordisms as the corresponding generating morphisms of  $Cob_{/\ell}^3(A)$ .
- For movies representing planar isotopies in  $A$ , we use an analogous definition.

In the Appendix, we adapt the Carter–Saito theorem [CS93] to the annular setting. That is, we show that every (smooth) annular link cobordism can be presented by an annular Carter–Saito movie, and that two annular Carter–Saito movies represent isotopic annular link cobordisms if and only if they can be transformed one to the other by a finite sequence of annular Carter–Saito movie moves. Bar-Natan already proved [Bar05] that the chain maps associated to Carter–Saito movies are invariant under movie moves when considered up to sign and homotopy<sup>5</sup> and so it follows that the functor  $[-]$  descends to a functor  $Cob_{/i}^4(A) \rightarrow Kob_{/\pm h}(A)$ , as desired.  $\square$

### 5.2 The $\mathfrak{sl}_2$ action via marked points

Let  $\mathcal{P}(\mathbb{L}) \subset S^2 - \mathbb{O} - \mathbb{X}$  be a diagram of a link  $\mathbb{L} \subset A \times I \subset S^3$  and suppose that  $p_1, \dots, p_n \subset \mathcal{P}(\mathbb{L})$  is a collection of  $n$  distinct marked points on  $\mathcal{P}(\mathbb{L})$  in the complement of a neighborhood of the crossings. Temporarily forgetting the data of the base point  $\mathbb{X}$ , recall [Kho00, Kho03, HN13] that we have an action of

$$\mathcal{A}_n := \mathbb{C}[x_1, \dots, x_n]/(x_1^2, \dots, x_n^2)$$

on the chain complex  $CKh(\mathcal{P}(\mathbb{L}))$  defined as follows.

Let  $\mathcal{P}'(\mathbb{L})$  denote the diagram obtained from  $\mathcal{P}(\mathbb{L})$  by placing, for each  $i \in \{1, \dots, n\}$ , a tiny trivial circle  $C_i$  in a region adjacent to  $p_i$ . We then have

$$CKh(\mathcal{P}'(\mathbb{L})) \cong CKh(\mathcal{P}(\mathbb{L})) \otimes \mathcal{A}_n$$

along with a map

$$m : CKh(\mathcal{P}(\mathbb{L})) \otimes \mathcal{A}_n \rightarrow CKh(\mathcal{P}'(\mathbb{L}))$$

---

<sup>5</sup> The up-to-sign functoriality can be fixed by working with an appropriate model of Khovanov homology, e.g., [CMW09].



realized as the composition of the  $n$  (commuting) multiplication maps associated to merging  $\mathcal{P}(\mathbb{L})$  with  $C_1, \dots, C_n$  at  $p_1, \dots, p_n$ .

PROPOSITION 5. Suppose that  $\mathbb{L} \subset A \times I \subset S^3$  is an annular link with diagram  $\mathcal{P}(\mathbb{L}) \subset S^2 - \mathbb{O} - \mathbb{X} \subset S^2 - \mathbb{O}$ . Let  $\gamma$  be any arc from  $\mathbb{X}$  to  $\mathbb{O}$  that misses all crossings of  $\mathcal{P}(\mathbb{L})$  and intersects  $\mathcal{P}(\mathbb{L})$  transversely in  $n$  points  $p_1, \dots, p_n$  (whose ordering is determined by the orientation of  $\gamma$ ). Consider the action of  $\mathcal{A}_n := \mathbb{C}[x_1, \dots, x_n]/(x_1^2, \dots, x_n^2)$  on  $\text{CKh}(\mathcal{P}(\mathbb{L}))$  induced by the marked points  $p_1, \dots, p_n$ .

- (1) Let  $f : \text{CKh}(\mathcal{P}(\mathbb{L})) \rightarrow \text{CKh}(\mathcal{P}(\mathbb{L}))$  be the lowering operator of the  $\mathfrak{sl}_2$  action described in § 4.2. Then

$$f = \sum_{i=1}^n (-1)^{i-1} x_i.$$

- (2) Let  $e : \text{CKh}(\mathcal{P}(\mathbb{L})) \rightarrow \text{CKh}(\mathcal{P}(\mathbb{L}))$  be the raising operator of the  $\mathfrak{sl}_2$  action described in § 4.2. Then

$$e = \Theta \left( \sum_{i=1}^n (-1)^{i-1} x_i \right) \Theta,$$

where  $\Theta$  is the involution described in Lemma 2.

*Proof.* We verify statement (1) by showing that the chain-level map  $\sum_{i=1}^n (-1)^{i-1} x_i$  corresponding to any arc  $\gamma$  from  $\mathbb{X}$  to  $\mathbb{O}$  agrees with the chain-level map  $f$  described in § 4.2.

To see this, let  $\mathcal{P}_{\mathcal{I}}(\mathbb{L})$  be a resolution of  $\mathcal{P}(\mathbb{L})$ . Recall from § 4.2 that the action of the lowering operator  $f$  on the vector space associated to  $\mathcal{P}_{\mathcal{I}}(\mathbb{L})$  is the standard tensor product representation of the actions of  $f$  on the vector spaces associated to each circle of the resolution considered separately.

Now suppose that  $C$  is a non-trivial circle of  $\mathcal{P}_{\mathcal{I}}(\mathbb{L})$ . Any arc  $\gamma$  as above will then intersect  $C$  in an odd number of points  $p_{i_1}, \dots, p_{i_k}$  according to their order of intersection with the oriented arc  $\gamma$ . As the actions of  $x_{i_1}, \dots, x_{i_k}$  on the vector space associated to  $\mathcal{P}_{\mathcal{I}}(\mathbb{L})$  all agree, we then have

$$\sum_{j=1}^k (-1)^{i_j-1} x_{i_j} = (-1)^{i_1-1} x_{i_1}.$$

Since  $i_1$  differs, mod 2, from the number of non-trivial circles separating  $C$  from  $\mathbb{X}$  (i.e., using the terminology of § 4.2, we have  $i_1 - 1 \equiv \epsilon(C) \pmod{2}$ ), the above agrees with the action of  $f$  on the vector space associated to  $C$  described in § 4.2. Similarly, if  $C$  is a trivial circle of  $\mathcal{P}_{\mathcal{I}}(\mathbb{L})$ , any arc  $\gamma$  will intersect  $C$  in an even number of points  $p_{i_1}, \dots, p_{i_k}$ , so the action of  $\sum_{j=1}^k (-1)^{i_j-1} x_{i_j}$  on  $C$  is 0, agreeing with the action from § 4.2. This concludes the proof of statement (1), and statement (2) now follows from Lemma 5. □

*Remark 5.* The reader is warned that although the chain-level maps  $x_i$  commute with the ordinary Khovanov differential  $\partial$ , they do not commute with the sutured Khovanov differential  $\partial_0$ . On the other hand, their alternating sum commutes with  $\partial_0$ , as does the involution  $\Theta$ , but  $\Theta$  does not commute with  $\partial$ . See Lemma 3.

*Remark 6.* Recall that it is shown in [HN13, Proposition 2.2] that the chain-level action of  $\mathcal{A}_n$  described above induces a well-defined action (modulo signs) of

$$\mathcal{A}_\ell := \mathbb{C}[X_1, \dots, X_\ell]/(X_1^2, \dots, X_\ell^2)$$

on the ordinary Khovanov homology of an  $\ell$ -component link (one need only ensure that each link component contains at least one marked point). In particular,  $X_i$  denotes the map induced on the ordinary Khovanov homology of  $\mathbb{L}$  by (any one of) the base point(s) marking the  $i$ th component of  $\mathbb{L}$ .

Recalling that there is a spectral sequence relating  $\text{SKh}(\mathbb{L} \subset A \times I)$  to  $\text{Kh}(\mathbb{L} \subset S^3)$ , it is tempting to conclude that the map induced by the lowering operator  $f$  on  $\text{Kh}(\mathbb{L})$  agrees with  $g = \sum_{i=1}^n \epsilon_i X_i$  for some choices  $\epsilon_i \in \{\pm 1\}$ .

However, the  $E^\infty$  page of the spectral sequence is the associated graded  $\text{grKh}(\mathbb{L})$  of  $\text{Kh}(\mathbb{L})$  with respect to the induced filtration. As a result, we can only conclude the weaker statement that the highest-degree terms of the maps agree. More precisely, noting that  $f$  is a filtered map of degree  $-2$  on the filtered complex described in Remark 1, we can regard  $f$  as a filtration-preserving map

$$f : \text{CKh}(\mathbb{L}) \rightarrow \text{CKh}(\mathbb{L})\{\{2\}\},$$

where in the above  $\{\{n\}\}$  is the operator that shifts  $k$  gradings (and hence the induced filtration) up by 2. Let  $f_\infty$  denote the map induced by  $f$  on the  $E^\infty$  page of the spectral sequence associated to the  $k$  filtration, and decompose  $g = g_{-2} + g_{-4} + \dots$  into its  $k$ -homogeneous terms with respect to the induced  $k$  grading on the  $E^\infty$  page. Then

$$f_\infty = g_{-2}.$$

### 6. SKh and the current algebra $\mathfrak{sl}_2(\wedge)$

In this section we extend the action of  $\mathfrak{sl}_2$  on  $\text{SKh}(\mathbb{L})$  to an action of the exterior current algebra,  $\mathfrak{sl}_2(\wedge)$ . Note that, in contrast to the  $\mathfrak{sl}_2$  action, the  $\mathfrak{sl}_2(\wedge)$  relations hold at the chain level *only up to homotopy*. In what follows, we will construct an action of a slightly larger Lie superalgebra,  $\mathfrak{sl}_2(\wedge)_{dg}$ , on the sutured annular chain complex and then show that it induces an action of  $\mathfrak{sl}_2(\wedge)$  on the homology. To make these statements precise, we first review some algebra.

#### 6.1 Chain complexes and Lie superalgebras

Let  $(C^\bullet, \partial)$  be a  $\mathbb{Z}$ -graded chain complex. The  $\mathbb{Z}$  grading  $C^\bullet = \bigoplus_{i \in \mathbb{Z}} C^i$  induces a  $\mathbb{Z}_2$  grading

$$C = C^{\text{even}} \oplus C^{\text{odd}},$$

where

$$C^{\text{even}} = \bigoplus_{n \in \mathbb{Z}} C^{2n} \quad \text{and} \quad C^{\text{odd}} = \bigoplus_{n \in \mathbb{Z}} C^{2n+1}$$

and hence the structure of a super vector space. In fact, as we now explain,  $C^\bullet$  is naturally a representation of its endomorphism space, which itself may be regarded as a Lie superalgebra.

Let  $\text{End}(C^\bullet)$  denote the hom complex of  $C^\bullet$ , which is a  $\mathbb{Z}$ -graded super vector space in its own right:

$$\text{End}(C^\bullet) = \bigoplus_{n \in \mathbb{Z}} \text{End}^n(C^\bullet),$$

$$\text{End}^n(C^\bullet) = \{f : C^\bullet \rightarrow C^{\bullet+n}\}.$$

Elements of  $\text{End}^n(C^\bullet)$  are linear maps of homological degree  $n$ , and are not required to intertwine the differential  $\partial$ . In fact the differential  $\partial \in \text{End}(C^\bullet)$  is itself a degree-one endomorphism of  $C^\bullet$ .

We endow  $\text{End}(C^\bullet)$  with the structure of a Lie superalgebra by declaring, for  $f \in \text{End}^n(C^\bullet)$  and  $g \in \text{End}^m(C^\bullet)$ ,

$$[f, g] = fg - (-1)^{nm}gf.$$

The superalgebra  $\text{End}(C^\bullet)$  is also a chain complex, with differential

$$\mathcal{D} : \text{End}(C^\bullet) \longrightarrow \text{End}(C^{\bullet+1}), \quad \mathcal{D}(f) = [\partial, f].$$

Let  $H(\text{End}(C^\bullet))$  be the homology of  $\text{End}(C^\bullet)$ . Then there is a canonical morphism of Lie superalgebras

$$H(\text{End}(C^\bullet)) \longrightarrow \text{End}(H(C^\bullet)).$$

Explicitly, if  $\theta \in \text{End}(C^\bullet)$  and  $x \in C^\bullet$  are cycles representing homology classes  $[\theta]$  and  $[x]$ , respectively, then one makes the well-defined assignment

$$[\theta]([x]) := [\theta(x)].$$

Note that the cycles in  $(\text{End}^n(C^\bullet), \mathcal{D})$  are precisely the chain maps (or skew-chain maps, depending on the parity of  $n$ ):<sup>6</sup>

$$C^\bullet \rightarrow C^\bullet[n],$$

and the boundaries are precisely those chain maps that are chain homotopic to 0. Informally, one views the image of  $H(\text{End}(C^\bullet))$  under the canonical morphism above as the collection of (graded) chain maps on  $C^\bullet$ , modulo homotopy.

### 6.2 The Lie superalgebra $\mathfrak{sl}_2(\wedge)_{dg}$

We now describe a  $\mathbb{Z}$ -graded Lie superalgebra  $\mathfrak{sl}_2(\wedge)_{dg}$  that is closely related (cf. Lemma 7) to the Lie superalgebra  $\mathfrak{sl}_2(\wedge)$  defined in § 2.2.

The underlying  $\mathbb{Z}$ -graded super vector space of  $\mathfrak{sl}_2(\wedge)_{dg}$  is generated (as a Lie superalgebra) by  $\{e, f, h, v_2, v_{-2}, d, D\}$ , with the generators  $\{e, f, h\}$  in degree 0 and  $\{v_2, v_{-2}, d, D\}$  in degree 1. The  $\mathbb{Z}_2$  grading on  $\mathfrak{sl}_2(\wedge)$  is induced from the  $\mathbb{Z}$  grading, and the defining super commutation relations are as follows:

- $[e, f] = h$ ;
- $[h, e] = 2e$ ;
- $[h, f] = -2f$ ;
- $[e, v_2] = 0$ ;
- $[e, v_{-2}] = -[f, v_2]$ ;
- $[f, v_{-2}] = 0$ ;
- $[h, v_2] = 2v_2$ ;
- $[h, v_{-2}] = -2v_{-2}$ ;
- $[d, y] = 0$  for all  $y \in \{e, f, h, v_2, v_{-2}\}$ ;
- $[D, y] = 0$  for all  $y \in \{e, f, h, v_2, v_{-2}\}$ ;
- $[d, d] = [D, D] = [v_2, v_2] = [v_{-2}, v_{-2}] = 0$ ;
- $[v_2, v_{-2}] + [d, D] = 0$ .

Let  $\tilde{v}_0 = [e, v_{-2}]x = [v_2, v_{-2}]$ . One may check using the above relations and the super Jacobi identity that  $\tilde{v}_0 = -[f, v_2]$  and that  $x = -[d, D] = \frac{1}{2}[\tilde{v}_0, \tilde{v}_0]$ . Then we have the following.

LEMMA 6. *The set  $\{e, f, h, v_2, v_{-2}, \tilde{v}_0, d, D, x\}$  is a basis of  $\mathfrak{sl}_2(\wedge)_{dg}$ .*

---

<sup>6</sup> Here ‘ $[n]$ ’ is the height shift operator on a chain complex:  $C[n]^\bullet := C^{\bullet-n}$ .

*Proof.* A straightforward computation shows that the degree-2 subspace of  $\mathfrak{sl}_2(\wedge)_{dg}$  is at most one dimensional, spanned by  $[v_2, v_{-2}] - [d, D]$ ; from this it follows easily that the set  $\{e, f, h, v_2, v_{-2}, \tilde{v}_0, d, D, x\}$  spans  $\mathfrak{sl}_2(\wedge)_{dg}$ . The linear independence of this set follows from the representation on the annular chain complex constructed in §4.  $\square$

It is clear from the above description that  $\mathfrak{sl}_2(\wedge)_{dg}$  is closely related to  $\mathfrak{sl}_2(\wedge)$ . Indeed, we may regard  $\mathfrak{sl}_2(\wedge)_{dg}$  as a chain complex by declaring the adjoint action of  $d$  to be the differential, as described in the previous subsection. We have the following.

LEMMA 7. *The homology of  $\mathfrak{sl}_2(\wedge)_{dg}$  taken with respect to the differential  $[d, \cdot]$  is isomorphic to the direct sum of  $\mathfrak{sl}_2(\wedge)$  and the trivial Lie super algebra:*

$$H(\mathfrak{sl}_2(\wedge)_{dg}, [d, \cdot]) \cong \mathfrak{sl}_2(\wedge) \oplus \mathbb{C}.$$

Moreover, if  $(C^\bullet, d)$  is a  $\mathbb{Z}$ -graded  $\mathfrak{sl}_2(\wedge)_{dg}$  representation, regarded as a chain complex with differential given by the action of  $d$ , then the canonical map

$$H(\mathfrak{sl}_2(\wedge)_{dg}) \rightarrow \text{End}(H(C^\bullet, d))$$

factors through  $\mathfrak{sl}_2(\wedge)$ .

*Proof.* Referring to the bracket relations and Lemma 6, we see that the kernel of  $[d, \cdot]$  is spanned by  $\{e, f, h, v_2, \tilde{v}_0, v_{-2}, d, x\}$ , while the image is spanned by  $x$ . The obvious map  $H(\mathfrak{sl}_2(\wedge)_{dg}, [d, \cdot]) \rightarrow \mathfrak{sl}_2(\wedge)$  which takes  $e, f, h$  to  $e, f, h$ ,  $v_2, v_{-2}$  to  $v_2, v_{-2}$ ,  $\tilde{v}_0$  to  $v_0$ , and  $d$  to 0 is therefore surjective, with one-dimensional kernel. Moreover, if  $C^\bullet$  is any  $\mathfrak{sl}_2(\wedge)_{dg}$  representation, then  $[d] \in H(\mathfrak{sl}_2(\wedge)_{dg}, [d, \cdot])$  will act trivially on  $H(C^\bullet, d)$ .  $\square$

### 6.3 The current algebra $\mathfrak{sl}_2(\wedge)$ and its action on $\text{SKh}(\mathbb{L})$

We are now ready to extend the action of  $\mathfrak{sl}_2$  on  $\text{CKh}(\mathbb{L})$  to an action of  $\mathfrak{sl}_2(\wedge)_{dg}$  by defining

$$\Phi : \mathfrak{sl}_2(\wedge)_{dg} \longrightarrow \text{End}(\text{CKh}(\mathbb{L}))$$

via:

- $v_2 \mapsto \Phi_+$ ;
- $v_{-2} \mapsto \partial_-$ ;
- $d \mapsto \partial_0$ ;
- $D \mapsto \Phi_0$ .

PROPOSITION 6. *The above assignment defines a homomorphism of Lie superalgebras*

$$\Phi : \mathfrak{sl}_2(\wedge)_{dg} \longrightarrow \text{End}(\text{CKh}(\mathbb{L})).$$

*Proof.* The  $\mathfrak{sl}_2$  relations involving only  $\{e, f, h\}$  were established in the course of proving Proposition 3. The relations involving commutators between pairs of degree-one elements  $\{v_{-2}, v_2, d, D\}$  follow immediately from the relations in Lemma 3.

The mixed relations involving commutators of one of  $\{e, f, h\}$  with one of  $\{v_{-2}, v_2, d, D\}$  follow from a straightforward case-by-case check along the three possible types of edges in the cube of resolutions.

For example, consider the relation  $[e, v_{-2}] = [v_2, f]$  along an edge in which two non-trivial circles merge to form a single trivial circle. Recalling that  $v_{-2}$  is identified with  $\partial_-$  (respectively,  $v_2$  is identified with  $\Phi_+$ ), one computes in this case that

$$\begin{aligned} (*) \otimes (v_- \otimes \bar{v}_-) &\mapsto 0, \\ (*) \otimes (v_+ \otimes \bar{v}_+) &\mapsto 0, \\ (*) \otimes (v_- \otimes \bar{v}_+) &\mapsto -(*) \otimes w_+, \\ (*) \otimes (v_+ \otimes \bar{v}_-) &\mapsto (*) \otimes w_+, \end{aligned}$$

under both the map  $e\partial_- - \partial_-e$  and the map  $\Phi_+f - f\Phi_+$ , where in the above we are denoting by  $(*)$  a fixed marking on the circles in the resolution uninvolved in the merge cobordism.  $\square$

Passing to homology and using Lemma 7, we arrive at the following proposition, which completes the proof of Theorem 1 from the introduction.

PROPOSITION 7. *The homomorphism of Lie superalgebras  $\Phi : \mathfrak{sl}_2(\wedge)_{dg} \rightarrow \text{End}(\text{CKh}(\mathbb{L}))$  induces a homomorphism of Lie superalgebras*

$$\Psi : \mathfrak{sl}_2(\wedge) \rightarrow \text{End}(\text{SKh}(\mathbb{L})).$$

*This action of  $\mathfrak{sl}_2(\wedge)$  is functorial for annular link cobordisms.*

Before proving this proposition, we prove a useful lemma involving the involution  $\Theta$  defined in Lemma 2.

LEMMA 8. *Let  $\mathcal{P}(\mathbb{L}), \mathcal{P}(\mathbb{L}')$  be annular link diagrams whose underlying links are connected by an annular link cobordism  $F$ , let*

$$m_0 : \text{CKh}(\mathbb{L}, \partial_0) \rightarrow \text{CKh}(\mathbb{L}', \partial_0)$$

*be the chain map induced on the annular Khovanov chain complex by any decomposition of  $F$  into elementary cobordisms and Reidemeister moves, and let  $\Theta$  be the involution on  $\mathcal{P}(\mathbb{L}), \mathcal{P}(\mathbb{L}')$  defined in Lemma 2. Then we have  $\Theta m_0 = m_0 \Theta$ .*

*Proof.* We need only show that  $\Theta$  commutes with the  $k$ -grading-preserving part of the map on the Khovanov complex associated to each:

- elementary annular cobordism of index 0, 1, or 2; and
- Reidemeister move.

The fact that  $\Theta$  commutes with the annular chain map induced by an elementary annular saddle (index-1) cobordism follows from Lemma 3, part (3), noting that (up to a grading shift) the  $k$ -grading-preserving part of the Khovanov map induced by an annular cobordism agrees with the annular differential on crossing-less link diagrams.

The fact that  $\Theta$  commutes with the annular chain map associated to an annular index-0 (cup) or index-2 (cap) cobordism is immediate from the definition of  $\Theta$  and the fact that an annular cup (respectively, cap) cobordism introduces (respectively, deletes) a *trivial* circle.

Now the fact that  $\Theta$  commutes with the maps induced by annular Reidemeister moves follows from the observation that each of these maps can be expressed as a composition of linear combinations of the maps described above (cf. [Bar05, § 4.3]).  $\square$

*Proof of Proposition 7.* Since the generator  $d$  of  $\mathfrak{sl}_2(\wedge)_{dg}$  is sent to the annular differential  $\partial_0$ , the homology of  $\mathfrak{sl}_2(\wedge)_{dg}$  taken with respect to  $d$  acts on  $\text{SKh}(\mathbb{L})$ . By Lemma 7, the action of this homology factors through the current algebra  $\mathfrak{sl}_2(\wedge)$ .

What remains is to show that any annular link cobordism commutes (up to homotopy) with the operators  $v_2, v_{-2}$ . To see this, let  $m$  be the chain map induced on the ordinary Khovanov chain complex by an annular link cobordism. Write  $m = m_0 + m_-$ , where  $m_0$  preserves the annular  $k$  grading and  $m_-$  is a linear combination of components of negative  $k$  degree. The claim is that  $m_0$  and  $v_{-2}(= \partial_-)$  commute up to homotopy. Since  $m$  is a chain map, Khovanov’s differential  $\partial = \partial_0 + \partial_-$  commutes with  $m$  and it follows that

$$m_0\partial_- - \partial_-m_0 + m_-\partial_0 - \partial_0m_- = 0.$$

Thus,  $m_-$  provides a homotopy between  $[m_0, \partial_-]$  and 0, as desired. The analogous statement for  $v_2$  follows from the above, combined with the observations that  $\Phi_+ = \Theta\partial_-\Theta$  (Lemma 3) and that  $\Theta$  commutes with  $m_0$  (Lemma 8). □

*Remark 7.* A curious point to note in the proof of Proposition 7 is that most of the proof works equally well if we use the annular Lee deformation  $\Phi_0$  in place of the usual annular differential  $\partial_0$ : the commutation relations that held on the nose at the chain level still hold, and the differential/homotopy roles of  $\partial_0$  and  $\Phi_0$  are simply exchanged. (This is the symmetry between  $d$  and  $D$  in  $\mathfrak{sl}_2(\wedge)_{dg}$ .) Indeed, one quickly checks that Lemma 7 holds equally well with ‘ $D$ ’ replacing ‘ $d$ ’ everywhere in the statement and the proof. Thus, the current algebra  $\mathfrak{sl}_2(\wedge)$  also acts on the homology of  $\text{CKh}(\mathcal{P}(\mathbb{L}))$  taken with respect to the differential  $\Phi_0$ . On the other hand, the homology with respect to  $\Phi_0$  is neither functorial for annular link cobordisms nor is it an annular link invariant.

The observant reader may now wonder whether the  $\mathfrak{sl}_2(\wedge)_{dg}$  action on the sutured annular chain complex  $\text{CKh}(\mathbb{L})$  gives rise to any interesting new actions on Khovanov or Lee homology. Sadly, the answer is no, as we see in Lemmas 9 and 10. In what follows, let  $\mathcal{L}$  denote the two-dimensional abelian Lie superalgebra with a single degree-0 generator,  $y_0$ , and a single degree-1 generator,  $y_1$ .

LEMMA 9. *The homology  $H(\mathfrak{sl}_2(\wedge)_{dg}, [d + v_{-2}, \cdot])$  has a codimension-one direct summand isomorphic to  $\mathcal{L}$ . Moreover, if  $(C^\bullet, d + v_{-2})$  is any  $\mathbb{Z}$ -graded  $\mathfrak{sl}_2(\wedge)_{dg}$  representation, regarded as a chain complex with differential  $d + v_{-2}$ , then the canonical map*

$$H(\mathfrak{sl}_2(\wedge)_{dg}) \rightarrow \text{End}(H(C^\bullet, d + v_{-2}))$$

*factors through  $\mathcal{L}$ .*

*Proof.* The set  $\{[f], [v_2 + D], [d]\}$  is a basis for  $H(\mathfrak{sl}_2(\wedge)_{dg}, [d + v_{-2}, \cdot])$ , and we calculate that all pairwise brackets are nullhomologous. The map

$$H(\mathfrak{sl}_2(\wedge)_{dg}, [d + v_{-2}, \cdot]) \rightarrow \mathcal{L}$$

sending  $[f] \mapsto y_0, [v_2 + D] \mapsto y_1$ , and  $[d] \mapsto 0$  is a Lie superalgebra homomorphism, and  $[d] = [d + v_{-2}]$  will act trivially on the homology of any  $\mathfrak{sl}_2(\wedge)_{dg}$  representation. □

In particular, the action of  $\mathfrak{sl}_2(\wedge)_{dg}$  on the annular chain complex  $\text{CKh}(\mathbb{L})$  induces two commuting endomorphisms of  $\text{Kh}(\mathbb{L})$ , one of which can be described in terms of the standard action by base points on Khovanov homology (compare § 5.2) and the other of which can be described in terms of the Lee deformation.

LEMMA 10. *The homology  $H(\mathfrak{sl}_2(\wedge)_{dg}, [d + v_{-2} + D + v_2, \cdot])$  has a codimension-one direct summand isomorphic to  $\mathcal{L}$ . Moreover, if  $(C^\bullet, d + v_{-2} + D + v_2)$  is any  $\mathbb{Z}$ -graded  $\mathfrak{sl}_2(\wedge)_{dg}$  representation, regarded as a chain complex with differential  $d + v_{-2} + D + v_2$ , then the canonical map*

$$H(\mathfrak{sl}_2(\wedge)_{dg}) \rightarrow \text{End}(H(C^\bullet, d + v_{-2} + D + v_2))$$

*factors through  $\mathcal{L}$ .*

*Proof.* The proof is similar to that of Lemma 9. In this case, the set  $\{[e + f], [d + v_{-2}], [d + v_{-2} + D + v_2]\}$  is a basis for the homology.  $\square$

Thus, the action of  $\mathfrak{sl}_2(\wedge)_{dg}$  on the annular chain complex  $\text{CKh}(\mathbb{L})$  induces two commuting endomorphisms of the Lee homology of  $\mathbb{L}$ . It is straightforward to verify (e.g., by using the canonical generators described in [Ras10, §2.4]) that each Lee homology class associated to an orientation of  $\mathbb{L}$  is an eigenvector for the endomorphism represented by  $[e + f]$ . The endomorphism represented by  $[d + v_{-2}]$  increases homological grading by 1 and hence must act trivially, since Lee homology is supported in even homological gradings [Lee05, Proposition 4.3].

### 7. The symmetric group and the homology of cables

In this section we explore the further symmetry exhibited by the sutured annular Khovanov homology of a cable.

In what follows, let  $\text{TL}_n(1)$  denote the endomorphism algebra<sup>7</sup> of the  $n$ th tensor product of the defining  $\mathfrak{sl}_2$  representation:

$$\text{TL}_n(1) := \text{End}_{U(\mathfrak{sl}_2)}(V^{\otimes n}).$$

The standard presentation of  $\text{TL}_n(1)$  has generators  $\{e_i\}_{i=1}^{n-1}$  and relations

$$e_i^2 = -2e_i, \quad e_i e_j = e_j e_i \quad \text{for } i \neq j \pm 1, \quad e_i e_{i \pm 1} e_i = e_i.$$

In the well-known tangle presentation of  $\text{TL}_n(1)$ , the generator  $e_i$  is drawn as the tangle  $E_i$  of Figure 2. The main goal of this section is to establish the following theorem.

**THEOREM 2.** *Let  $K \subset S^3$  be a knot and let  $\mathbb{L} = K_{n,nm} \subset A \times I$  denote its  $m$ -framed  $n$ -cable. Then there is an action of the symmetric group  $\mathfrak{S}_n$  on the sutured annular Khovanov homology,  $\text{SKh}(\mathbb{L})$ . This  $\mathfrak{S}_n$  action enjoys the following properties:*

- (1) *it commutes with the  $\mathfrak{sl}_2(\wedge)$  action;*
- (2) *it preserves the  $(i, j', k)$  tri-grading on  $\text{SKh}(\mathbb{L})$ ;*
- (3) *it is natural with respect to smooth annular framed link cobordisms;*
- (4) *it factors through the Temperley–Lieb algebra  $\text{TL}_n(1)$ .*

Since the  $\mathfrak{S}_n$  action will be defined using annular link cobordisms, the fact that such an action commutes with the  $\mathfrak{sl}_2(\wedge)$  action and preserves the tri-grading is immediate. Thus, the rest of this section will be devoted to establishing the last two claims.

<sup>7</sup>The notation emphasizes that we are taking the  $q = 1$  specialization of  $\text{TL}_n(q)$ , the endomorphism algebra of the  $n$ th tensor product of the defining  $U_q(\mathfrak{sl}_2)$  module.

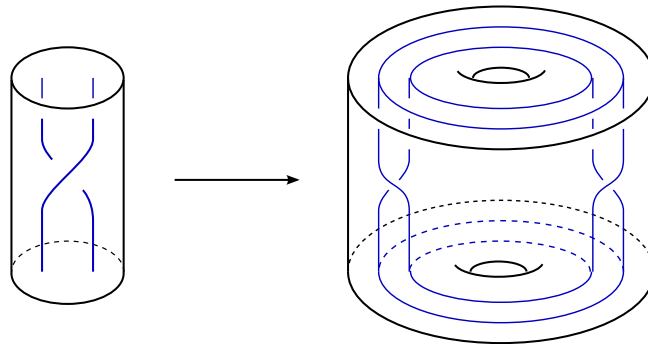

FIGURE 1. Schematic depiction of a tangle  $T \subset D^2 \times I$  (left) and the associated surface of revolution  $S^1 \times T \subset S^1 \times D^2 \times I$  (right). The cobordism  $K^T: K^n \rightarrow K^n$  is obtained from  $S^1 \times T$  by applying the embedding  $\bar{\iota}: S^1 \times D^2 \times I \rightarrow A \times I \times I$ .

### 7.1 Cobordism maps associated to tangles

Let  $K$  be a smooth framed oriented knot in  $A \times I$  and

$$\iota: S^1 \times D^2 \longrightarrow A \times I$$

an embedding which sends the circles  $S^1 \times \{0\}$  and  $S^1 \times \{1\}$  respectively to  $K$  and to a longitude of  $K$  specifying the framing, where  $D^2$  is the closed unit disk in  $\mathbb{C}$  and  $S^1 := \partial D^2$ . Moreover, let  $P_n \subset \text{int}(D^2)$  be a collection of  $n$  evenly spaced points on the real axis. In this situation, the  $n$ -cable of  $K$  can be defined as follows.

DEFINITION 5. The  $n$ -cable of  $K$  is the  $n$ -component link  $K^n := \iota(S^1 \times P_n)$ .

Now suppose that  $T$  is a smooth  $(n, n)$  tangle, i.e., a smooth properly embedded 1-manifold  $T \subset D^2 \times I$  such that  $\partial T = P_n \times \partial I$ . To  $T$ , we can associate the ‘surface of revolution’  $S^1 \times T \subset S^1 \times D^2 \times I$ .

DEFINITION 6. The  $T$ -cable cobordism of  $K$  is the link cobordism  $K^T: K^n \rightarrow K^n$  defined by  $K^T := \bar{\iota}(S^1 \times T)$ , where  $\bar{\iota}: S^1 \times D^2 \times I \rightarrow A \times I \times I$  denotes the embedding given by  $\bar{\iota}(\theta, z, t) := (\iota(\theta, z), t)$  (see Figure 1).

Remark 8. If  $T$  represents the elementary braid group generator  $\sigma_i$ , then  $K^T$  can alternatively be described as the link cobordism traced out by an isotopy of  $K^n$  which exchanges the  $i$ th and the  $(i+1)$ st strands of  $K^n$  by moving these two strands around each other. Explicitly, this isotopy can be defined by  $K_t^n = \iota(S^1 \times P_{n,t})$ , where  $P_{n,t}$  is an isotopy of  $P_n$  which exchanges the  $i$ th and the  $(i+1)$ st points of  $P_n$  by moving these two points around each other in a counterclockwise motion. (Similarly,  $\sigma_i^{-1}$  would be obtained by a clockwise exchange.)

Since the formal Khovanov bracket of annular links is functorial with respect to smooth annular link cobordisms (by Proposition 4), the  $T$ -cable cobordism of  $K$  induces a chain map

$$[K^T]: [K^n] \longrightarrow [K^n],$$

which is well defined up to sign and homotopy. Likewise,  $K^T$  induces maps

$$\phi_{K^T}: \text{SKh}(K^n) \longrightarrow \text{SKh}(K^n) \quad \text{and} \quad \phi'_{K^T}: \text{Kh}'(K^n) \longrightarrow \text{Kh}'(K^n),$$

where  $\text{Kh}'(K^n)$  denotes the Lee homology of  $K^n$  (viewed as a link in  $\mathbb{R}^3$ ). Note that the latter maps are well defined up to sign.





FIGURE 2. The tangles  $E_i$  (left) and  $\Sigma_i$  (right).

### 7.2 Fixing the sign ambiguity

In the following, let  $E_i$ ,  $\Sigma_i$ , and  $\Sigma_i^{-1}$  denote  $(n, n)$  tangles which represent respectively the generator  $e_i$  of the Temperley–Lieb algebra  $\text{TL}_n(a)$ , the generator  $\sigma_i$  of the braid group  $\mathfrak{B}_n$ , and the inverse of the generator  $\sigma_i \in \mathfrak{B}_n$  (see Figure 2).

The goal of this subsection is to pin down the sign in the definition of the maps  $[K^T]$ ,  $\phi_{K^T}$ , and  $\phi'_{K^T}$  for the case where  $T$  is one of the above tangles. We will need the following theorem, due to Rasmussen.

**THEOREM 3** (Rasmussen [Ras05, Proposition 3.2]). *The Lee homology group  $\text{Kh}'(L)$  has a canonical basis whose vectors correspond bijectively to possible orientations on  $L$ . Furthermore, if  $S: L \rightarrow L'$  is a smooth link cobordism with no closed components, then the matrix entries of  $S$  relative to the canonical bases of  $\text{Kh}'(L)$  and  $\text{Kh}'(L')$  satisfy*

$$(\phi'_S)_{o'o} = 2^{-\chi(S)} \begin{cases} \epsilon_{o'o} & \text{if } o \cup o' \text{ extends over } S, \\ 0 & \text{else} \end{cases}$$

for any two orientations  $o$  and  $o'$  on  $L$  and  $L'$ , where  $\epsilon_{o'o} \in \{\pm 1\}$ .

*Remark 9.* The canonical basis vectors referred to in this theorem are rescaled versions of the basis vectors introduced by Lee in [Lee05] and used by Rasmussen in [Ras10].

The above theorem implies that if  $T = \Sigma_i$  or  $T = \Sigma_i^{-1}$ , then

$$(\phi'_{K^T})_{o_p o_p} \in \{\pm 1\},$$

where  $o_p$  denotes the parallel orientation of  $K^n$ , i.e., the orientation for which all strands of  $K^n$  are oriented parallel to the orientation of  $K$ . Likewise, the theorem implies that if  $K = E_i$ , then

$$(\phi'_{K^T})_{o_a o_a} \in \{\pm 1\},$$

where  $o_a$  denotes the alternating orientation of  $K^n$ , i.e., the orientation for which the strands of  $K^n$  are alternatingly oriented parallel and antiparallel to  $K$ , in such a way that the left-most strand of  $K^n$  (corresponding to the left-most point of  $P_n \subset \text{int}(D^2) \cap \mathbb{R}$ ) is oriented parallel to  $K$ .

Now note that

$$\phi_{K^T} = \mathcal{F}([K^T]) \quad \text{and} \quad \phi'_{K^T} = \mathcal{F}'([K^T]),$$

where  $\mathcal{F}$  is the functor defined in § 4 and  $\mathcal{F}'$  denotes Lee’s TQFT [Ras10]. Since  $\mathcal{F}$  and  $\mathcal{F}'$  are additive functors, it follows that any sign choice for  $[K^T]$  induces corresponding sign choices for  $\phi_{K^T}$  and  $\phi'_{K^T}$ , and we can therefore pin down the sign of  $[K^T]$  (and hence of  $\phi_{K^T}$ ) by imposing the following conventions.

*Convention 1.* For  $T = \Sigma_i$  or  $T = \Sigma_i^{-1}$ , define the sign of  $[K^T]$  to be such that the corresponding map on Lee homology satisfies  $(\phi'_{KT})_{o_p o_p} = +1$ .

*Convention 2.* For  $T = E_i$ , define the sign of  $[K^T]$  to be such that the corresponding map on Lee homology satisfies  $(\phi'_{KT})_{o_a o_a} = -1$ .

*Remark 10.* Note that here we are not using the spectral sequence from Khovanov homology to Lee homology, but only the fact that annular Khovanov homology and Lee homology can be obtained from the annular Khovanov bracket by applying additive functors.

Convention 1 immediately implies the following result.

**PROPOSITION 8.** *The assignments  $\sigma_i \mapsto [K^{\Sigma_i}]$  and  $\sigma_i^{-1} \mapsto [K^{\Sigma_i^{-1}}]$  define a representation  $\rho: \mathfrak{B}_n \rightarrow \text{End}_{\mathcal{C}}([K^n])$  of the braid group  $\mathfrak{B}_n$ , where  $\mathcal{C}$  denotes the bounded homotopy category of Bar-Natan’s cobordism category  $\text{Mat}(\text{Cob}_{\ell}^3(A))$ .*

*Proof.* Since the cobordism maps induced on the formal Khovanov bracket are isotopy invariants when considered up to sign and homotopy, it is clear that the maps  $[K^{\Sigma_i}], [K^{\Sigma_i^{-1}}] \in \text{End}_{\mathcal{C}}([K^n])$  satisfy the braid group relations up to possible signs. In order to determine these signs, it suffices to compute the actions of  $[K^{\Sigma_i}][K^{\Sigma_{i+1}}][K^{\Sigma_i}]$  and  $[K^{\Sigma_{i+1}}][K^{\Sigma_i}][K^{\Sigma_{i+1}}]$  on a single non-zero vector.

Now Rasmussen’s theorem together with Convention 1 implies that

$$(\phi'_{K^{\Sigma_i}})_{o_p o_p} = (\phi'_{K^{\Sigma_i^{-1}}})_{o_p o_p} = \begin{cases} 1, & o = o_p, \\ 0, & o \neq o_p, \end{cases}$$

and so the canonical basis vector associated to the orientation  $o_p$  is an eigenvector for  $\phi'_{K^{\Sigma_i}}$  and for  $\phi'_{K^{\Sigma_i^{-1}}}$  for the eigenvalue 1. Thus, when applied to this vector,  $[K^{\Sigma_i}][K^{\Sigma_{i+1}}][K^{\Sigma_i}]$  and  $[K^{\Sigma_{i+1}}][K^{\Sigma_i}][K^{\Sigma_{i+1}}]$  are equal. Consequently, it follows that the maps  $[K^{\Sigma_i}]$  and  $[K^{\Sigma_i^{-1}}]$  satisfy the braid group relations.  $\square$

### 7.3 Temperley–Lieb algebra relations for cobordism maps

We will now show that the representation  $\rho$  described in Proposition 8 factors through the symmetric group  $\mathfrak{S}_n$ . This will in turn imply that the corresponding braid group action on  $\text{SKh}(K^n)$  (given by  $\sigma_i \mapsto \phi_{K^{\Sigma_i}}$  and  $\sigma_i^{-1} \mapsto \phi_{K^{\Sigma_i^{-1}}}$ ) factors through  $\mathfrak{S}_n$ , and thus the main statement of Theorem 2 will follow.

Specifically, we will prove the following proposition, which holds under the assumption of Conventions 1 and 2, and which shows that  $[K^{\Sigma_i}], [K^{\Sigma_i^{-1}}] = [K^{\Sigma_i}]^{-1}$ , and  $[K^{E_i}]$  satisfy the symmetric group relation  $\sigma_i = \sigma_i^{-1}$  and the Kauffman bracket skein relations  $\sigma_i = a + a^{-1}e_i$  and  $\sigma_i^{-1} = a^{-1} + ae_i$  at  $a = 1$ .

**PROPOSITION 9.** *The endomorphisms  $[K^{\Sigma_i}], [K^{\Sigma_i^{-1}}], [K^{E_i}] \in \text{End}_{\mathcal{C}}([K^n])$  satisfy*

$$[K^{\Sigma_i}] = \text{id}_{[K^n]} + [K^{E_i}] = [K^{\Sigma_i^{-1}}].$$

Instead of proving this proposition directly, we break it into two lemmas.

**LEMMA 11.** *There exist signs  $\epsilon_{ij} \in \{\pm 1\}$ ,  $i = 1, \dots, n - 1$ ,  $j = 1, \dots, 4$ , such that*

$$[K^{\Sigma_i}] = \epsilon_{i1} \text{id}_{[K^n]} + \epsilon_{i2} [K^{E_i}] \quad \text{and} \quad [K^{\Sigma_i^{-1}}] = \epsilon_{i3} \text{id}_{[K^n]} + \epsilon_{i4} [K^{E_i}].$$

LEMMA 12.  $\epsilon_{ij} = +1$  for all  $i, j$ .

The proof of Lemma 11 will be deferred to § 7.4.

*Proof of Lemma 12.* By Lemma 11, we have

$$[K^{\Sigma_i}] = \epsilon_{i1} \text{id}_{[K^n]} + \epsilon_{i2} [K^{E_i}]$$

for  $\epsilon_{i1}, \epsilon_{i2} \in \{\pm 1\}$  and hence the corresponding maps in Lee homology satisfy

$$\phi'_{K^{\Sigma_i}} = \epsilon_{i1} \text{id} + \epsilon_{i2} \phi'_{K^{E_i}}.$$

By considering the matrices of the above maps relative to the basis of Theorem 3 and comparing the diagonal entries corresponding to the parallel orientation  $o_p$ , we thus obtain

$$1 = \epsilon_{i1} + 0$$

and hence  $\epsilon_{i1} = 1$ , where we have used Convention 1 and Theorem 3 to conclude that  $(\phi'_{K^{\Sigma_i}})_{o_p o_p} = 1$  and  $(\phi'_{K^{E_i}})_{o_p o_p} = 0$ . Similarly, by comparing the diagonal entries corresponding to the alternating orientation  $o_a$ , we obtain

$$0 = \epsilon_{i1} - \epsilon_{i2} = 1 - \epsilon_{i2}$$

and hence  $\epsilon_{i2} = 1$ , where we have used Theorem 3 and Convention 2 to conclude that  $(\phi'_{K^{\Sigma_i}})_{o_a o_a} = 0$  and  $(\phi'_{K^{E_i}})_{o_a o_a} = -1$ . The proof of  $\epsilon_{i3} = \epsilon_{i4} = 1$  is analogous.  $\square$

We can now use Proposition 9 to prove the following proposition, which implies that the endomorphisms  $[K^{E_i}]$  satisfy the *Temperley–Lieb algebra relations*:

- (1)  $e_i^2 = -(a^2 + a^{-2})e_i$ ;
- (2)  $e_i e_{i\pm 1} e_i = e_i$ ;
- (3)  $e_i e_j = e_j e_i$  whenever  $|i - j| \geq 2$

at  $a = 1$ .

PROPOSITION 10. *The endomorphisms  $[K^{E_i}] \in \text{End}_{\mathbb{C}}([K^n])$  satisfy:*

- (1)  $[K^{E_i}] \circ [K^{E_i}] = -2[K^{E_i}]$ ;
- (2)  $[K^{E_i}] \circ [K^{E_{i\pm 1}}] \circ [K^{E_i}] = [K^{E_i}]$ ;
- (3)  $[K^{E_i}] \circ [K^{E_j}] = [K^{E_j}] \circ [K^{E_i}]$  whenever  $|i - j| \geq 2$ ,

where all relations hold in  $\text{End}_{\mathbb{C}}([K^n])$ .

*Proof.* (1) By Proposition 9, we have  $[K^{E_i}] = [K^{\Sigma_i}] - \text{id}_{[K^n]}$  and hence

$$[K^{E_i}]^2 = ([K^{\Sigma_i}] - \text{id}_{[K^n]})^2 = 2 \text{id}_{[K^n]} - 2[K^{\Sigma_i}] = -2[K^{E_i}],$$

where in the second equality we have used that  $[K^{\Sigma_i}]$  squares to  $\text{id}_{[K^n]}$  because  $[K^{\Sigma_i}]^{-1} = [K^{\Sigma_i}^{-1}] = [K^{\Sigma_i}]$  by Propositions 8 and 9.

(2) Since the chain maps induced by annular link cobordisms are isotopy invariants when considered up to sign and homotopy and since the tangles  $E_i \circ E_{i\pm 1} \circ E_i$  and  $E_i$  are isotopic, it

is clear that (2) holds up to an overall sign. It is therefore clear that the induced maps in Lee homology satisfy

$$\phi'_{K^{E_i}} \circ \phi'_{K^{E_{i\pm 1}}} \circ \phi'_{K^{E_i}} = \epsilon \phi'_{K^{E_i}}$$

for an  $\epsilon \in \{\pm 1\}$ . To conclude that  $\epsilon = 1$ , we now use Proposition 9 to write the right-hand side of the above equation as

$$\epsilon(\phi'_{K^{\Sigma_i}} - \text{id})$$

and the left-hand side as

$$(\phi'_{K^{\Sigma_i}} - \text{id}) \circ (\phi'_{K^{\Sigma_{i\pm 1}}} - \text{id}) \circ (\phi'_{K^{\Sigma_i}} - \text{id}) = \phi'_{K^{\Sigma_i}} \circ \phi'_{K^{\Sigma_{i\pm 1}}} \circ \phi'_{K^{\Sigma_i}} - 2 \text{id} + \delta,$$

where  $\delta := -\phi'_{K^{\Sigma_i}} \circ \phi'_{K^{\Sigma_{i\pm 1}}} - \phi'_{K^{\Sigma_{i\pm 1}}} \circ \phi'_{K^{\Sigma_i}} + 2\phi'_{K^{\Sigma_i}} + \phi'_{K^{\Sigma_{i\pm 1}}}$ . This yields

$$\phi'_{K^{\Sigma_i}} \circ \phi'_{K^{\Sigma_{i\pm 1}}} \circ \phi'_{K^{\Sigma_i}} - 2 \text{id} + \delta = \epsilon(\phi'_{K^{\Sigma_i}} - \text{id})$$

and, by considering the matrices of the above maps relative to the basis of Theorem 3 and comparing the diagonal entries corresponding to the alternating orientation  $o_a$ , we obtain the equation

$$(\phi'_{K^{\Sigma_i}} \circ \phi'_{K^{\Sigma_{i\pm 1}}} \circ \phi'_{K^{\Sigma_i}} - 2 \text{id} + \delta)_{o_a o_a} = \epsilon(\phi'_{K^{\Sigma_i}} - \text{id})_{o_a o_a}.$$

It is now straightforward to check that the alternating orientation  $o_a$  is compatible with the cobordism  $K^{\Sigma_i} \circ K^{\Sigma_{i\pm 1}} \circ K^{\Sigma_i}$ , but not with the cobordisms  $K^{\Sigma_i} \circ K^{\Sigma_{i\pm 1}}$ ,  $K^{\Sigma_{i\pm 1}} \circ K^{\Sigma_i}$ ,  $K^{\Sigma_i}$ , and  $K^{\Sigma_{i\pm 1}}$ . Indeed, by Remark 8, one can think of these cobordisms in terms of isotopies which permute the strands of  $K^n$ ; and while the permutation corresponding to  $K^{\Sigma_i} \circ K^{\Sigma_{i\pm 1}} \circ K^{\Sigma_i}$  takes the alternating orientation to itself, the permutations corresponding to the other cobordisms do not. By Theorem 3, we thus have

$$(\phi'_{K^{\Sigma_i}} \circ \phi'_{K^{\Sigma_{i\pm 1}}} \circ \phi'_{K^{\Sigma_i}})_{o_a o_a} = \epsilon' \quad \text{and} \quad (\delta)_{o_a o_a} = (\phi'_{K^{\Sigma_i}})_{o_a o_a} = 0$$

for a sign  $\epsilon' \in \{\pm 1\}$  and, inserting these expressions into the above equation, we get

$$\epsilon' - 2 + 0 = \epsilon(0 - 1).$$

However, since  $\epsilon, \epsilon' \in \{\pm 1\}$ , the equation  $\epsilon' - 2 = -\epsilon$  can only hold if  $\epsilon' = \epsilon = 1$ , and hence (2) follows.

(3) Relation (3) follows because  $[K^{E_i}]$  can be written as  $[K^{E_i}] = [K^{\Sigma_i}] - \text{id}_{[K^n]}$  (by Proposition 9) and because the  $[K^{\Sigma_i}]$  satisfy the braid group relations (by Proposition 8).  $\square$

### 7.4 Proof of Lemma 11

In this subsection we will assume that the knot  $K \subset A \times I$  is represented by a diagram on  $A$  such that the framing of  $K$  is the blackboard framing. In the relevant figures, the hole of the annulus  $A$  will be represented by an  $\mathbb{X}$ . The annulus itself will not be shown.

To prove Lemma 11, we will proceed in two steps: we will first prove the lemma in the special case where  $K$  is a 0-framed unknot, and then generalize our arguments to the case where  $K$  is an arbitrary framed oriented knot in  $A \times I$ . We will only prove that

$$[K^{\Sigma_i}] = \epsilon_{i1} \text{id}_{[K^n]} + \epsilon_{i2} [K^{E_i}]$$

for  $\epsilon_{i1}, \epsilon_{i2} \in \{\pm 1\}$ , as the proof of the second equation in Lemma 11 is nearly identical.

*Special case.* In the case where  $K$  is a 0-framed unknot, the cobordism  $K^{\Sigma_i}$  can be represented by the movie  $M^{\Sigma_i}$  shown in Figure 3. The first two diagrams in this movie (henceforth denoted

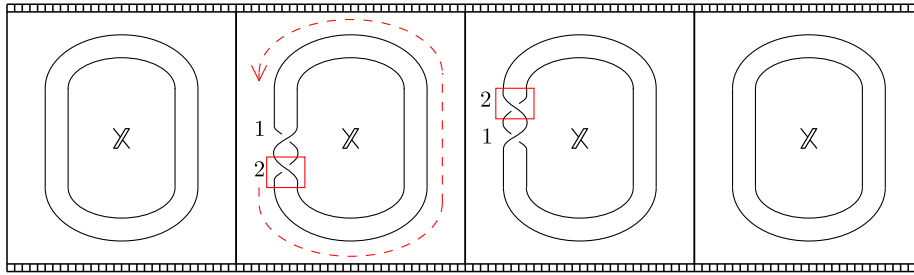

FIGURE 3. Movie  $M^{\Sigma_i}$  for the cobordism  $K^{\Sigma_i}: K^n \rightarrow K^n$  for the case where  $K$  is a 0-framed unknot. In this figure, we have only depicted the  $i$ th and the  $(i+1)$ st strands of  $K^n$ , as the other strands remain unchanged over the course of the movie.

$D_1$  and  $D_2$ ) differ by a Reidemeister II move, and the last two diagrams (henceforth denoted  $D_3$  and  $D_4$ ) differ by an inverse Reidemeister II move. The middle two diagrams differ by a planar isotopy which slides crossing 2 around the annulus in the direction of the dashed arrow while fixing crossing 1, so that at the end of the isotopy crossing 2 comes to lie above crossing 1.

The chain map  $[K^{\Sigma_i}]: [D_1] \rightarrow [D_4]$  induced by  $M^{\Sigma_i}$  is thus given by

$$[K^{\Sigma_i}] = G \circ \Psi \circ F,$$

where  $F$  denotes the chain map associated to the Reidemeister II move between  $D_1$  and  $D_2$ ,  $\Psi$  denotes the chain map induced by the isotopy between  $D_2$  and  $D_3$ , and  $G$  denotes the chain map associated to the inverse Reidemeister II move between  $D_3$  and  $D_4$ . Recalling the definition of  $F$  and  $G$  from [Bar05, §4.3], it thus follows that, up to possible signs,  $[K^{\Sigma_i}]$  is given by the rightward pointing arrows in the following diagram:

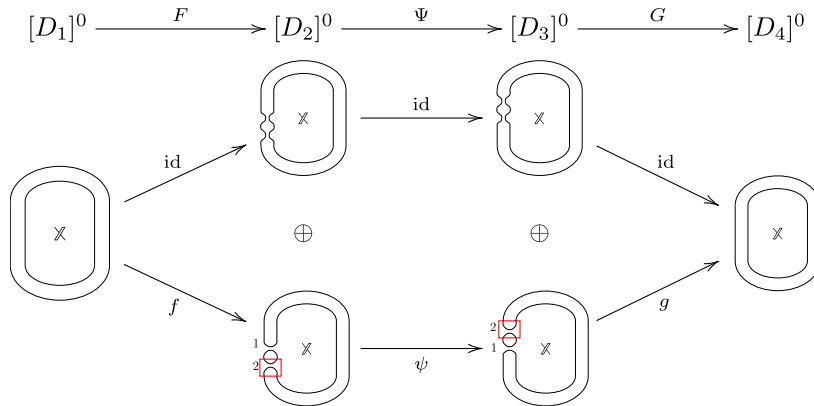

In this diagram, the four columns represent the 0th chain groups of the formal Khovanov brackets of  $D_j$  for  $j = 1, \dots, 4$ , and the arrows labeled  $f$ ,  $\psi$ , and  $g$  represent morphisms given by cobordisms in  $A \times I$ . It turns out that, up to possible signs,  $f$ ,  $\psi$ , and  $g$  are precisely the morphisms induced by moves between consecutive diagrams in the movie  $M^{E_i}$ , which is shown in Figure 4. In this movie, we intentionally left out two intermediate diagrams, one between the first two diagrams of the movie and one between the last two diagrams, to make Figure 4 look similar to Figure 3. Explicitly, the first two diagrams in Figure 4 differ by a saddle move followed by a creation of a small circle, and the last two diagrams differ by an annihilation of a small circle followed by a saddle move. The middle two diagrams differ by an isotopy which moves

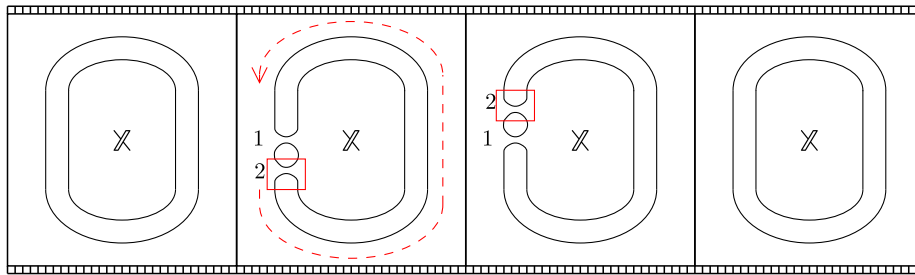

FIGURE 4. Movie  $M^{E_i}$  for the cobordism  $K^{E_i} : K^n \rightarrow K^n$  for the case where  $K$  is a 0-framed unknot.

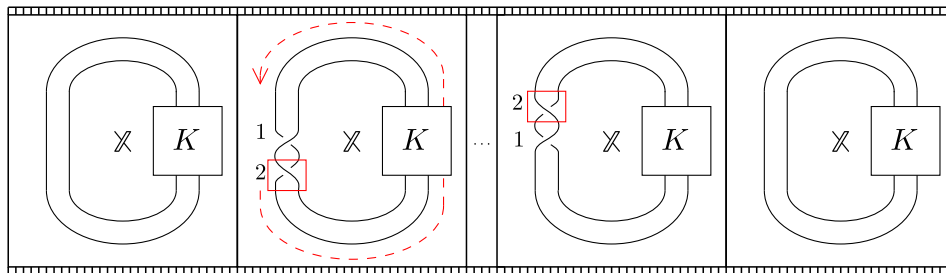

FIGURE 5. Movie  $M^{\Sigma_i}$  for the cobordism  $K^{\Sigma_i} : K^n \rightarrow K^n$ .

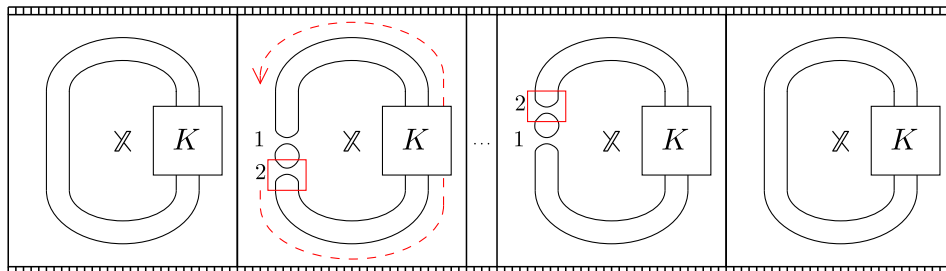

FIGURE 6. Movie  $M^{E_i}$  for the cobordism  $K^{E_i} : K^n \rightarrow K^n$ .

the interior of the small box containing the resolution of crossing 2 around the annulus in the direction of the dashed arrow, and which thereby turns the small circle in the second diagram into the elongated component in the third diagram, and *vice versa*.

It now follows from the above diagram that there exist  $\epsilon_{i1}, \epsilon_{i2} \in \{\pm 1\}$  such that

$$[K^{\Sigma_i}] = \epsilon_{i1}(\text{id} \circ \text{id} \circ \text{id}) + \epsilon_{i2}(g \circ \psi \circ f) = \epsilon_{i1} \text{id}_{[K^n]} + \epsilon_{i2}[K^{E_i}],$$

as desired.

*General case.* Now suppose that  $K$  is an arbitrary framed oriented knot in  $A \times I$ . In this case, the cobordisms  $K^{\Sigma_i}$  and  $K^{E_i}$  can be described by the movies  $M^{\Sigma_i}$  and  $M^{E_i}$  shown in Figures 5 and 6, respectively.

Note that these movies differ from the ones in Figures 3 and 4 in two ways: firstly each diagram in Figures 5 and 6 contains a ‘knotted’ part, which is represented by a box labeled  $K$ . Explicitly, this box stands for an  $n$ -cable diagram of a tangle whose closure is the knot  $K$ . Secondly, the movies in Figures 5 and 6 contain intermediate diagrams, which are represented

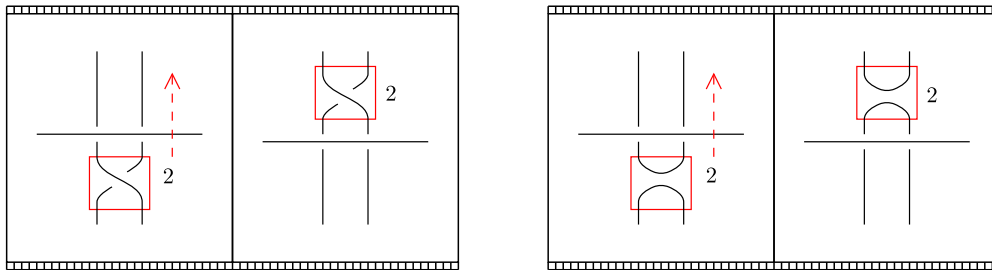

FIGURE 7. Sliding the small box across other strands.

in the figures by dots between the second and the second-to-last diagrams. These intermediate diagrams arise because one has to use Reidemeister moves of type III (in the case of Figure 5) and type II (in the case of Figure 6) to move the small box across possible over- and understrands located in the box labeled  $K$ . Local pictures of such Reidemeister moves are shown in Figure 7.

The chain map  $[K^{\Sigma_i}]: [K^n] \rightarrow [K^n]$  associated to the movie  $M^{\Sigma_i}$  is now given by

$$[K^n] = G \circ \Psi_\ell \circ \dots \circ \Psi_2 \circ \Psi_1 \circ F,$$

where  $F$  and  $G$  are as in the case where  $K$  is a 0-framed unknot, and  $\Psi_1, \Psi_2, \dots, \Psi_\ell$  are the chain maps induced by the Reidemeister III moves. To describe the maps  $\Psi_j: \left[ \frac{\parallel}{\text{X}_2} \right] \rightarrow \left[ \frac{\text{X}_2}{\parallel} \right]$  explicitly, we use that the Khovanov brackets of  $\frac{\parallel}{\text{X}_2}$  and  $\frac{\text{X}_2}{\parallel}$  can be viewed as mapping cones of chain maps

$$\varphi_j: \left[ \frac{\parallel}{\cup} \right] \rightarrow \left[ \frac{\parallel}{\text{X}} \right] \quad \text{and} \quad \varphi_{j+1}: \left[ \frac{\cup}{\parallel} \right] \rightarrow \left[ \frac{\text{X}}{\parallel} \right]$$

given by saddle cobordisms. The codomains of these two chain maps are both isotopic to  $\left[ \frac{\parallel}{\parallel} \right]$ , and both domains deformation retract to subcomplexes isomorphic to  $\left[ \frac{\cup}{\parallel} \right]$ . One can further show that, on these subcomplexes,  $\varphi_j$  and  $\varphi_{j+1}$  restrict to the same map

$$\varphi'_j: \left[ \frac{\cup}{\parallel} \right] \rightarrow \left[ \frac{\parallel}{\parallel} \right],$$

so it follows from [Bar05, Lemma 4.5] that the mapping cones of  $\varphi_j$  and  $\varphi_{j+1}$  are both homotopy equivalent to the mapping cone of  $\varphi'_j$  and hence to each other (see [Bar05, § 4.3] for more details). By tracing through the proof of [Bar05, Lemma 4.5], one can further show that the resulting homotopy equivalence  $\Psi_j: \left[ \frac{\parallel}{\text{X}_2} \right] \rightarrow \left[ \frac{\text{X}_2}{\parallel} \right]$  is given explicitly by three components, which are labeled  $\text{id}$ ,  $\psi_j$ , and  $\nu_j$  in the following diagram:

$$\begin{array}{ccc} \left[ \frac{\parallel}{\text{X}} \right] & \xrightarrow{\text{id}} & \left[ \frac{\text{X}}{\parallel} \right] \\ \uparrow \varphi_j & \nearrow \nu_j & \uparrow \varphi_{j+1} \\ \left[ \frac{\parallel}{\cup} \right] & \xrightarrow{\psi_j} & \left[ \frac{\cup}{\parallel} \right] \end{array}$$

In this diagram,  $\psi_j$  is the chain map induced by two consecutive Reidemeister II moves. The definition of the map  $\nu_j$  will not be relevant for the rest of this proof, but it will be important that the chain map  $\Psi_j$  does not have a component going from  $\left[ \begin{array}{c} | \\ | \\ | \\ \times \end{array} \right]$  to  $\left[ \begin{array}{c} \cup \\ | \\ | \\ | \end{array} \right]$ . That this is so follows from the fact that the top right entries in the matrices for  $\tilde{G}_0^r$  and  $\tilde{F}_0^r$  in [Bar05, Figure 8] are zero.

The chain map  $[K^{\Sigma_i}]$  associated to the movie  $M^{\Sigma_i}$  is thus given by the composition of the rightward pointing arrows in the following diagram, in which  $f$  and  $g$  are as in the case where  $K$  is a 0-framed unknot:

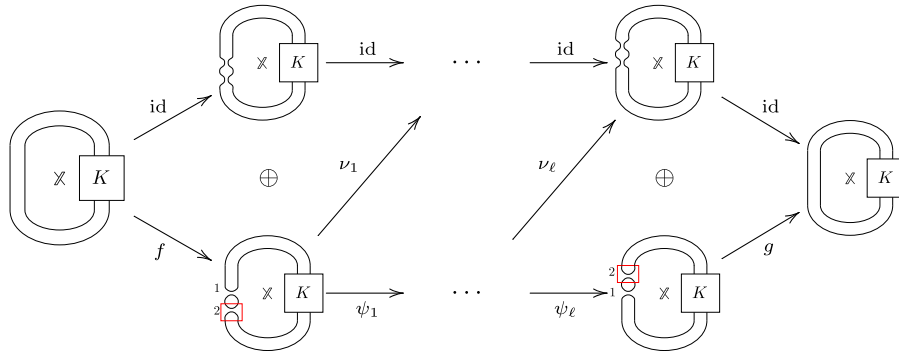

The lemma now follows from the following claim.

CLAIM. *The maps  $\nu_1, \nu_2, \dots, \nu_\ell$  do not contribute to  $[K^{\Sigma_i}]$ . That is, there are signs  $\epsilon_{i1}, \epsilon_{i2} \in \{\pm 1\}$  such that*

$$[K^{\Sigma_i}] = \epsilon_{i1}(\text{id} \circ \dots \circ \text{id}) + \epsilon_{i2}(g \circ \psi_\ell \circ \dots \circ \psi_1 \circ f) = \epsilon_{i1} \text{id}_{[K^n]} + \epsilon_{i2}[K^{E_i}],$$

as desired.

*Proof of the claim.* Let  $D_1, \dots, D_{\ell+3}$  be the link diagrams that appear in the movie  $M^{\Sigma_i}$ . We will say that a crossing of  $D_j$  has type 1 (respectively, type 2) if it is one of the crossings that were already present in  $D_1$  (respectively, if it is one of the two crossings labeled 1 and 2 in Figures 5 and 7). Moreover, we will regard  $[D_j]$  as a bicomplex, where the first and the second differentials in the bicomplex are given by all edge maps in the resolution cube of  $D_j$  which correspond to crossings of type 1 and type 2, respectively. Corresponding to the two differentials, there are two cohomological gradings, denoted  $i_1$  and  $i_2$ , whose sum is equal to the total cohomological degree on  $[D_j]$ . (Explicitly, these two gradings are defined by  $i_m := k_m - n_{m-}$ , where  $k_m$  denotes the number of 1-resolutions at crossings of type  $m$ , and  $n_{m-}$  denotes the number of negative crossings of type  $m$ , with respect to a fixed orientation for  $K^n$ .)

Now note that each  $\nu_j$  raises the  $i_2$ -degree by 1 (and hence lowers the  $i_1$ -degree by 1). Indeed, this follows because  $\nu_j$  turns a 0-resolution at the crossing labeled 2 into a 1-resolution while leaving the resolution at the crossing labeled 1 unchanged. (Here we assume that crossings are labeled as in Figures 5 and 7.) Moreover, it is easy to see that all other maps in the above diagram preserve the  $i_1$ - and the  $i_2$ -degrees. It thus follows that the chain map  $[K^{\Sigma_i}]: [D_1] \rightarrow [D_{\ell+3}]$  can be written as

$$[K^{\Sigma_i}] = [K^{\Sigma_i}]_0 + [K^{\Sigma_i}]_+,$$

where  $[K^{\Sigma_i}]_0$  preserves the  $i_2$ -degree and  $[K^{\Sigma_i}]_+$  strictly raises the  $i_2$ -degree. But since  $[D_1]$  and  $[D_{\ell+3}]$  are supported in  $i_2$ -degree 0 (essentially by definition of the  $i_2$ -degree), it follows that  $[K^{\Sigma_i}]_+$  has to be zero and hence the  $\nu_j$  cannot contribute to  $[K^{\Sigma_i}]$  because they could only contribute to  $[K^{\Sigma_i}]_+$ .  $\square$



PROPOSITION 11. *If  $S : K_1 \rightarrow K_2$  is a framed annular knot cobordism, then there is an induced homomorphism of  $\mathfrak{S}_n$  representations  $\text{SKh}(K_1^n) \rightarrow \text{SKh}(K_2^n)$ .*

*Proof.* Let  $S : K_1 \rightarrow K_2$  be a framed knot cobordism. Then the  $n$ -cable of  $S$  (defined by taking  $n$  parallel copies of  $S$ ) is a link cobordism  $S^n : K_1^n \rightarrow K_2^n$  and hence there is an induced map

$$\text{SKh}(K_1^n) \longrightarrow \text{SKh}(K_2^n).$$

To show that this map commutes with the  $\mathfrak{S}_n$  actions, we first note that if  $\Sigma_i$  is one of the generators shown in Figure 2, then the maps

$$[S^n] \circ [K_1^{\Sigma_i}] \quad \text{and} \quad [K_2^{\Sigma_i}] \circ [S^n]$$

agree up to an overall sign because the cobordisms

$$S^n \circ K_1^{\Sigma_i} \quad \text{and} \quad K_2^{\Sigma_i} \circ S^n$$

are isotopic.

Now let  $o_p$  and  $o'_p$  denote the parallel orientations of  $K_1^n$  and  $K_2^n$  (i.e., the orientations for which all strands of the  $n$ -cable are oriented parallel to the orientation of the original knot). Since the orientations  $o_p$  and  $o'_p$  are consistent with the parallel orientation of  $S^n$ , Theorem 3 implies that the matrix entry  $(\phi'_{S^n})_{o'_p o_p}$  of the induced map in Lee homology is non-zero. Moreover, Convention 1 implies that the matrix entries  $(\phi'_{K_1^{\Sigma_i}})_{o_p o_p}$  and  $(\phi'_{K_2^{\Sigma_i}})_{o'_p o'_p}$  are equal to 1, and Theorem 3 shows that all other entries in the same row and the same column of the matrices of  $\phi'_{K_1^{\Sigma_i}}$  and  $\phi'_{K_2^{\Sigma_i}}$  are 0. Now a direct calculation shows that

$$(\phi'_{S^n} \circ \phi'_{K_1^{\Sigma_i}})_{o'_p o_p} \quad \text{and} \quad (\phi'_{K_2^{\Sigma_i}} \circ \phi'_{S^n})_{o'_p o_p}$$

are both equal to  $(\phi'_{S^n})_{o'_p o_p}$  and, since  $(\phi'_{S^n})_{o'_p o_p}$  is non-zero, this means that the signs of  $\phi'_{S^n} \circ \phi'_{K_1^{\Sigma_i}}$  and  $\phi'_{K_2^{\Sigma_i}} \circ \phi'_{S^n}$  have to be the same.

Finally, since Lee homology and sutured Khovanov homology can be obtained from the formal Khovanov bracket by applying additive functors, the same result remains true for the maps  $[S^n] \circ [K_1^{\Sigma_i}]$  and  $[K_2^{\Sigma_i}] \circ [S^n]$  and for the induced maps in sutured Khovanov homology.  $\square$

### 7.5 Direct limits

Let  $K$  be an oriented, framed knot in  $A \times I$ . There is a natural Temperley–Lieb cobordism  $S_k^{[n,n+2]}$  from the  $n$ -cable  $K^n$  to the  $(n+2)$ -cable  $K^{n+2}$ , defined by

$$S_k^{[n,n+2]} := K^{\cup_{n,n+2}} = \tau(S^1 \times \cup_{n,n+2}),$$

where  $\cup_{n,n+2}$  is the cup tangle shown in the left half of Figure 8, and  $\tau$  is the embedding  $\tau : S^1 \times D^2 \times I \rightarrow A \times I \times I$  introduced in Definition 6.

LEMMA 13. *The map induced by  $S_k^{[n,n+2]}$  gives an injection*

$$\text{SKh}(K^n) \hookrightarrow \text{SKh}(K^{n+2}).$$

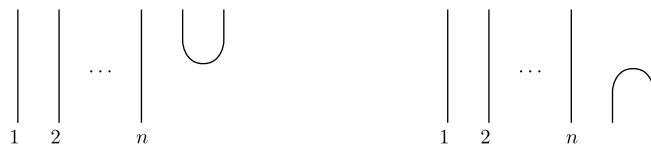

FIGURE 8. Tangles  $U_{n,n+2}$  and  $\cap_{n+2,n}$ .

*Proof.* Dually to  $S_k^{[n,n+2]}$ , we have a cobordism  $S_k^{[n+2,n]} := K^{\cap_{n+2,n}}$ , where  $\cap_{n+2,n}$  is the tangle shown in the right half of Figure 8. The composition

$$\mathrm{SKh}(K^n) \rightarrow \mathrm{SKh}(K^{n+2}) \rightarrow \mathrm{SKh}(K^n)$$

of the maps induced by  $S_k^{[n,n+2]}$  and  $S_k^{[n+2,n]}$  is  $\pm 2\mathrm{id}$ . Thus, the first map  $\mathrm{SKh}(K^n) \rightarrow \mathrm{SKh}(K^{n+2})$  is injective.  $\square$

As a result, we may form the direct limits

$$\mathrm{SKh}^{\mathrm{even}}(K) = \varinjlim_n \mathrm{SKh}(K^{2n}),$$

$$\mathrm{SKh}^{\mathrm{odd}}(K) = \varinjlim_n \mathrm{SKh}(K^{2n+1}).$$

These spaces are invariants of the framed knot  $K$ , and we expect them to have interesting symmetry. In particular, note that both  $\mathrm{SKh}^{\mathrm{even}}(K)$  and  $\mathrm{SKh}^{\mathrm{odd}}(K)$  have commuting actions of  $\mathfrak{sl}_2(\wedge)$  and the infinite symmetric group  $\mathfrak{S}_\infty = \varinjlim_n \mathfrak{S}_n$ . Commuting actions of  $\mathfrak{sl}_2$  and the infinite symmetric group have appeared in the literature recently in connection with the representation theory of infinite-dimensional Lie algebras (see, for example, [TV14] and the references therein). We therefore pose the following question.

*Question 1.* Can one construct actions of the infinite-dimensional affine Lie algebra  $\widehat{\mathfrak{sl}}_2$  or the Virasoro algebra on the homology groups  $\mathrm{SKh}^{\mathrm{even}}(K)$  and  $\mathrm{SKh}^{\mathrm{odd}}(K)$ ?

### 7.6 Colored SKh

Let  $K$  be an oriented, framed knot in  $A \times I$ . We define the  $n$ -colored sutured Khovanov homology of  $K$  as the subspace

$$\mathrm{SKh}_n(K) := \mathrm{SKh}(K^n)^{\mathfrak{S}_n} \subset \mathrm{SKh}(K^n)$$

of  $\mathfrak{S}_n$  invariants inside  $\mathrm{SKh}(K^n)$ . This definition is motivated by the following result, which holds for ordinary Khovanov homology of  $n$ -cables of knots in  $\mathbb{R}^3$  and which will be proven in a forthcoming paper by Beliakova, Putyra and the third author.

**THEOREM 4.** *Let  $K$  be an oriented, framed knot in  $\mathbb{R}^3$ . Then the subspace of  $\mathfrak{S}_n$  invariants inside the Khovanov homology of  $K^n$  (with coefficients in a field of characteristic 0) is isomorphic to Khovanov’s categorification of the non-reduced  $n$ -colored Jones polynomial of  $K$  [Kho05].*

## 8. The category of finite-dimensional representations of $\mathfrak{sl}_2(\wedge)$

Let  $\mathrm{rep}(\mathfrak{sl}_2(\wedge))$  denote the category of finite-dimensional graded representations of  $\mathfrak{sl}_2(\wedge)$ . In this section we give a quiver description of the category  $\mathrm{rep}(\mathfrak{sl}_2(\wedge))$ , which is seen to be equivalent to the category of finitely generated graded representations of a finite-dimensional Koszul algebra.

Let  $\Gamma$  denote the quiver with vertex set  $\mathbb{N} = \{0, 1, 2, \dots\}$  and a single oriented edge from vertex  $i$  to each of the vertices  $i - 2, i,$  and  $i + 2$ . (Thus, the underlying graph of  $\Gamma$  has two connected components, one of which contains the odd vertices and the other of which contains the even vertices.) We denote the individual edges of  $\Gamma$  by  $\alpha_i, \beta_i,$  and  $\epsilon_i,$  as in the picture below.

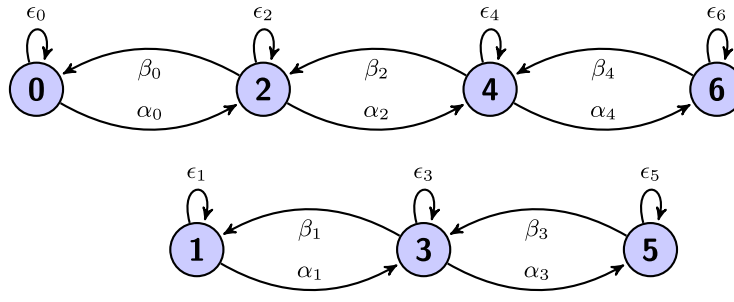

PROPOSITION 12. *The category  $\text{rep}(\mathfrak{sl}_2(\wedge))$  is equivalent to the category of representations of the quiver  $\Gamma$  with the following relations. For all  $i \in \mathbb{N}$ , we have:*

- $\alpha_{i+2}\alpha_i = 0;$
- $\beta_{i-2}\beta_i = 0;$
- $\epsilon_{i+2}\alpha_i + \alpha_i\epsilon_i = 0;$
- $\epsilon_i\beta_i + \beta_i\epsilon_{i+2} = 0;$
- $\beta_i\alpha_i + \alpha_{i-2}\beta_{i-2} + \epsilon_i^2 = 0;$  and
- $\beta_i\alpha_i + (i^2/4(i + 3))\epsilon_i^2 = 0.$

By convention, we take  $\alpha_i = \beta_i = \epsilon_i = 0$  in the above relations when  $i < 0$ .

*Proof.* We describe the functor  $Q$  from  $\mathfrak{sl}_2(\wedge)$  representations to  $\Gamma$  representations which gives the equivalence. Let  $M$  be a finite-dimensional representation of  $\mathfrak{sl}_2(\wedge)$  and, for  $i \in \mathbb{N}$ , let  $E_i = \{m \in M : h(m) = im \text{ and } e(m) = 0\}$  denote the space of highest-weight vectors of  $M$  regarded as a finite-dimensional representation of  $\mathfrak{sl}_2$ . Then the commutation relations between  $e$  and  $v_j, j = 2, 0, -2,$  give:

- $v_2 : E_i \rightarrow E_{i+2};$
- $v_0 : E_i \rightarrow E_i \oplus f(E_{i+2});$  and
- $v_{-2} : E_i \rightarrow E_{i-2} \oplus f(E_i) \oplus f^2(E_{i+2}).$

Moreover, for  $m \in E_i,$  we may write

$$v_0(m) = p_i(m) - \frac{2}{i+2}fv_2(m)$$

and

$$v_{-2}(m) = q_{i-2}(m) + \frac{1}{i}fp_i(m) - \frac{1}{(i+1)(i+2)}f^2v_2(m),$$

where  $p_i(m) \in E_i$  and  $q_{i-2}(m) \in E_{i-2}.$

Now, setting

$$\alpha_i = (i + 3)v_2 : E_i \longrightarrow E_{i+2},$$

$$\epsilon_i = \frac{1}{i}p_i : E_i \longrightarrow E_i$$

and

$$\beta_i = \frac{1}{i+2}q_i : E_{i+2} \longrightarrow E_i,$$

the defining relations  $[v_k, v_l] = 0$  for  $k, l \in \{2, 0, -2\}$  give rise to the relations given in the theorem. The inverse functor  $Q^{-1}$  takes a representation  $E$  of the quiver  $\Gamma$  and declares the vector space  $E_i$  to be the space of highest-weight vectors of weight  $i$ ; in other words, as an  $\mathfrak{sl}_2$  representation, we have

$$Q^{-1}(E) \cong \bigoplus_i V_{(i)} \otimes E_i.$$

The action of  $v_2, v_0, v_{-2}$  on highest-weight vectors is then determined by the representation of the quiver, together with

$$v_0(m) = p_i(m) - \frac{2}{i+2} f v_2(m)$$

and

$$v_{-2}(m) = q_{i-2}(m) + \frac{1}{i} f p_i(m) - \frac{1}{(i+1)(i+2)} f^2 v_2(m),$$

and the commutation relations between  $\mathfrak{sl}_2$  and  $v_2, v_0, v_{-2}$  determine the action on the rest of  $\bigoplus_i V_{(i)} \otimes E_i$ . It is then clear from this that  $Q$  and  $Q^{-1}$  are inverse equivalences.  $\square$

*Remark 11.* An analog of the theorem above for the (non-super) current Lie algebra  $\mathfrak{sl}_2(V_{(1)})$ , where  $V_{(1)}$  is the two-dimensional irrep of  $\mathfrak{sl}_2$ , is due to Loupias [Lou72]; see also [HK01].

### 9. Examples

#### 9.1 Schur–Weyl representation and trivial braid closures

Recall that if  $V = \mathbb{C}^2$  is the defining representation of  $\mathfrak{sl}_2$ , then we have a natural action of  $\mathfrak{S}_n$  on the  $n$ -fold tensor product, extended linearly from:

$$\sigma(v_1 \otimes \cdots \otimes v_n) := v_{\sigma^{-1}(1)} \otimes \cdots \otimes v_{\sigma^{-1}(n)}$$

for  $\sigma \in \mathfrak{S}_n, v_i \in V$ . We also have the induced tensor product action of  $\mathfrak{sl}_2$ , extended  $\mathbb{C}$ -linearly from:

$$x(v_1 \otimes \cdots \otimes v_n) := \sum_{i=1}^n v_1 \otimes \cdots \otimes x(v_i) \otimes \cdots \otimes v_n$$

for  $x \in \mathfrak{sl}_2$ . These actions commute. We will refer to the resulting action of  $\mathfrak{sl}_2 \times \mathfrak{S}_n$  on  $V^{\otimes n}$  as the *Schur–Weyl representation*.

*Remark 12.* In what follows we will be considering the Schur–Weyl representation on  $V^{\otimes \lfloor n/2 \rfloor} \otimes (V^*)^{\otimes \lceil n/2 \rceil}$  (where the order of the terms in the tensor product alternates between  $V$  and  $V^*$ ). If  $\{v_{\pm}\}$  is the standard basis of  $V$  and  $\{\bar{v}_{\pm}\}$  is the standard basis of  $V^*$ , then the isomorphism  $\phi : V \rightarrow V^*$  is a diagonal matrix with entries in  $\pm 1$ :  $\phi(v_{\pm}) = \pm \bar{v}_{\pm}$ . As a consequence, the formulas for the action of the transposition  $(i j) \in \mathfrak{S}_n$  on a tensor product of standard basis vectors will also carry the sign  $(-1)^{i-j}$ .

**PROPOSITION 13.** *Let  $\mathbb{1}_n$  denote the trivial  $n$ -strand braid and  $\widehat{\mathbb{1}}_n$  its closure, understood as the 0-framed  $n$ -cable of the unknot.*

- (1) *The actions of  $v_{-2}, v_0, v_2 \in \mathfrak{sl}_2(\wedge)$  on  $\text{SKh}(\widehat{\mathbb{1}}_n)$  are trivial and hence the action of  $\mathfrak{sl}_2(\wedge)$  on  $\text{SKh}(\widehat{\mathbb{1}}_n)$  reduces to an action of  $\mathfrak{sl}_2$ .*
- (2) *The commuting actions of  $\mathfrak{sl}_2$  and  $\mathfrak{S}_n$  on  $\text{SKh}(\widehat{\mathbb{1}}_n)$  agree with the Schur–Weyl representation.*

*Proof.* Using the functor  $\mathcal{F}$  described in § 4.2 applied to the crossing-less diagram for  $\widehat{\mathbb{1}}_n$ , we see that as an  $\mathfrak{sl}_2$  representation,  $\text{SKh}(\widehat{\mathbb{1}}_n) \cong V^{\otimes \lceil n/2 \rceil} \otimes (V^*)^{\otimes \lfloor n/2 \rfloor} \cong V^{\otimes n}$  and is concentrated in  $(i, j')$  grading  $(0, 0)$ . It follows that the actions of  $v_{-2}, v_0, v_2 \in \mathfrak{sl}_2(\wedge)$  are trivial, as each shifts the  $i$  grading by 1.

We would now like to see that the action of  $\mathfrak{S}_n$  on  $\text{SKh}(\widehat{\mathbb{1}}_n)$  agrees with the standard commuting action of  $\mathfrak{S}_n$  in the Schur–Weyl representation. If we regard a standard basis element of  $\text{SKh}(\widehat{\mathbb{1}}_n)$ , i.e., one of the form

$$v_{\pm} \otimes \bar{v}_{\pm} \otimes \cdots \otimes \bar{v}_{\pm} \otimes v_{\pm} \in V \otimes V^* \otimes \cdots \otimes V^* \otimes V$$

(in the odd- $n$  case), as a labeling of the corresponding circles of the (unique) resolution by pluses and minuses, this amounts to verifying that the transposition  $t_i = (i \ i + 1) \in \mathfrak{S}_n$  exchanges the markings on the  $i$ th and  $(i + 1)$ st strands and multiplies the resulting vector by  $-1$ . This follows by appealing to Proposition 9. In particular, the cobordism map associated to  $t_i$  is  $\text{id} + u_i$ , where  $u_i$  is the Temperley–Lieb map described by the cobordism in Figure 4 (using Conventions 1 and 2 to pin down signs). One quickly computes that the map  $u_i$  is 0 on any standard basis vector whose  $i$ th and  $(i + 1)$ st labels agree. If the  $i$ th and  $(i + 1)$ st labels disagree, one computes

$$u_i(\cdots \otimes (v_{\pm} \otimes \bar{v}_{\mp}) \otimes \cdots) = (\cdots \otimes (-v_{\pm} \otimes \bar{v}_{\mp} - v_{\mp} \otimes \bar{v}_{\pm}) \otimes \cdots).$$

We conclude that the action of  $t_i = 1 + u_i$  agrees with the  $\mathfrak{S}_n$  action in the Schur–Weyl representation, as desired.  $\square$

### 9.2 Positive stabilizations of the non-trivial annular unknot

Let

- $\widehat{\beta}_n :=$  the  $n$ -fold positive stabilization of the non-trivial unknot
- $=$  the annular closure of the braid  $\beta_n := \sigma_1 \sigma_2 \cdots \sigma_n \in \mathfrak{B}_{n+1}$ ,
- $V_{(m)} :=$  the  $(m + 1)$ -dimensional irreducible representation of  $\mathfrak{sl}_2$ .

PROPOSITION 14. *For all  $n \geq 0$ , we have*

$$\text{SKh}^i(\widehat{\beta}_n) \cong \begin{cases} V_{(n+1)}\{n\} & \text{if } i = 0, \\ V_{(n-1)}\{n + 2\} & \text{if } i = 1, \\ 0 & \text{else,} \end{cases}$$

where  $\{m\}$  denotes the grading-shift functor which raises the  $j' := (j - k)$  degree by  $m \in \mathbb{Z}$  and preserves the  $k$  degree. As a module over  $\mathfrak{sl}_2(\wedge)$ ,  $\text{SKh}(\widehat{\beta}_n)$  is indecomposable, with module structure determined by the  $\mathfrak{sl}_2$  decomposition above together with the fact that the generator  $v_{-2}$  of  $\mathfrak{sl}_2(\wedge)$  takes a highest-weight vector in  $V_{(n+1)}$  to a highest-weight vector in  $V_{(n-1)}$ .

*Proof.* The proof goes by induction on  $n$ . For  $n = 0$ , we have

$$\text{SKh}^i(\widehat{\beta}_0) = \text{SKh}^i(\text{non-trivial annular unknot}) = \begin{cases} V_{(1)}\{0\} & \text{if } i = 0, \\ 0 & \text{else} \end{cases}$$

and hence the statement of the proposition is satisfied because  $V_{(-1)} = 0$ . For  $n = 1$ , the sutured annular Khovanov complex of  $\widehat{\beta}_n$  is isomorphic to

$$0 \longrightarrow \begin{array}{c} V_{(2)}\{1\} \\ \oplus \\ V_{(0)}\{1\} \end{array} \xrightarrow{\delta_0} \begin{array}{c} V_{(0)}\{3\} \\ \oplus \\ V_{(0)}\{1\} \end{array} \longrightarrow 0,$$

where

$$\delta_0 = \begin{bmatrix} 0 & 0 \\ 0 & 1 \end{bmatrix}$$

and so the proposition holds in this case as well.

To prove the proposition for  $n > 1$ , we use that the sutured annular Khovanov complex of  $\widehat{\beta}_n$ , denoted  $C(\widehat{\beta}_n)$ , can be written as a mapping cone<sup>8</sup>

$$C(\widehat{\beta}_n) \cong \text{Cone} (C(\widehat{\beta}_{n;0})\{1\} \xrightarrow{f} C(\widehat{\beta}_{n;1})\{2\}),$$

where  $\widehat{\beta}_{n;0}$  (respectively,  $\widehat{\beta}_{n;1}$ ) denotes the annular link diagram obtained from  $\widehat{\beta}_n = \sigma_1 \cdots \sigma_n$  by replacing the unique crossing in  $\sigma_n$  by its 0-resolution (respectively, its 1-resolution) and  $f$  is the chain map induced by a saddle cobordism between the 0- and the 1-resolutions of this crossing. It follows from the properties of the mapping cone that there is a short exact sequence of chain complexes

$$0 \longrightarrow C^{*-1}(\widehat{\beta}_{n;1})\{2\} \longrightarrow C^*(\widehat{\beta}_n) \longrightarrow C^*(\widehat{\beta}_{n;0})\{1\} \longrightarrow 0,$$

which induces a long exact sequence in homology:

$$\cdots \longrightarrow \text{SKh}^{i-1}(\widehat{\beta}_{n;1})\{2\} \longrightarrow \text{SKh}^i(\widehat{\beta}_n) \longrightarrow \text{SKh}^i(\widehat{\beta}_{n;0})\{1\} \longrightarrow \text{SKh}^i(\widehat{\beta}_{n;1})\{2\} \longrightarrow \cdots .$$

Looking at  $\widehat{\beta}_{n;0}$  and  $\widehat{\beta}_{n;1}$ , one further sees that these diagrams represent the same annular links as the diagrams  $\widehat{\beta}_{n-1} \times 1$  and  $\widehat{\beta}_{n-2}$ , respectively, and hence one can write the above long exact sequence as

$$\cdots \longrightarrow \text{SKh}^{i-1}(\widehat{\beta}_{n-2})\{2\} \longrightarrow \text{SKh}^i(\widehat{\beta}_n) \longrightarrow \text{SKh}^i(\widehat{\beta}_{n-1}) \otimes V_{(1)}\{1\} \longrightarrow \cdots ,$$

where we have used that  $\text{SKh}^i(\widehat{\beta}_{n-1} \times 1) = \text{SKh}^i(\widehat{\beta}_{n-1}) \otimes V_{(1)}$  as  $\mathfrak{sl}_2$  modules. (The existence of an isomorphism  $\text{SKh}^i(\widehat{\beta}_{n-1} \times 1) = \text{SKh}^i(\widehat{\beta}_{n-1}) \otimes V_{(1)}$  of  $k$ -graded vector spaces implies the existence of an isomorphism as  $\mathfrak{sl}_2$  modules, since the  $\mathfrak{sl}_2$ -module structure is determined up to isomorphism by its weight space decomposition, which is just its  $k$ -graded dimension.)

We now use induction on  $n$  and the fact that  $V_{(m)} \otimes V_{(1)} \cong V_{(m+1)} \oplus V_{(m-1)}$  to write the non-trivial part of the above long exact sequence as

$$\begin{array}{ccccc} 0 & \longrightarrow & \text{SKh}^0(\widehat{\beta}_n) & \longrightarrow & V_{(n+1)}\{n\} \oplus V_{(n-1)}\{n\} \\ & & & \searrow^{c_0} & \\ V_{(n-1)}\{n\} & \longleftarrow & \text{SKh}^1(\widehat{\beta}_n) & \longrightarrow & V_{(n-1)}\{n+2\} \oplus V_{(n-3)}\{n+2\} \\ & & & \searrow^{c_1} & \\ V_{(n-3)}\{n+2\} & \longleftarrow & \text{SKh}^2(\widehat{\beta}_n) & \longrightarrow & 0, \end{array}$$

where  $c_0$  and  $c_1$  are connecting homomorphisms.

<sup>8</sup> The diagram  $\widehat{\beta}_{n;0}$  does not inherit a consistent orientation from  $\widehat{\beta}_n$ . However, it turns out that because of the particular form of  $\widehat{\beta}_n$ , one can choose an orientation for  $\widehat{\beta}_{n;0}$  which almost agrees with the orientation of  $\widehat{\beta}_n$ , in the sense that it differs from the latter orientation only along a crossing-less arc. The grading shifts in the mapping cone description of  $C(\widehat{\beta}_n)$  arise because, in the construction of Khovanov homology, the  $j$  degree is shifted by  $r + n_+ - 2n_-$ , where  $r$  denotes the number of 1-resolutions and  $n_+/n_-$  denotes the number of positive/negative crossings.

LEMMA 14.  $c_0$  and  $c_1$  are non-zero.

*Proof.* Let  $g_{n-1} \in C^0(\widehat{\beta_{n-1}})\{1\}$  denote the element obtained by labeling all circles in the all-0-resolution of  $\widehat{\beta_{n-1}}$  by  $v_-$ . Moreover, let  $R_{n-1}(\ell)$  denote the resolution of  $\widehat{\beta_{n-1}}$  obtained by choosing the 1-resolution at the  $\ell$ th crossing of  $\widehat{\beta_{n-1}}$  and the 0-resolution at all other crossings. Further, let  $g'_{n-1}(\ell) \in C^1(\widehat{\beta_{n-1}})\{1\}$  be the element given by labeling the trivial circle in  $R_{n-1}(\ell)$  by  $w_+$  and each non-trivial circle in  $R_{n-1}(\ell)$  by  $v_-$ . Define

$$g'_{n-1} := \bigoplus_{\ell=1}^{n-1} g'_{n-1}(\ell) \in C^1(\widehat{\beta_{n-1}})\{1\}.$$

We now leave it to the reader to verify that

$$c_0([g_{n-1} \otimes v_+]) = [g_{n-2}] \quad \text{and} \quad c_1([g'_{n-1} \otimes v_+]) = [g'_{n-2}].$$

Using the same sign conventions as in [Bar05], one can further see that the elements  $g_{n-1}$ ,  $g'_{n-1}$ ,  $g_{n-2}$ ,  $g'_{n-2}$  are cycles, and that none of them is a boundary. It follows that  $c_0$  and  $c_1$  are non-zero.  $\square$

The inductive step in the proof of Proposition 14 now follows from the above long exact sequence and from Lemma 14, coupled with the facts that (a) an  $\mathfrak{sl}_2$ -module map between two non-isomorphic irreducible  $\mathfrak{sl}_2$ -modules is necessarily zero, and (b) an  $\mathfrak{sl}_2$ -module map between two isomorphic irreducible  $\mathfrak{sl}_2$ -modules is either zero or an isomorphism.

The claim about the action of  $\mathfrak{sl}_2(\wedge)$  is now a straightforward computation, which we leave as an exercise.  $\square$

### 9.3 Annular $(2, -n)$ -torus links for $n \geq 0$

Let

$$\begin{aligned} T_{2,-n} &:= \text{the annular } (2, -n)\text{-torus link} \\ &= \text{the annular closure of the braid } \sigma_1^{-n} \in \mathfrak{B}_2. \end{aligned}$$

In the case where  $n$  is even, we assume that both components of  $T_{2,-n}$  are oriented parallel to each other, in direction of the braid  $\sigma_1^{-n}$ .

PROPOSITION 15. For all  $n \geq 1$ , we have

$$\text{SKh}^i(T_{2,-n}) \cong \begin{cases} V_{(2)}\{-n\} & \text{if } i = 0, \\ V_{(0)}\{2i - n\} & \text{if } -n \leq i \leq -1 \text{ and } i \text{ odd,} \\ V_{(0)}\{2i + 2 - n\} & \text{if } -n + 1 \leq i \leq -2 \text{ and } i \text{ even,} \\ V_{(0)}\{-3n + 2\} \oplus V_{(0)}\{-3n\} & \text{if } i = -n \text{ and } n \text{ even,} \\ 0 & \text{else.} \end{cases}$$

The  $\mathfrak{sl}_2(\wedge)$ -module structure on  $\text{SKh}(T_{2,-n})$  is completely determined by the fact that the generator  $v_2$  of  $\mathfrak{sl}_2(\wedge)$  takes a highest-weight vector of the summand  $V_{(0)}\{-n - 2\}$  to a highest-weight vector of  $V_{(2)}\{-n\}$  and annihilates all other  $V_{(0)}$  summands. Thus,  $\text{SKh}(T_{2,-n})$  is an indecomposable  $\mathfrak{sl}_2(\wedge)$  module if and only if  $n = 1$ .

*Proof.* The proof goes by induction on  $n$  and is similar to the proof of Proposition 14. For  $n = 1$ , the complex  $C(T_{2,-n})$  is isomorphic to

$$0 \longrightarrow \begin{matrix} V_{(0)}\{-1\} \\ \oplus \\ V_{(0)}\{-3\} \end{matrix} \xrightarrow{\delta_{-1}} \begin{matrix} V_{(2)}\{-1\} \\ \oplus \\ V_{(0)}\{-1\} \end{matrix} \longrightarrow 0,$$

where

$$\delta_0 = \begin{bmatrix} 0 & 0 \\ 1 & 0 \end{bmatrix},$$

and hence the proposition is satisfied in this case.

To prove the proposition for  $n > 1$ , we write  $C(T_{2,-n})$  as a mapping cone

$$C(T_{2,-n}) \cong \text{Cone}(C(T_{2,-n;0})\{-3n + 1\}[-n] \xrightarrow{g} C(T_{2,-n;1})\{-1\}[-1]),$$

where  $[m]$  denotes a shift of the homological grading by  $m \in \mathbb{Z}$ , and  $T_{2,-n;0}$  (respectively,  $T_{2,-n;1}$ ) denotes the diagram obtained from  $T_{2,-n} = \widehat{\sigma_1^{-n}}$  by replacing the crossing in the last  $\sigma_1^{-1}$  in  $\sigma_1^{-n}$  by its 0-resolution (respectively, by its 1-resolution).<sup>9</sup> As in the proof of Proposition 14, we obtain a long exact sequence

$$\dots \longrightarrow \text{SKh}^i(T_{2,-n;1})\{-1\} \longrightarrow \text{SKh}^i(T_{2,-n}) \longrightarrow \text{SKh}^{i+n}(T_{2,-n;0})\{-3n + 1\} \longrightarrow \dots$$

and, by observing that  $T_{2,-n;0}$  represents a trivial annular unknot, and  $T_{2,-n;1}$  represents  $T_{2,-(n-1)}$ , we can write this long exact sequence as

$$\dots \rightarrow \text{SKh}^i(T_{2,-(n-1)})\{-1\} \rightarrow \text{SKh}^i(T_{2,-n}) \rightarrow \text{SKh}^{i+n}(\text{trivial unknot})\{-3n + 1\} \xrightarrow{c_{i+n}} \dots,$$

where

$$c_{i+n}: \text{SKh}^{i+n}(\text{trivial unknot})\{-3n + 1\} \longrightarrow \text{SKh}^{i+1}(T_{2,-(n-1)})\{-1\}$$

is the connecting homomorphism.

LEMMA 15.  $c_{i+n}$  is zero unless  $n$  is odd and  $i + n = 0$ . Moreover, if  $n$  is odd, then

$$c_0: \text{SKh}^0(\text{trivial unknot})\{-3n + 1\} \longrightarrow \text{SKh}^{-n+1}(T_{2,-(n-1)})\{-1\}$$

is conjugate to the map

$$\begin{matrix} V_{(0)}\{-3n + 2\} \\ \oplus \\ V_{(0)}\{-3n\} \end{matrix} \xrightarrow{c'_0} \begin{matrix} V_{(0)}\{-3n + 4\} \\ \oplus \\ V_{(0)}\{-3n + 2\} \end{matrix}$$

given by

$$c'_0 = \begin{bmatrix} 0 & 0 \\ 1 & 0 \end{bmatrix},$$

where we have used that the graded  $\mathfrak{sl}_2$ -module  $\text{SKh}^{-n+1}(T_{2,-(n-1)})\{-1\}$  is isomorphic to  $V_{(0)}\{-3n + 4\} \oplus V_{(0)}\{-3n + 2\}$  by induction.

To prove Lemma 15, we need the following claim.

<sup>9</sup> The diagram  $T_{2,-n;0}$  does not inherit a consistent orientation from  $T_{2,-n}$ . One therefore has to choose an orientation for  $T_{2,-n;0}$  ‘by hand’.



CLAIM 1. For  $n > 1$ , the isomorphism

$$\phi: \text{SKh}(\text{trivial unknot}) \longrightarrow \text{SKh}(T_{2,-n;0})$$

induced by a sequence of  $n - 1$  consecutive Reidemeister I moves is given by

$$\begin{aligned} \phi(w_+) &= \sum_{\ell=1}^n (-1)^{\ell+1} w_-^{\otimes(\ell-1)} \otimes w_+ \otimes w_-^{\otimes(n-\ell)}, \\ \phi(w_-) &= w_-^{\otimes n}, \end{aligned}$$

where the terms on the right-hand side live in the vector space associated to the all-0-resolution of  $T_{2,-n;0}$ . (Here we assume that the order of the tensor factors corresponds to the order in which the circles of the all-0-resolution appear as one travels around the annulus.)

The proof of the claim is an easy computation and therefore omitted.

*Proof of Lemma 15.* Since  $\text{SKh}(\text{trivial unknot})$  is supported in homological degree 0, it is clear that  $c_{i+n}$  is zero unless  $i + n = 0$ . By observing that  $c_0$  is induced by the chain map

$$g: C(T_{2,-n;0})\{-3n + 1\}[-n] \longrightarrow C(T_{2,-n;1})\{-1\}[-1]$$

that appears in the mapping cone description of  $C(T_{2,-n})$ , it is further easy to see that  $c_0$  can be written as

$$c_0 = (M \circ \phi)_*,$$

where  $\phi$  is as in the claim, and  $M$  is the map

$$C^0(T_{2,-n;0})\{-3n + 1\} = W^{\otimes n}\{-2n\} \xrightarrow{M} W^{\otimes(n-1)}\{-2n + 1\} = C^{-n+1}(T_{2,-(n-1)})\{-1\}$$

given by  $M(w_1 \otimes w_2 \otimes \cdots \otimes w_{n-1} \otimes w_n) := m(w_1 \otimes w_n) \otimes w_2 \otimes \cdots \otimes w_{n-1}$ , with  $m$  denoting Khovanov’s multiplication map. We thus obtain  $c_0([w_-]) = [M(\phi(w_-))] = 0$  and

$$c_0([w_+]) = [M(\phi(w_+))] = \begin{cases} 0 & \text{if } n \text{ is even,} \\ [2w_-^{\otimes(n-1)}] & \text{if } n \text{ is odd.} \end{cases}$$

Now observe that  $2w_-^{\otimes(n-1)} \in C^{-n+1}(T_{2,-(n-1)})\{-1\}$  cannot be a boundary because it sits in lowest possible homological degree. Hence,  $c_0([w_+])$  is non-zero whenever  $n$  is odd and, by looking at the gradings, one can see that  $c_0([w_+])$  lives in  $V_{(0)}\{-3n + 2\} \subset \text{SKh}^{-n+1}(T_{2,-(n-1)})\{-1\}$ . It is now evident that  $c_0$  has the desired form.  $\square$

The inductive step in the proof of Proposition 15 now follows from Lemma 15 and from the long exact sequence stated before Lemma 15.

The action of  $v_{-2}$  is now an easy computation, which is left to the reader.  $\square$

*Remark 13.* Comparing Proposition 15 to the computations in [Kho00, §6], we see that the ranks of  $\text{SKh}(T_{2,-n})$  and  $\text{Kh}(T_{2,-n})$  agree in all homological degrees except degrees 0 and 1.

*Remark 14.* As pointed out to us by one of the referees, a much shorter proof of Proposition 15 can be given by using the fact that the Bar-Natan complex associated to an annular braid closure has a particularly simple representative in its homotopy class. For this we refer to [MN08, Theorem 6.2], which is stated for  $\mathfrak{sl}_3$  link homology but which also should describe the Bar-Natan complex in the  $\mathfrak{sl}_2$  case without change. Starting from this explicit representative, the computation of the annular Khovanov homology is significantly easier than starting from  $C(T_{2,-n})$ , as we have done above.

## ACKNOWLEDGEMENTS

The authors would like to thank John Baldwin, Jack Hall, Hannah Keese, Aaron Lauda, Scott Morrison, Hoel Queffelec, Peter Samuelson, Alistair Savage, and David Treumann for interesting discussions. The authors would also like to thank Mikhail Khovanov, who originally proposed the idea of using maps induced by Reidemeister moves to define an  $\mathfrak{S}_n$  action on the Khovanov homology of  $n$ -cables of knots, and two anonymous referees for a number of helpful comments and corrections to an earlier draft of this paper.

## Appendix

In the following, let  $\mathbf{z} = \{(0, 0, z) \mid z \in \mathbb{R}\} \subset \mathbb{R}^3$  denote the  $z$ -axis in  $\mathbb{R}^3$ , and  $I = [0, 1]$ .

DEFINITION A.1. An (oriented) *annular link cobordism*  $\Sigma$  between (oriented) links  $L_0 \subset \mathbb{R}^3 \setminus \mathbf{z} = (\mathbb{R}^3 \setminus \mathbf{z}) \times \{0\}$  and  $L_1 \subset (\mathbb{R}^3 \setminus \mathbf{z}) = (\mathbb{R}^3 \setminus \mathbf{z}) \times \{1\}$  is a smooth, compact (oriented) surface embedded in  $(\mathbb{R}^3 \setminus \mathbf{z}) \times I$  satisfying:

- $\partial\Sigma = L_0 \amalg L_1$ ; and
- there exists some  $\epsilon > 0$  such that the intersection of  $\Sigma$  with  $(\mathbb{R}^3 \setminus \mathbf{z}) \times ([0, \epsilon] \amalg [1 - \epsilon, 1])$  can be identified with the product embedding  $(L_0 \times [0, \epsilon]) \amalg (L_1 \times [1 - \epsilon, 1])$ .

An annular link cobordism  $\Sigma$  is said to be *generic* if the projection map  $p : (\mathbb{R}^3 \setminus \mathbf{z}) \times I \rightarrow I$  restricted to  $\Sigma$  is Morse with distinct critical values.

DEFINITION A.2. An *annular movie* of a link cobordism is a smooth, one-parameter family of curves,  $D_t \subset (\mathbb{R}^2 \setminus \mathbf{0})$ ,  $t \in [0, 1]$ , called *annular stills*, satisfying:

- for all but finitely many  $t \in [0, 1]$ ,  $D_t$  is a link diagram;
- at each of the finitely many *critical levels*  $t_1, \dots, t_k$ , the diagram undergoes a single *elementary string interaction* (i.e., a birth, saddle, death, or Reidemeister move) localized to a disk in  $\mathbb{R}^2 \setminus \mathbf{0}$ .

Remark A.1. Since annular cobordisms are assumed compact, we can (and shall) consider all annular cobordisms to be embedded in  $(A \times I) \times I \subset (\mathbb{R}^3 \setminus \mathbf{z}) \times I$ . Accordingly, an annular movie may be viewed upon  $A \subset \mathbb{R}^2 \setminus \mathbf{0}$ .

LEMMA A.1. *Any annular link cobordism  $\Sigma$  can be represented by an annular movie.*

*Proof.* Let  $\Sigma$  be an annular link cobordism. Composing with the inclusion  $(\mathbb{R}^3 \setminus \mathbf{z}) \rightarrow \mathbb{R}^3$  produces a traditional link cobordism (cf. [Jac04, Definition 5]), which can be perturbed in a small open neighborhood (hence, in the complement of  $\mathbf{z} \times I$ ) to a generic (annular) link cobordism. The image of  $\Sigma$  under the projection map,

$$\pi \times \text{id} : \mathbb{R}^3_{(x,y,z)} \times I \rightarrow \mathbb{R}^2_{(x,y)} \times I,$$

is then an *annular broken surface diagram*, an immersed surface in  $(\mathbb{R}^2 \setminus \mathbf{0}) \times I$  whose points of self-intersection are generic double points, triple points, or branch points (cf. [CKS04, §1.4]). After a possible further perturbation of  $\Sigma$  (which can, again, be performed in the complement of  $\mathbf{z} \times I$ ), the intersections of the annular broken surface diagram with the level sets  $(\mathbb{R}^2 \setminus \mathbf{0}) \times \{t\}$  yield an annular movie of the link cobordism, as desired.  $\square$

LEMMA A.2. *Let  $\Sigma$  be an annular link cobordism represented by two different annular movies  $\mathbf{M}_\Sigma$  and  $\mathbf{M}'_\Sigma$ . Then  $\mathbf{M}_\Sigma$  and  $\mathbf{M}'_\Sigma$  are related by a finite sequence of Carter–Saito movie moves (see [CS93, Figures 23–37]), each of which is localized to a disk in  $\mathbb{R}^2 \setminus \mathbf{0}$ .*

*Proof.* As before,  $\Sigma \subseteq (\mathbb{R}^3 \setminus \mathbf{z}) \times I \subseteq \mathbb{R}^3 \times I$  can be viewed as a traditional link cobordism, and the isotopy joining the representatives of  $\Sigma$  giving rise to  $\mathbf{M}_\Sigma$  and  $\mathbf{M}'_\Sigma$ , respectively, can be viewed as an isotopy in  $\mathbb{R}^3 \times I$ . Carter–Saito’s movie move theorem [CS93, Theorem 7.1] then implies that there exists some finite sequence of movie moves, each localized to a disk in  $\mathbb{R}^2$ , relating  $\mathbf{M}$  and  $\mathbf{M}'$ .

We claim that each movie move can, in fact, be localized to a disk in  $\mathbb{R}^2 \setminus \mathbf{0}$ . But this follows because if any of the movie moves is localized to a disk which cannot be made disjoint from  $\mathbf{0}$ , then in the course of the movie move, there exists some still whose curve intersects  $\mathbf{0}$ . The corresponding cobordism it represents must therefore intersect  $\mathbf{z} \times I$ , which is a contradiction.  $\square$

## REFERENCES

- APS04 M. M. Asaeda, J. H. Przytycki and A. S. Sikora, *Categorification of the Kauffman bracket skein module of  $I$ -bundles over surfaces*, *Algebr. Geom. Topol.* **4** (2004), 1177–1210 (electronic).
- AGW14 D. Auroux, J. E. Grigsby and S. M. Wehrli, *Khovanov–Seidel quiver algebras and bordered Floer homology*, *Selecta Math. (N.S.)* **20** (2014), 1–55.
- AGW15 D. Auroux, J. E. Grigsby and S. M. Wehrli, *Sutured Khovanov homology, Hochschild homology, and the Ozsváth–Szabó spectral sequence*, *Trans. Amer. Math. Soc.* **367** (2015), 7103–7131.
- BG15 J. A. Baldwin and J. E. Grigsby, *Categorified invariants and the braid group*, *Proc. Amer. Math. Soc.* **143** (2015), 2801–2814.
- Bar05 D. Bar-Natan, *Khovanov’s homology for tangles and cobordisms*, *Geom. Topol.* **9** (2005), 1443–1499 (electronic).
- BHLZ17 A. Beliakova, K. Habiro, A. D. Lauda and M. Živković, *Trace decategorification of categorified quantum  $\mathfrak{sl}(2)$* , *Math. Ann.* **367** (2017), 397–440.
- BPW16 A. Beliakova, K. Putyra and S. M. Wehrli, *Quantum link homology via trace functor  $I$* , Preprint (2016), [arXiv:1605.03523](https://arxiv.org/abs/1605.03523).
- Ber90 J. Bernstein, *Trace in categories*, in *Operator algebras, unitary representations, enveloping algebras, and invariant theory (Paris, 1989)*, *Progress in Mathematics*, vol. 92 (Birkhäuser, Boston, MA, 1990), 417–423.
- BS11 J. Brundan and C. Stroppel, *Highest weight categories arising from Khovanov’s diagram algebra I: cellularity*, *Mosc. Math. J.* **11** (2011), 685–722.
- CKS04 J. S. Carter, S. Kamada and M. Saito, *Surfaces in 4-space*, in *Low-dimensional topology, III*, *Encyclopaedia of Mathematical Sciences*, vol. 142 (Springer, Berlin, 2004).
- CS93 J. S. Carter and M. Saito, *Reidemeister moves for surface isotopies and their interpretation as moves to movies*, *J. Knot Theory Ramifications* **2** (1993), 251–284.
- CK08 S. Cautis and J. Kamnitzer, *Knot homology via derived categories of coherent sheaves. I. The  $\mathfrak{sl}(2)$ -case*, *Duke Math. J.* **142** (2008), 511–588.
- CK14 Y. Chen and M. Khovanov, *An invariant of tangle cobordisms via subquotients of arc rings*, *Fund. Math.* **225** (2014), 23–44.
- CMW09 D. Clark, S. Morrison and K. Walker, *Fixing the functoriality of Khovanov homology*, *Geom. Topol.* **13** (2009), 1499–1582.
- GM17 J. Greenstein and V. Mazorchuk, *Koszul duality for semidirect products and generalized Takiff algebras*, *Algebr. Represent. Theory* **20** (2017), 675–694.

- GN14 J. E. Grigsby and Y. Ni, *Sutured Khovanov homology distinguishes braids from other tangles*, Math. Res. Lett. **21** (2014), 1263–1275.
- GW10a J. E. Grigsby and S. M. Wehrli, *Khovanov homology, sutured Floer homology and annular links*, Algebr. Geom. Topol. **10** (2010), 2009–2039.
- GW10b J. E. Grigsby and S. M. Wehrli, *On the colored Jones polynomial, sutured Floer homology, and knot Floer homology*, Adv. Math. **223** (2010), 2114–2165.
- GW11 J. E. Grigsby and S. M. Wehrli, *On gradings in Khovanov homology and sutured Floer homology*, in *Topology and geometry in dimension three*, Contemporary Mathematics, vol. 560 (American Mathematical Society, Providence, RI, 2011), 111–128.
- HN13 M. Hedden and Y. Ni, *Khovanov module and the detection of unlinks*, Geom. Topol. **17** (2013), 3027–3076.
- HK01 R. S. Huerfano and M. Khovanov, *A category for the adjoint representation*, J. Algebra **246** (2001), 514–542.
- HKLM15 H. Hunt, H. Keese, A. M. Licata and S. Morrison, *Computing annular Khovanov homology*, Preprint (2015), [arXiv:1505.04484](https://arxiv.org/abs/1505.04484).
- Jac04 M. Jacobsson, *An invariant of link cobordisms from Khovanov homology*, Algebr. Geom. Topol. **4** (2004), 1211–1251 (electronic).
- Juh06 A. Juhász, *Holomorphic discs and sutured manifolds*, Algebr. Geom. Topol. **6** (2006), 1429–1457 (electronic).
- Kho00 M. Khovanov, *A categorification of the Jones polynomial*, Duke Math. J. **101** (2000), 359–426.
- Kho03 M. Khovanov, *Patterns in knot cohomology. I*, Experiment. Math. **12** (2003), 365–374.
- Kho05 M. Khovanov, *Categorifications of the colored Jones polynomial*, J. Knot Theory Ramifications **14** (2005), 111–130.
- KR08 M. Khovanov and L. Rozansky, *Matrix factorizations and link homology*, Fund. Math. **199** (2008), 1–91.
- Lau10 A. D. Lauda, *A categorification of quantum  $\mathfrak{sl}(2)$* , Adv. Math. **225** (2010), 3327–3424.
- Lee05 E. S. Lee, *An endomorphism of the Khovanov invariant*, Adv. Math. **197** (2005), 554–586.
- Lou72 M. Loupias, *Représentations indécomposables de dimension finie des algèbres de Lie*, Manuscripta Math. **6** (1972), 365–379.
- MN08 S. Morrison and A. Nieh, *On Khovanov’s cobordism theory for  $\mathfrak{su}_3$  knot homology*, J. Knot Theory Ramifications **17** (2008), 1121–1173.
- OS05 P. Ozsváth and Z. Szabó, *On the Heegaard Floer homology of branched double-covers*, Adv. Math. **194** (2005), 1–33.
- Pla06 O. Plamenevskaya, *Transverse knots and Khovanov homology*, Math. Res. Lett. **13** (2006), 571–586.
- PS00 J. H. Przytycki and A. S. Sikora, *On skein algebras and  $\mathrm{Sl}_2(\mathbb{C})$ -character varieties*, Topology **39** (2000), 115–148.
- QR15 H. Queffelec and D. E. V. Rose, *Sutured annular Khovanov–Rozansky homology*, Trans. Amer. Math. Soc., to appear. Preprint (2015), [arXiv:1506.08188](https://arxiv.org/abs/1506.08188).
- Ras05 J. Rasmussen, *Khovanov’s invariant for closed surfaces*, Preprint (2015), [arXiv:math/0502527](https://arxiv.org/abs/math/0502527) [math.GT].
- Ras10 J. Rasmussen, *Khovanov homology and the slice genus*, Invent. Math. **182** (2010), 419–447.
- Rob13 L. P. Roberts, *On knot Floer homology in double branched covers*, Geom. Topol. **17** (2013), 413–467.
- SS06 P. Seidel and I. Smith, *A link invariant from the symplectic geometry of nilpotent slices*, Duke Math. J. **134** (2006), 453–514.

- Str05 C. Stroppel, *Categorification of the Temperley–Lieb category, tangles, and cobordisms via projective functors*, *Duke Math. J.* **126** (2005), 547–596.
- Sus07 J. Sussan, *Category  $O$  and  $\mathfrak{sl}(k)$  link invariants*, PhD thesis, Yale University, ProQuest LLC, Ann Arbor, MI (2007).
- TV14 N. Tsilevich and A. Vershik, *On a relation between the basic representation of the affine Lie algebra  $\mathfrak{sl}(2)$  and a Schur–Weyl representation of the infinite symmetric group*, Preprint (2014), [arXiv:1403.1558](https://arxiv.org/abs/1403.1558).
- Web16 B. Webster, *Tensor product algebras, Grassmannians and Khovanov homology*, in *Physics and mathematics of link homology*, Contemporary Mathematics, vol. 680 (American Mathematical Society, Providence, RI, 2016), 23–58.

J. Elisenda Grigsby [grigsbyj@bc.edu](mailto:grigsbyj@bc.edu)

Boston College, Department of Mathematics, 5th floor Maloney, Chestnut Hill, MA 02467, USA

Anthony M. Licata [anthony.licata@anu.edu.au](mailto:anthony.licata@anu.edu.au)

Mathematical Sciences Institute, Australian National University, Canberra, Australia

Stephan M. Wehrli [smwehrli@syr.edu](mailto:smwehrli@syr.edu)

Syracuse University, Department of Mathematics, 215 Carnegie, Syracuse, NY 13244, USA