

A Case of Familial Chromosomal Aberration with G Group Mosaic

L. Gedda, G. Torrioli-Riggio, L. Romei, A. Alfieri, F. Calabresi
G. Del Porto, R. Gentile

Introduction

The literature on familial mosaicism shows very few available data: as far as we know, two cases have been published in 1964, and one in 1965.

The first observation (Borges *et al.*, 1964) concerned a mosaic 45/46 with F monosomy in the aneuploid clone. The anomaly was carried by two young brothers and their maternal grandmother.

The second case (Kiosoglou *et al.*, 1964) was a mongol child with acute granulocytic leukemia showing 12 different karyotypic clones. The sister, the mother and the maternal grandmother all showed mosaicism.

In 1965, Zellweger and Abbe have studied the family of a girl with mongoloid characteristics and multiple mosaicism. The brother, clinically normal, had a XO/XY mosaic; the father and the paternal grandmother, normal in appearance, both had mosaicism, formed by a numerically rich clone of normal cells and by cells showing a balanced translocation D/D.

The fact that so few observations of familial mosaicism be found in the literature might lead us to think that we are confronted with an exceptional event. Nevertheless, we believe that the scarcity of observations may be due both to the detection difficulties and to the small number of aneuploid cells often found in the examined case. In the present case and in different mongol sibships, we observed (Chicago, 1966) that aberrant clones may be present also in perfectly normal individuals. It is the presence of an aneuploid individual, that leads us to the research of abnormal karyotypes in the family. Often, only one or two tissues and few chromosome plates are examined. Furthermore, if no aneuploid individual is found, no one asks for a karyotypic examination even if a woman has had plenty of unexplained miscarriages. In a recent work (Pawlowitzki, 1966) the percentage of aneuploid fetuses in human abortions, has been calculated around 3.5%.

¹ Paper read at the VI International Congress of Pathology (Rome, October 3-8, 1966).

Clinical case

The index case is a boy aged 8, born from normal delivery; at birth, his weight was 4000 g, and he showed six fingers on the left hand. The sixth finger being only a cutaneous appendix, it was cut off after a few days. The right hand had only four fingers. Later on, parents noticed an underdevelopment of external sex organs, and for this reason he was brought to our examination.

From the whole physical, radiological and laboratory examination, we shall only report positive findings.

Malformations of the hands were corroborated by radiographical examination; peno-scrotal hypospadias, uncinated penis and punctiform meatus were evident at physical examination.

Neurologic examination showed decreased tonus and muscular strength, sluggish deep reflexes evident especially for the achilleus, in the inferior left limb.

Ophthalmologic examination revealed small congenital opacities of lens in both eyes.

Sex chromatin was male in type.

DERMATOGLYPHICS

Fingers: Clear creases and well-shaped figures. Absence of R-IV.

R: Lu/14. W/18. S/12. —. W/27 - RFRC = 71

L: Lu/16. S/11. W/17. S/24. W/18 - LFRC = 86

TFRC = 157

Palms: Clear creases and figures. The determination is uneasy, because of the hand malformations. Digital triradii are present and in normal position. Inter-digital figures. Atd angle: *R* 52°, *L* 62°.

FAMILY HISTORY

The boy is the first born of a sibship of four.

The second born was a girl who died three days after birth; she had six fingers on both hands and feet, and anal atresia.

The third pregnancy ended in abortion at the third month.

The fourth born is a girl, now aged four, who is phenotypically normal.

The fifth born was a girl, who lived only seventeen days; she had four normal fingers and a rudiment of a fifth one on the right hand; the left hand had three para-normal fingers and skin syndactily of fingers III and IV; the toes were normal in number but misshapen; she also showed anal atresia, like her dead sister, and cleft palate.

As no post-mortem examination was performed on either one of the two dead children, we do not know if malformations of internal organs were present. Karyotypes were not made.

Tab. 1. Chromosomal analysis of the P. family

Subject	Mosaicism	N. of clones	N. of chromosomal elements	Karyotypes	Plates studied		Total
					%	N.	
Propositus P. Antonio	+	3	45	monosomy A	9.2	5	54
			46	normal	46.4	25	
			47	trisomy A	18.6	10	
			other cells	25.8	14		
Sister P. Maddalena	+	3	45	monosomy A	7.6	3	39
			46	normal	64.3	25	
			47	trisomy A	23.0	9	
			other cells	5.1	2		
Father P. Giuseppe	+	2	45	normal	75.3	33	44
			46	trisomy A			
			other cells	15.7	7		
Mother P. Antonietta	+	2	45	monosomy A	36.6	19	52
			46	normal	40.5	21	
			other cells	22.9	12		

Parents are both phenotypically normal with the exception of a reduced I.Q. in the father. They are not consanguineous, but they both come from an ethnic isolate of about 2000 inhabitants in the Calabrian hills.

No pathologic data in the ancestors result from a close interrogation of parents.

CHROMOSOMES

To all four members of the family, blood was drawn for routine karyotypical analysis. They refused examination of other tissues.

As can be clearly seen from Tab. 1 and Figs. 2-6, the propositus and his sister show three clones of cells: 45/monosomy A, 46/normal, 47/trisomy A.

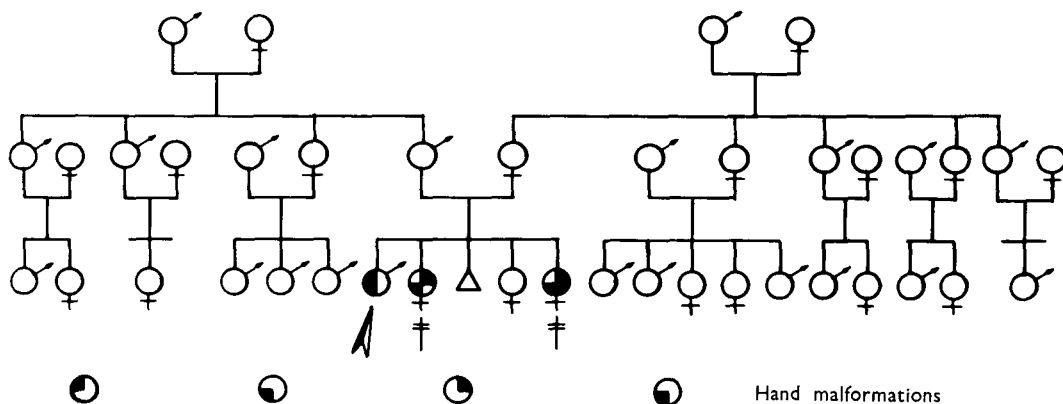

Fig. 1. Pedigree of the P. family

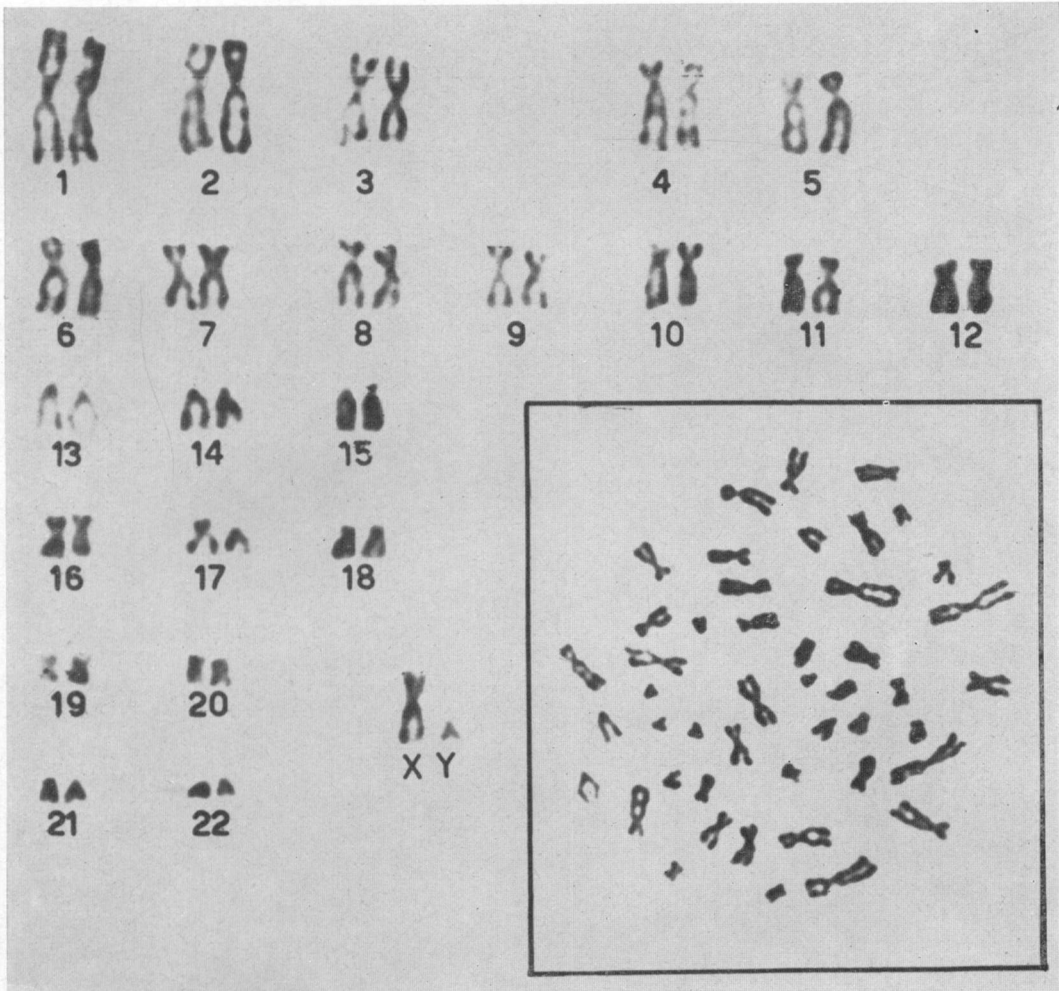

Fig. 2. Antonio. Karyotype of the normal clone

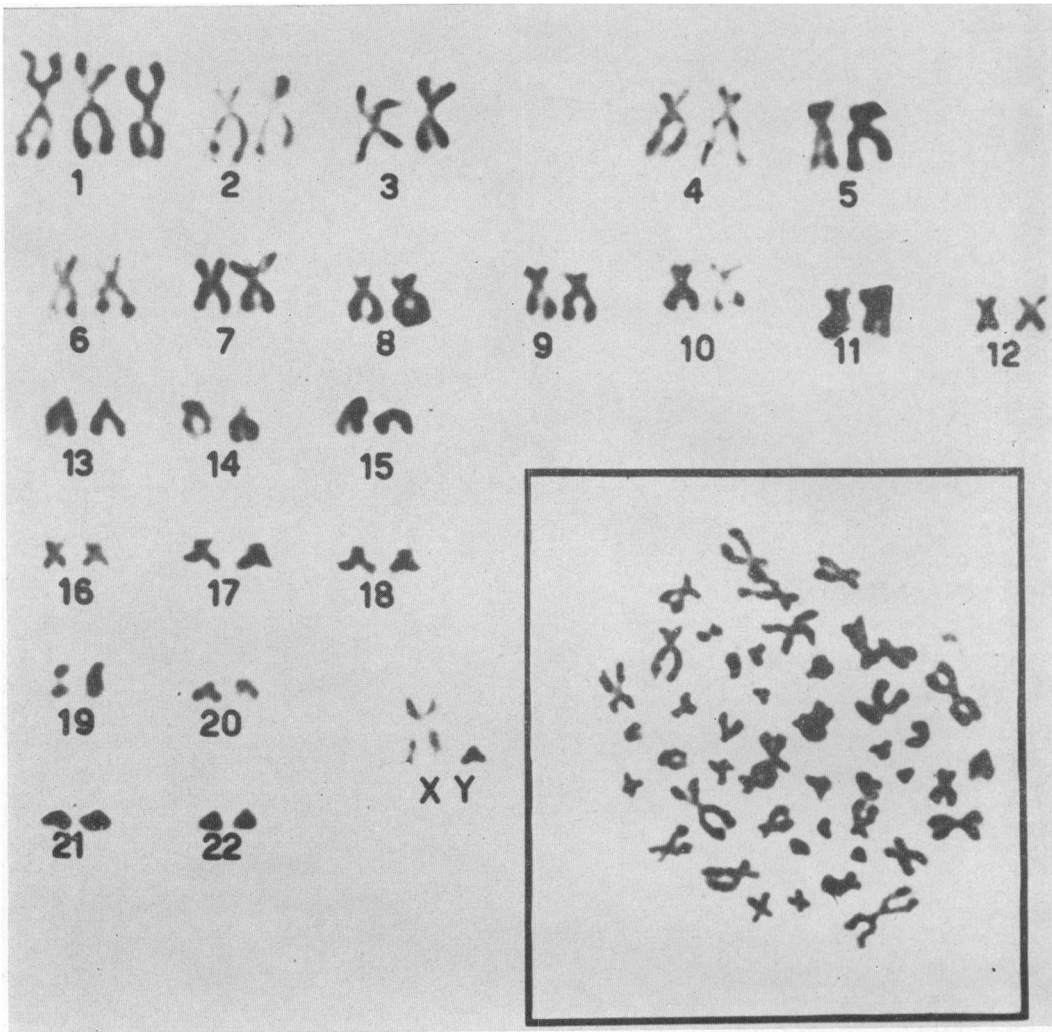

Fig. 3. Antonio. Karyotype of the aneuploid clone 47/trisomy A

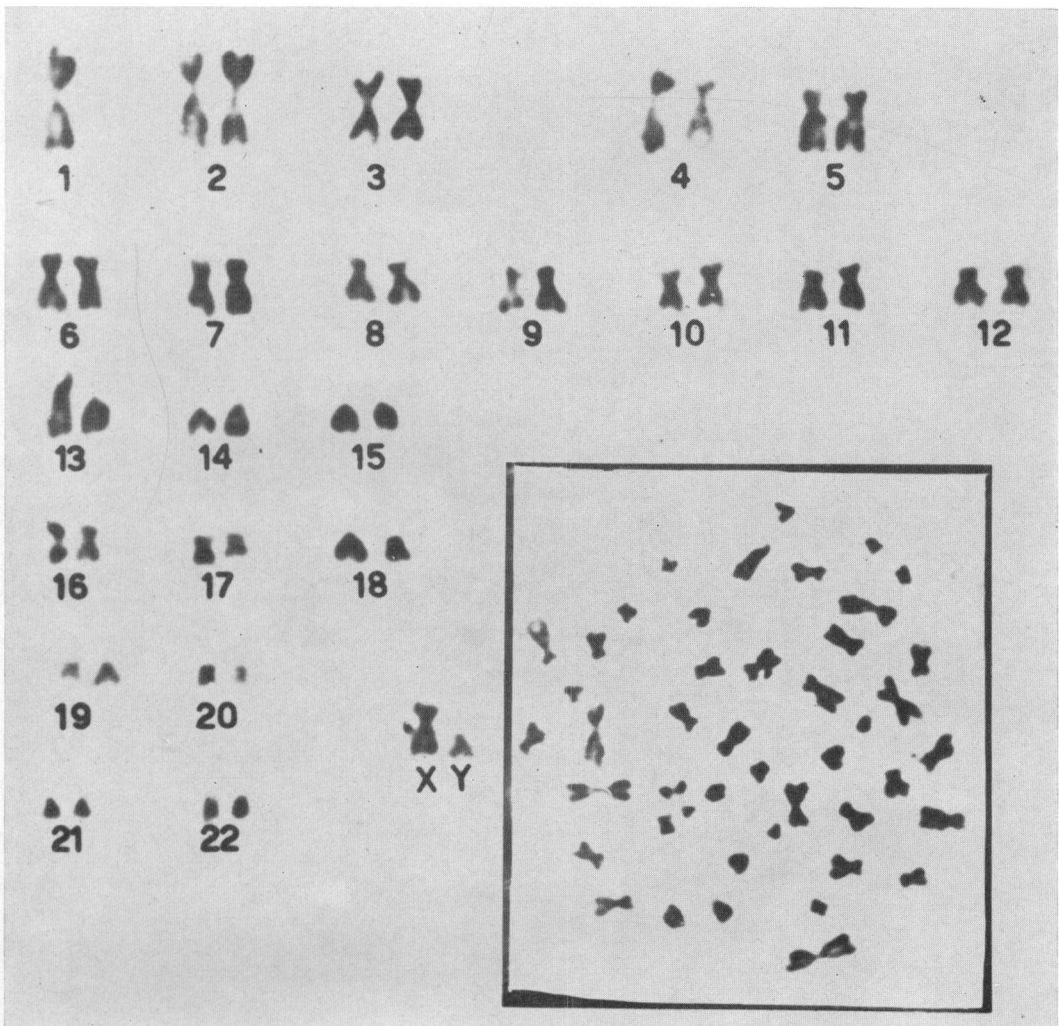

Fig. 4. Antonio. Karyotype of the aneuploid clone 45/monosomy A

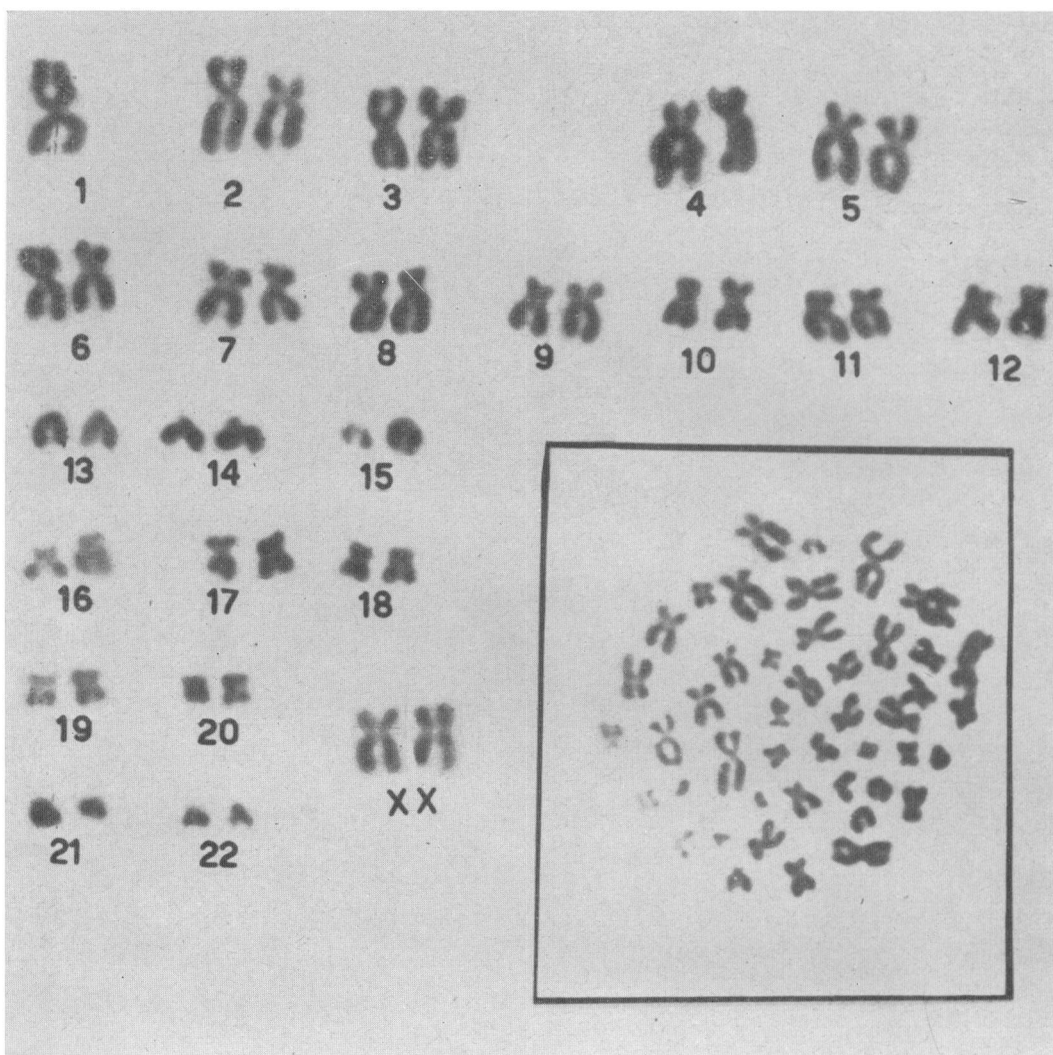

Fig. 5. Maddalena. Karyotype of the aneuploid clone 45/monosomy A

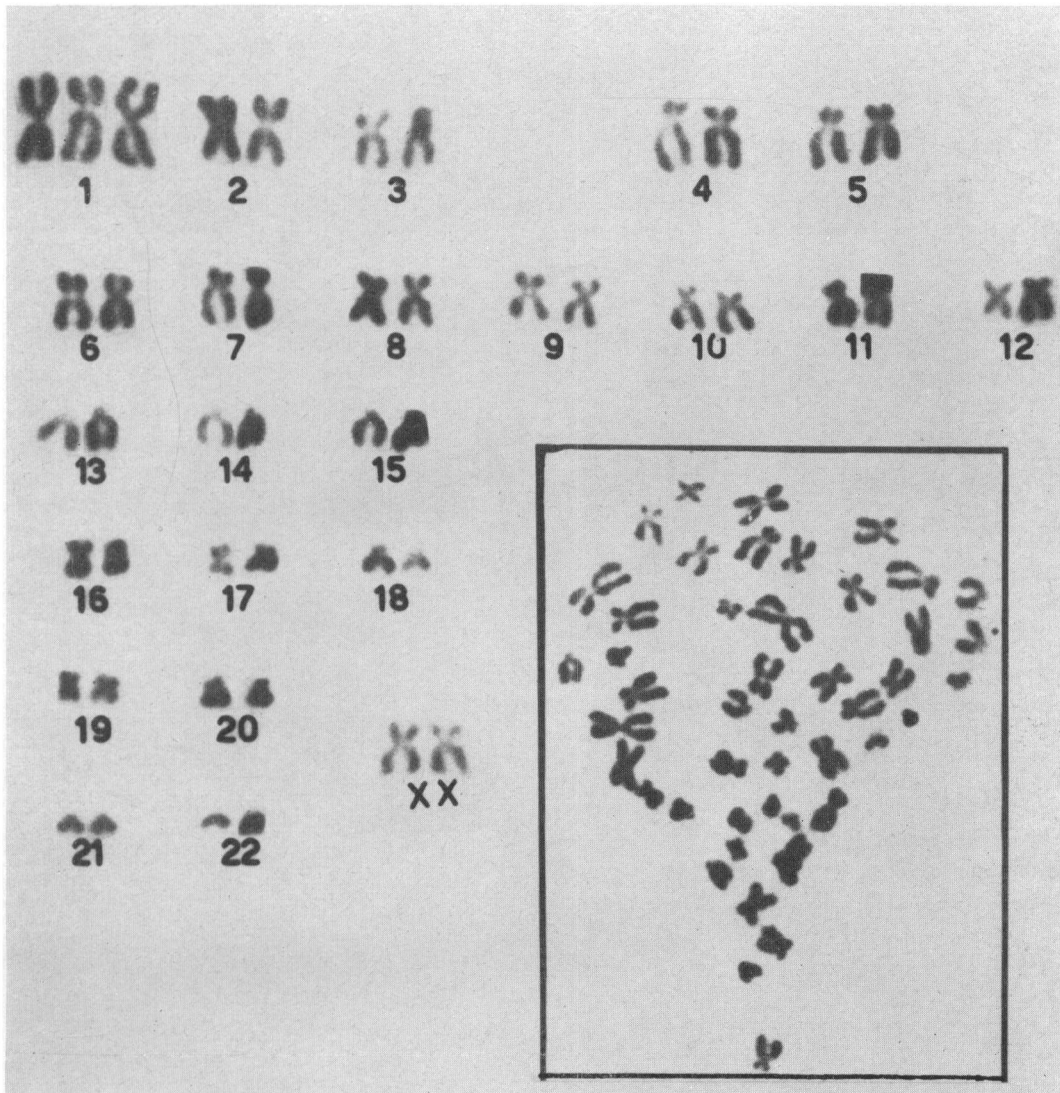

Fig. 6. Maddalena. Karyotype of the aneuploid clone 47/trisomy A

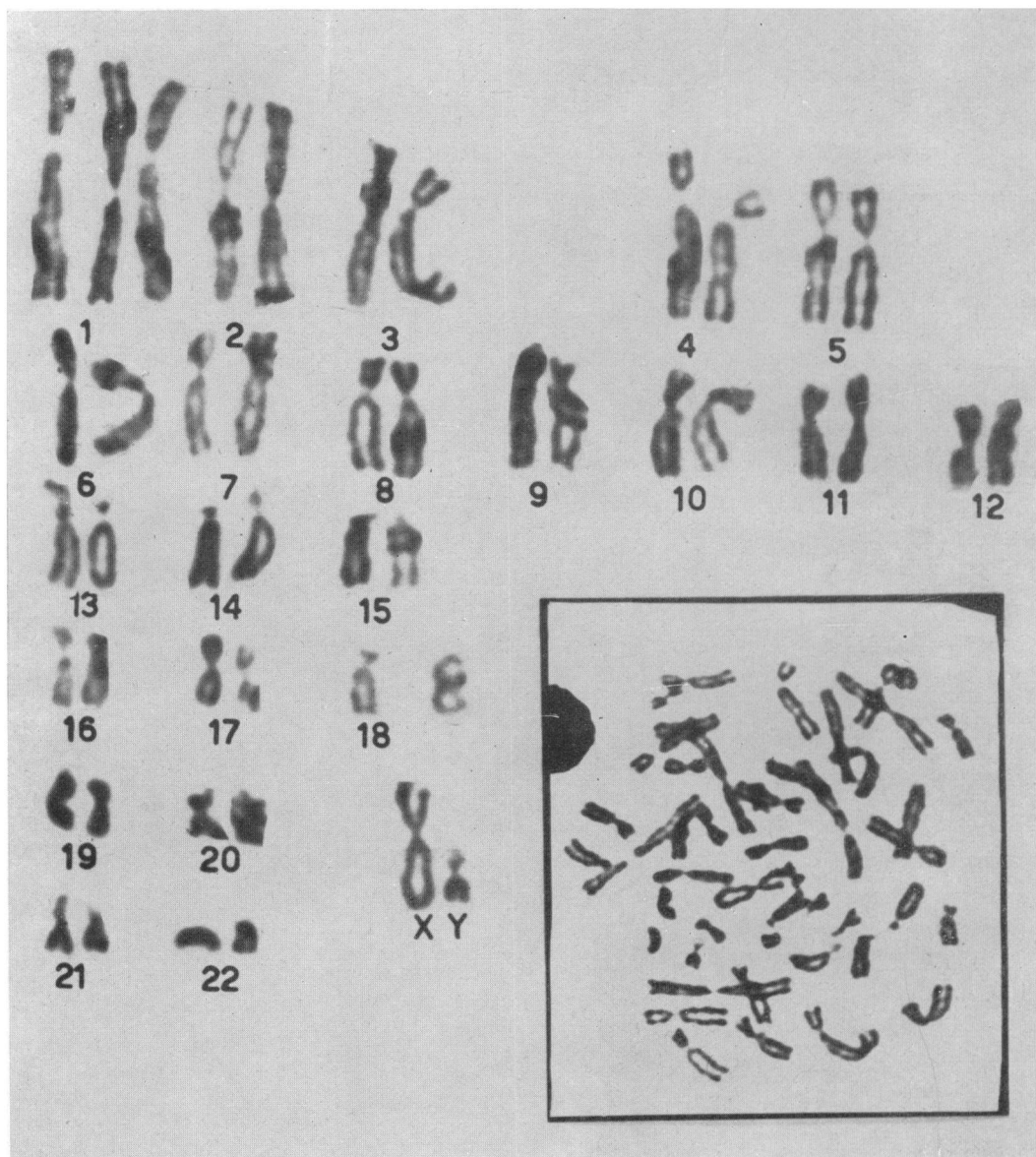

Fig. 7. Giuseppe. Karyotype of the aneuploid clone 47/trisomy A also showing other malformations

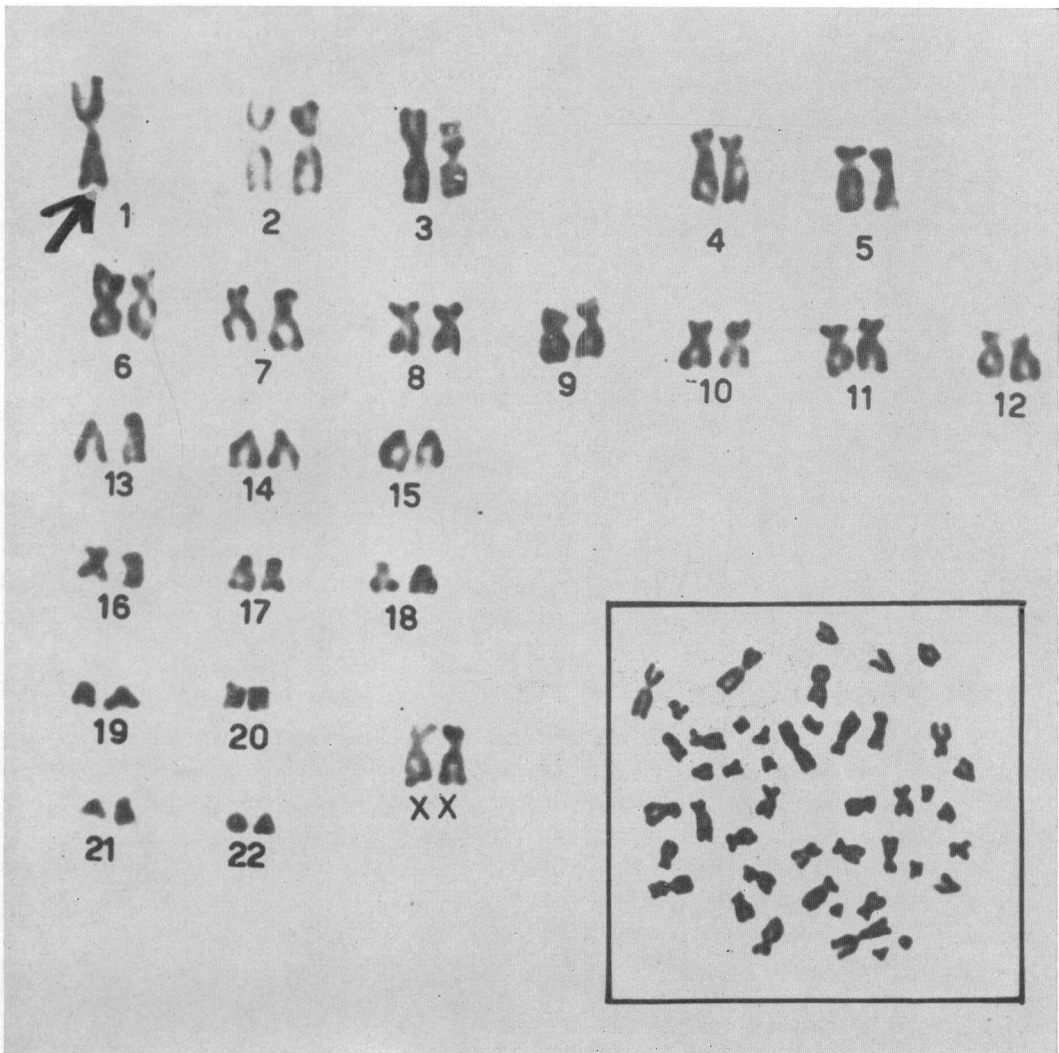

Fig. 8. Antonietta. Karyotype of the aneuploid clone 45/monosomy A

The father has only two clones: 46 normal and 47 trisomy A (Fig. 7). The mother has also two clones: 46 normal and 45 monosomy A (Fig. 8).

Besides the aneuploid clones, they all had some minus – and plus – variants of chromosomal number in the same proportion, as can be found in normal karyotype plates. Other cells with abnormal chromosomes have been found, but as the abnormality did not constantly regard the same chromosome, they could not be considered as clones, and are grouped in Tab. 1 as “other cells”.

Discussion

Rather than discuss, we shall try to hypothesize some answers to a series of questions that arise from our observation:

1. Are the propositus' malformations to be ascribed to the aneuploid mosaic? As far as we know, only four cases of group A chromosomal aberrations are reported: three cases of trisomy and one of monosomy. All have been found in human foetuses from early miscarriages. Presumably, a total or a prevailing aneuploidia concerning chromosome 1 has a lethal effect. In the family observed by us, we find an abortion and two girls who died soon after birth showing almost the same abnormalities present in the propositus to a lesser degree. It seems therefore likely that the propositus' malformations may be due to the mosaicism, inherited as a dominant autosomal trait. The fact that the living sister and the parents do not show any malformation can be explained by the different expressivity due to the different percentage of aneuploid cells in the body.

2. Is it possible to inherit a mosaic? Up to date, the formation of a mosaic can be attributed to a translocation, to a non-disjunction, or, in any case, to a more or less early disorder of the zygote during mitosis. Such a pathogenesis cannot explain in every case the familiarity of a mosaic. We believe that it is necessary to take into consideration the factors which act on mitosis itself. These factors, e.g. those underlying the formation and arrangement of spindle fibers, could be modified by a hereditary pathological phenomenon acting at the molecular level. Therefore, we agree with the hypothesis that “a genetically determined tendency to formation of various mosaicism exists in the family” (Zellweger & Abbo, 1965).

We do not entirely partake the same Authors' opinion that a single gene be responsible for the phenomenon. The other families reported in papers on this subject show different mosaics in different family members as if the gene would produce a general tendency to mosaicism without influencing a special chromosome. In our case, only one chromosome is involved. How can we explain with a single gene these two different types? A possible explanation might be provided by the theory suggested by Fergusson-Smith and Handmaker (1960), i.e. that the presence of satellites in some chromosomes would favour their non-disjunction and translocation. It is true that chromosomes with satellites show aberrations more frequently than the rest, and therefore this hypothesis is acceptable if we consider satellites as a favourable point for the localization of aneuploidia. Chromosome 1 usually has satellites, though in

our plates they are not evident; in this family, satellite alterations might have favoured the constant localization of the aberration on chromosome 1.

3. The parents show both aneuploidia of group A, but, whereas in one of them a trisomy is observed, the other shows monosomy. These differences could be due to the scarcity of plates examined; further chromosome cultures will permit us to clarify this point. The parents state that they are not consanguineous; but we believe that, being this such a rare anomaly of a dominant type, and living both individuals in a small isolate, it is very probable that a consanguinity exists, even if unknown to them.

Further research is being carried on, involving ancestors and relatives.

Summary

A familial mosaicism involving chromosomes of group A. The father shows two clones: 46/normal and 47/trisomy A; the mother, 46/normal and 45/monosomy A. The two children are three clone mosaics: 45/monosomy A, 46/normal, 47/trisomy A.

Only one of the children is phenotypically abnormal: the other three members of the family have a normal appearance.

Relationship between karyotype and malformations is discussed. A tentative explanation is suggested.

References

- BERGES W. H. *et al.* (1964). *J. Pediat.*, **65**: 103.
CARR D. H. (1965). *Obstet. Gynec.*, **26**: 308.
FERGUSON-SMITH M. A., HANDMAKER S. D. (1961). Observations on the satellited human chromosomes. *Lancet*, **2**: 1362.
HALL B., KÄLLÉN B. (1964). Chromosome studies in abortuses and stillborn infants. *Lancet*, **1**: 100.
KELLY S. *et al.* (1965). Autosomal monosomy in a spontaneous abortion. *Lancet*, **1**: 166.
KIOSSOGLOU K. A. *et al.* (1964). Multiple chromosomal aberrations in a patient with acute granulocytic leukemia associated with Down's syndrome and twinning. *Blood*, **24**: 134.
PAWLOWITZKI I. H. (1966). Chromosomenanomalie als Abortursache. *Deutsch. Med. Wochenschr.*, **91**: 1094.
ZELLWEGER H., ABBO G. (1965). Familial mosaicism attributable to a new gene. *Lancet*, **2**: 455.

RIASSUNTO

Mosaico familiare riguardante i cromosomi del gruppo A. Il padre presenta due cloni 46/normale e 47/trisomia A; la madre, 46/ normale e 45/monosomia A. I due figli presentano tre cloni a mosaico: 45/monosomia A, 46 normale, 47/trisomia A. Soltanto uno dei figli presenta anomalia fenotipiche, mentre gli altri tre membri della famiglia appaiono normali. Vengono discussi i rapporti fra cariotipo e malformazioni e viene proposta una possibile interpretazione.

RÉSUMÉ

Mosaïque familial concernant les chromosomes du groupe A. Le père présente deux clones: 46/normal et 47/trisomie A; la mère, 46/normal et 45/monosomie A. Les deux enfants présentent trois clones: 45/monosomie A, 46/normal, 47/trisomie A. Seulement l'un des enfants présente des altérations phénotypiques, tandis que les trois autres membres de la famille paraissent normaux. Les relations entre karyotypes et malformations sont discutées et une interprétation est proposée.

ZUSAMMENFASSUNG

Familienmosaik in Bezug auf die Chromosomen der Gruppe A. Beim Vater sind zwei Klone 46/normal und 47/Trisomie A, bei der Mutter 46/normal und 45/Monosomie vorhanden. Bei den beiden Kindern finden sich drei Mosaik-Klone, nämlich 45/Monosomie A, 46/normal und 47/Trisomie A. Nur bei einem der Kinder sind phänotypische Anomalien zu bemerken, während die übrigen drei Familienmitglieder normal aussehen. Es folgt eine Erörterung über die Beziehungen zwischen Missbildungen und Karyotyp und es wird eine eventuelle Interpretation dafür vorgeschlagen.