



YOUR OPTICAL
COATING PARTNER
**FOR SO MANY
REASONS**

REASON #9:

LIFE SCIENCES
AND FLUORESCENCE
FILTER CATALOG

www.alluxa.com
1-855-4ALLUXA



Expand your Knowledge
of Microscopy with

MSA Membership!

Whether your primary focus is in light, electron, or scanning probe microscopy, or the biological or physical sciences, MSA takes your knowledge to the next level!

Members Receive:

- A personal subscription to MSA's official journal, *Microscopy and Microanalysis*, and MSA's popular bi-monthly magazine, *Microscopy Today*
- Peer Networking through the Society's Focused Interest Groups and Local Affiliated Societies
- Discounts on books, journals, and other educational materials
- MSA Awards Programs, Speaker Opportunities, Scholarships, and much more!

For more information:
visit www.microscopy.org
or call 1-800-538-3672



Join MSA Today!

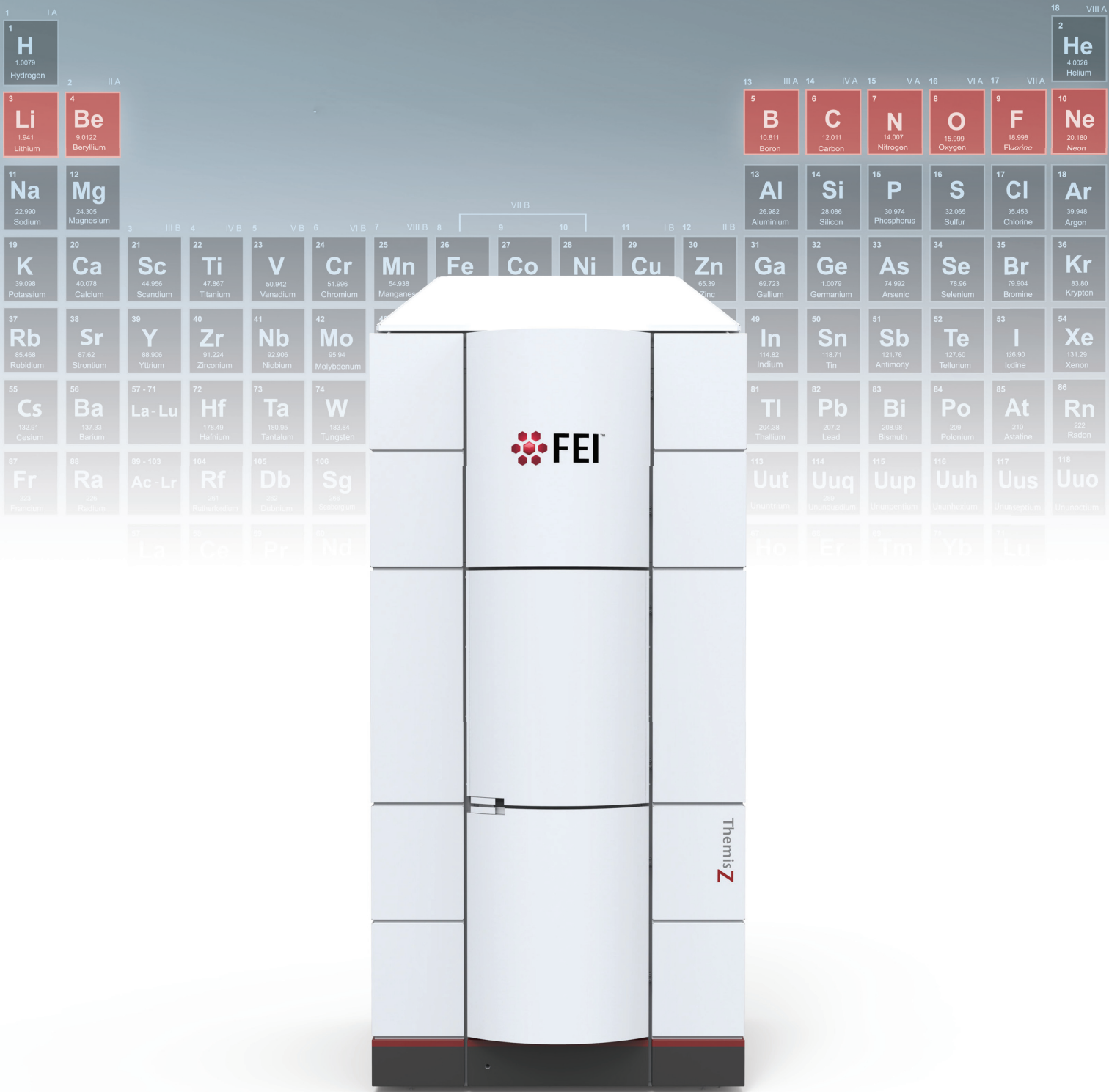

Think you've seen Themis? Meet Z.

We're making it easier to analyze low-Z, beam sensitive materials that are typically difficult to image in STEM mode. Discover how the FEI Themis Z can help you explore the widest range of materials across the periodic table.

Discover more at [FEI.com/Themis-Z](https://www.fei.com/themis-z)



the world's best cathodes...



APTech

Lanthanum and Cerium Hexaboride (LaB₆ and CeB₆) Filaments/Cathodes



Applied Physics Technologies has decades of experience in research, development, and manufacturing of LaB₆ and CeB₆ cathodes. At EMS, we are pleased to provide these cathodes for your replacement needs, OEM, and custom applications.

The unique properties of hexaboride crystals provide stable electron-emitting media with work functions near 2.65 eV. The low work function yields higher currents at lower cathode temperatures than tungsten, which means greater brightness (or current at the beam focus) and longer cathode life. Typically, these cathodes exhibit 10 times the brightness and more than 10 times the service life of tungsten cathodes. In electron microscope applications, these characteristics translate to more beam current in a smaller spot at the sample, improved resolution, and less frequent cathode replacement.

Applications

Small Spot Size

- SEM
- TEM
- Surface Analysis
- Metrology

High Current

- Microwave Tubes
- Lithography
- Electron-Beam Welders
- X-ray Sources
- Free Electron Lasers



...EMS has it!

CONTACT US FOR MORE INFORMATION...

**Electron
Microscopy
Sciences**

P.O. Box 550 • 1560 Industry Rd.
Hatfield, Pa 19440

Tel: (215) 412-8400 • Fax: (215) 412-8450

email: sgkcck@aol.com

or stacie@ems-secure.com

OUR MAIN INTERACTIVE WEBSITE:

www.emsdiasum.com



TO REQUEST A COPY
OF OUR CATALOG:

[www.emsdiasum.com/
requests/catalog](http://www.emsdiasum.com/requests/catalog)



TO VIEW OUR
DIGITAL CATALOG:

catalog.emsdiasum.com

Someone has to be first.
XFlash® FlatQUAD, multiple detector systems & VZ

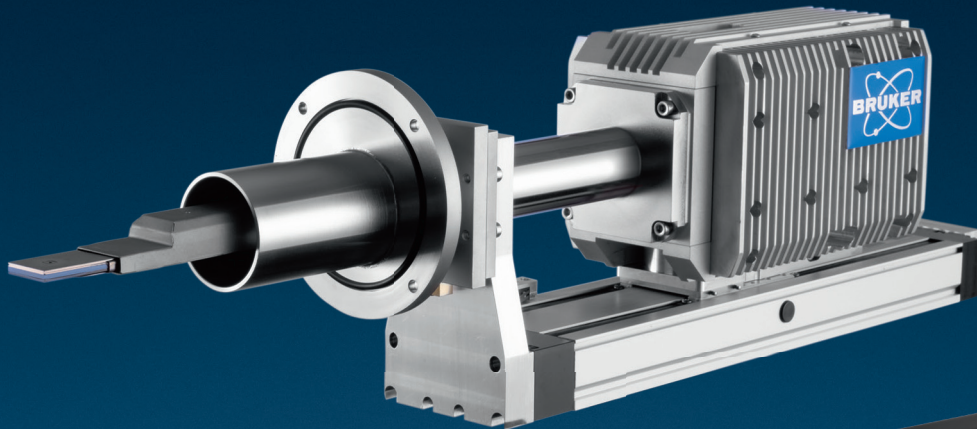

Analyze textured
samples with ease.



- The unique XFlash® FlatQUAD offers a large solid angle and an amazing take-off angle. This minimizes shadowing so you can see every nook and cranny of your sample in record time.
- Bruker's multiple detector systems provide large solid angles and great take-off angles too. You can start with one detector building up to four, depending on your needs.
- The Variable Z (VZ) adapter allows you to optimize take-off angles in-situ, which significantly improves the analysis of topographically challenging samples.

Someone has to be first.



www.bruker.com/quantax-flatquad

Innovation with Integrity

EDS

SIA

1 TO 50 MEGAPIXELS live and slow scan
MAGNIFICATION FACTOR OF 1 on bottom mounted cameras
DIFFRACTION BEAM STOP on side mounted cameras

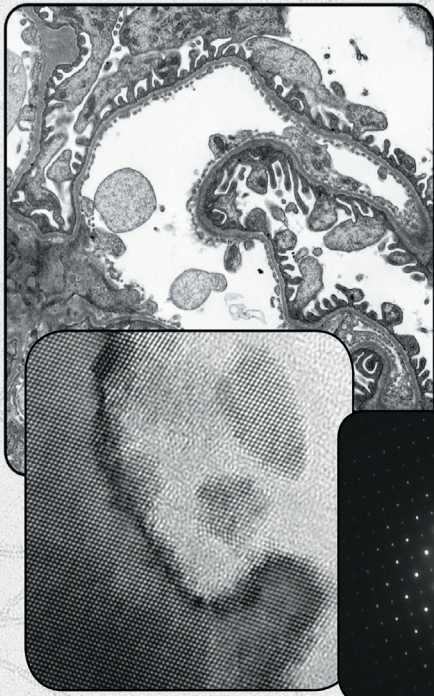

Affordable TEM camera systems for research, education, healthcare, and industry since 2001

Scientific Instruments and Applications
2773 Heath Lane • Duluth, GA 30096
(770) 232 7785 • www.sia-cam.com

M&M 2017 MICROSCOPY & MICROANALYSIS

August 6-10, 2017 • St. Louis, MO

Don't miss special anniversary programming in honor of

75 YEARS MSA
1942-2017 Microscopy Society of America

and

MAS 50 YEARS
Microanalysis Society

as well as the 50th anniversary of the atom probe

ifes
international field emission society

Submit your paper starting December 2016

Paper submission deadline: February 15, 2017

Listen to extraordinary plenary talks from Eric Betzig, Janelia Farm, and Keith Riles, University of Michigan

Attend one of FOUR stellar Pre-Meeting Congresses

Deep dive into specific topics in traditional day-long Sunday Short Courses

Experience hands-on demos for the latest microscopy products during Vendor Tutorials

Discuss recent work in depth with over 500 poster presenters

Visit the largest microscopy exhibit hall in the world with over 120 companies

Hear about cutting-edge scientific work in over 30 symposia in Physical, Biological, and Analytical Sciences

Network with colleagues and friends during happy hours and social events

<http://www.microscopy.org/MandM/2017>

Hitachi strives to provide comprehensive solutions to support your success, not only from inside the lab, but beyond, by providing high-value, innovative, robust, and ergonomic products. Our latest technology demonstrates our commitment to you and the advancement of microscopy.

The All New FlexSEM 1000 VP-SEM

Think Outside the Lab

Novel, compact VP-SEM delivering the performance of a conventional SEM in a lab-friendly footprint with a user-friendly GUI, and only standard wall outlet power required.

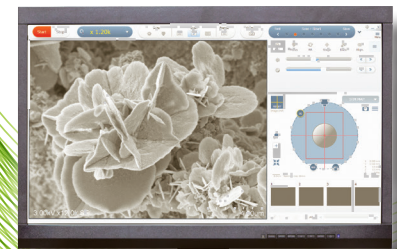

Request a demo or product info: microscopy@hitachi-hta.com

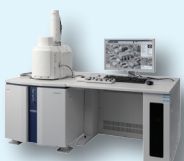

VP-SEM, FE-SEM & FIB

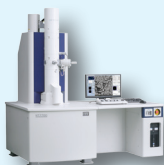

TEM & STEM



Atmospheric SEM

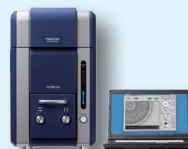

Tabletop SEM



Atomic Force Microscopy



Sample Preparation



**Statement of Ownership, Management, and Circulation
(All Periodicals Publications Except Requester Publications)**

1. Publication Title MICROSCOPY AND MICROANALYSIS	2. Publication Number 021 - 917	3. Filing Date 10/1/2016
4. Issue Frequency FEBRUARY, APRIL, JUNE, AUGUST, OCTOBER, DECEMBER	5. Number of Issues Published Annually 6	6. Annual Subscription Price \$1522
7. Complete Mailing Address of Known Office of Publication (Not printer) (Street, city, county, state, and ZIP+4®) Cambridge University Press 1 Liberty Plaza, New York, NY 10006-1404		Contact Person Nina lammatteo Telephone (Include area code) 2123375000

8. Complete Mailing Address of Headquarters or General Business Office of Publisher (Not printer)
**Cambridge University Press
Edinburgh Building, Cambridge CB2 2RU, England**

9. Full Names and Complete Mailing Addresses of Publisher, Editor, and Managing Editor (Do not leave blank)

Publisher (Name and complete mailing address)
**Cambridge University Press
1 Liberty Plaza, New York, NY 10006-1404**

Editor (Name and complete mailing address)
**Prof. Robert L. Price, Department of Cell and Developmental Biology and Anatomy, School of Medicine,
University of South Carolina, 65439 Garner's Ferry Road, Bldg. 1 b-22, Columbia, SC 29209**

Managing Editor (Name and complete mailing address)
Simon Ross, Cambridge University Press, 1 Liberty Plaza, New York, NY 10006-1404

10. Owner (Do not leave blank. If the publication is owned by a corporation, give the name and address of the corporation immediately followed by the names and addresses of all stockholders owning or holding 1 percent or more of the total amount of stock. If not owned by a corporation, give the names and addresses of the individual owners. If owned by a partnership or other unincorporated firm, give its name and address as well as those of each individual owner. If the publication is published by a nonprofit organization, give its name and address.)

Full Name	Complete Mailing Address
MICROSCOPY SOCIETY OF AMERICA	12100 SUNSET HILLS RD SUITE 130 RESTON, VA 20190

11. Known Bondholders, Mortgagees, and Other Security Holders Owning or Holding 1 Percent or More of Total Amount of Bonds, Mortgages, or Other Securities. If none, check box None

Full Name	Complete Mailing Address

12. Tax Status (For completion by nonprofit organizations authorized to mail at nonprofit rates) (Check one)
The purpose, function, and nonprofit status of this organization and the exempt status for federal income tax purposes:
 Has Not Changed During Preceding 12 Months
 Has Changed During Preceding 12 Months (Publisher must submit explanation of change with this statement)

13. Publication Title MICROSCOPY AND MICROANALYSIS		14. Issue Date for Circulation Data Below AUGUST 2016	
15. Extent and Nature of Circulation		Average No. Copies Each Issue During Preceding 12 Months	No. Copies of Single Issue Published Nearest to Filing Date
a. Total Number of Copies (Net press run)		1862	1836
b. Paid Circulation (By Mail and Outside the Mail)	(1) Mailed Outside-County Paid Subscriptions Stated on PS Form 3541 (include paid distribution above nominal rate, advertiser's proof copies, and exchange copies)	1200	1344
	(2) Mailed In-County Paid Subscriptions Stated on PS Form 3541 (include paid distribution above nominal rate, advertiser's proof copies, and exchange copies)	0	0
	(3) Paid Distribution Outside the Mails Including Sales Through Dealers and Carriers, Street Vendors, Counter Sales, and Other Paid Distribution Outside USPS®	329	316
	(4) Paid Distribution by Other Classes of Mail Through the USPS (e.g., First-Class Mail®)	0	0
c. Total Paid Distribution (Sum of 15b (1), (2), (3), and (4))		1529	1660
d. Free or Nominal Rate Distribution (By Mail and Outside the Mail)	(1) Free or Nominal Rate Outside-County Copies included on PS Form 3541	0	0
	(2) Free or Nominal Rate In-County Copies included on PS Form 3541	0	0
	(3) Free or Nominal Rate Copies Mailed at Other Classes Through the USPS (e.g., First-Class Mail)	0	0
	(4) Free or Nominal Rate Distribution Outside the Mail (Carriers or other means)	7	8
e. Total Free or Nominal Rate Distribution (Sum of 15d (1), (2), (3) and (4))		7	8
f. Total Distribution (Sum of 15c and 15e)		1536	1668
g. Copies not Distributed (See Instructions to Publishers #4 (page #3))		326	168
h. Total (Sum of 15f and g)		1862	1836
i. Percent Paid (15c divided by 15f times 100)		99%	99%

* If you are claiming electronic copies, go to line 16 on page 3. If you are not claiming electronic copies, skip to line 17 on page 3.

 **Statement of Ownership, Management, and Circulation**
POSTAL SERVICE® (All Periodicals Publications Except Requester Publications)

16. Electronic Copy Circulation	Average No. Copies Each Issue During Preceding 12 Months	No. Copies of Single Issue Published Nearest to Filing Date
a. Paid Electronic Copies	0	0
b. Total Paid Print Copies (Line 15c) + Paid Electronic Copies (Line 16a)	1529	1660
c. Total Print Distribution (Line 15f) + Paid Electronic Copies (Line 16a)	1536	1668
d. Percent Paid (Both Print & Electronic Copies) (16b divided by 16c × 100)	99%	99%

I certify that 50% of all my distributed copies (electronic and print) are paid above a nominal price.

17. Publication of Statement of Ownership

If the publication is a general publication, publication of this statement is required. Will be printed in the _____ December _____ issue of this publication. Publication not required.

18. Signature and Title of Editor, Publisher, Business Manager, or Owner	Date
	10/1/2016

I certify that all information furnished on this form is true and complete. I understand that anyone who furnishes false or misleading information on this form or who omits material or information requested on the form may be subject to criminal sanctions (including fines and imprisonment) and/or civil sanctions (including civil penalties).

SEM & TEM Sample Preparation

Microscopy



DESK V TSC

Sample Coater

- Fully automated
- Minimize sample charge
- Reduce e-beam damage
- Increase secondary electron emissions

BENCH TOP TURBO

Evaporation Tool for Tissue and Life Science

- Carbon coating
- Sputtering
- AC glow discharge
- Low-voltage thermal evaporation

Support
Performance
Value

DV-502

Large Sample, High Throughput
Sputter & Evaporation

- Rotary shadowing for metals and carbon
- High vacuum gate valve for rapid cycling
- Recipe development

DENTON VACUUM

Enabling Innovation

All Denton Vacuum Microscopy tools are backed by a 12 month warranty, over 50 years of process knowledge, an in-house process engineering group, worldwide support, and Global factory service center.

To learn more about how to better prepare your samples, contact your electron microscope manufacturer or call us at +1-800-666-6004

www.dentonvacuum.com

INDEX TO ADVERTISERS

Alluxa	A15a
Bruker Nano GmbH	A5, A18
Denton Vacuum	A10a, A23a
Diatome	Cover 3
Electron Microscopy Sciences, EMS	Cover 2, A12, A17
FEI Company	A6, A16
Hitachi	A9, A20
JEOL	A13, Cover 4
Protochips	A11
Scientific Instruments & Applications (SIA)	A10b, A19a
ZEISS	A3, A14

Incomparable...

...and still innovating



DiATOME diamond knives

ultra 45° • cryo • histo
ultra 35° • histo jumbo
cryo immuno • ultra sonic
ultra AFM & cryo AFM
trimtool 20 • trimtool 45
trimtool 90

Over 40 years of development,
manufacturing, and customer service

DiATOME U.S.

P.O. Box 550 • 1560 Industry Rd. • Hatfield, Pa 19440
Tel: (215) 412-8390 • Fax: (215) 412-8450
email: sgkcck@aol.com • www.emsdiasum.com

Free customer service

Sectioning tests with biological and material research specimens of all kinds. We send you the sections along with the surfaced sample, a report on the results obtained and a recommendation of a suitable knife. Complete discretion when working with proprietary samples.

Re-sharpening and reworking service

A re-sharpened Diatome diamond knife demonstrates the same high quality as a new knife. Even knives purchased in previous years can continue to be re-sharpened. The knives can be reworked into another type of knife for no extra charge, e.g. ultra to cryo or 45° to 35°.

Exchange service

Whenever you exchange a knife we offer you a new DiATOME knife at an advantageous price.

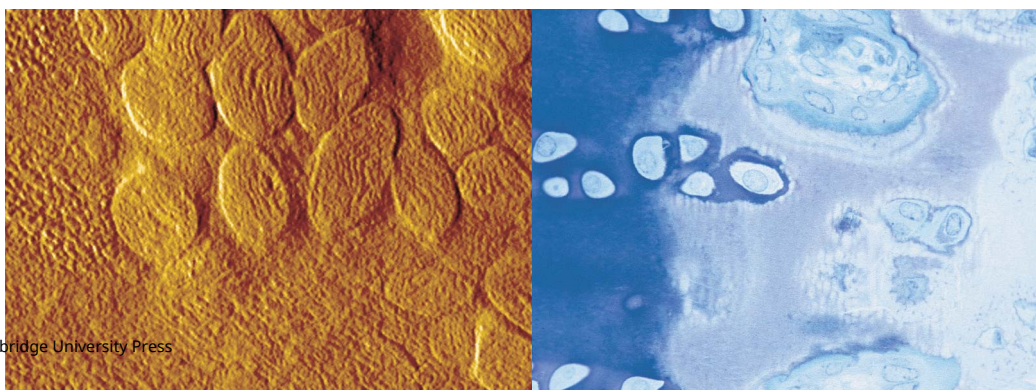

STELLAR RESULTS AT THE ATOMIC SCALE

ARM-200F • ARM-300F Atomic Resolution TEM

- Highest resolution commercially-available S/TEM
- 200kV and 300kV models
- C_s correctors – innovative options
- Cold FEG
- Superior SDD technology
- Ultimate stability

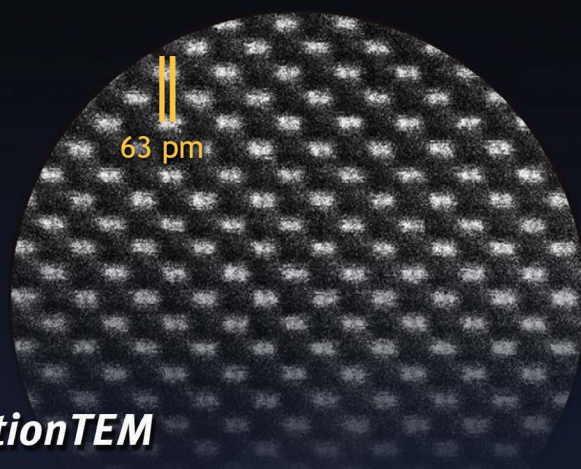

Learn more at jeolusa.com/atomicresolutionTEM

A leader never stops innovating

www.jeolusa.com • salesinfo@jeol.com

Color image: Moon Kim, University of Texas at Dallas • 2014 Grand Prize Winner, JEOL Image Contest