

Aircraft engines: a proud heritage and an exciting future

R. Parker and G. Fedder

Rolls-Royce
Derby
UK

SUMMARY

The 150th anniversary of the Royal Aeronautical Society has seen Rolls-Royce become a global player in aerospace and a champion of British industry. Its products vary from the nimble RR300, powering two-seater helicopters, all the way to the 97,000-pound thrust Trent XWB, powering future variants of the Airbus A350, and the MT30, which provides the propulsion for the Royal Navy's new Queen Elizabeth class aircraft carriers. It has built this range of products derived from the vision and innovation of its talented engineers, spurred on by the guiding principles provided by Henry Royce. This has seen it through times of war, hardship, bankruptcy and fierce competition to emerge as the leading manufacturer of aircraft engines and a provider of power across land and sea. Alongside its products, it has developed pioneering services to support its customers, analysing real-time data to improve the reliability and efficiency of its engines. In keeping with its tradition of innovation, the company is continuing to develop new products and services for the next generation of power systems for land, sea and air.

Keywords: Engines; combustion; aeronautical history; development; design; Rolls-Royce

1.0 THE EARLY YEARS

The long history of Rolls-Royce begins over 100 years ago – coincidentally, only months after the Wright Brothers' iconic 120 ft bound had launched mankind's forays into the skies. The story of this remarkable company begins in May 1904.

The Hon. Charles Stewart Rolls, with a noble upbringing, an Eton and Cambridge education and an enthusiasm for all engines, had been a pioneer motorist. At age 18, he had imported his first car from Paris, a Peugeot Phaeton, which became the first-ever car based in Cambridge. So taken was he with his purchase that he immersed himself in Britain's nascent car market, participating in a variety of races and time trials, becoming one of the founding members of the Automobile Club of Great Britain (later to become the Royal Automobile Club [RAC]). It was there that he encountered the club's first secretary, a certain Claude Johnson – later to be described as “the hyphen in Rolls-Royce”. Together, the pair shared an interest in promoting the horseless carriage and formed a potent partnership in 1902 when Johnson joined C.S. Rolls & Co, a car dealership founded by Rolls to sell imported cars. The pair soon tired of selling imported cars and turned their attentions to the domestic industry, at the time an amateur

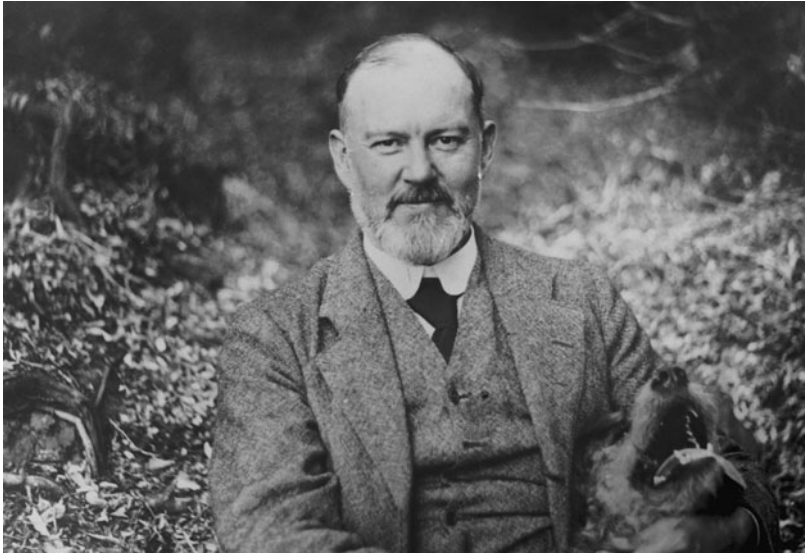

Figure 1. Henry Royce.

affair compared to the more established efforts on mainland Europe. The Automobile Club once again bore fruit, this time in the form of a friend of Charles Rolls, Henry Edmunds, who also happened to be a director of Royce Ltd, a company founded by the meticulous, industrious and supremely gifted Frederick Henry Royce (Fig. 1).

Royce's upbringing could not have been more different from that of Rolls. An older man by 14 years, he had endured hardship throughout his formative years after his father's business failures and early death, when Henry was only nine years of age. He showed great resilience at this time, selling newspapers for W H Smith and earning small amounts of money, but in doing so received only a single year of formal schooling. Nevertheless, transitioning through an aborted apprenticeship at the Great Northern Railway Company and 80-hour weeks as a toolmaker in Leeds, the young Royce began to establish a reputation for diligence that would be reflected throughout his professional career. Following the liquidation of his latest employer in 1884, Royce used his savings to set up what was to become Royce Ltd., with the financial assistance of his business partner Ernest Claremont. After a slow start, the company became well established, with a burgeoning reputation for the quality and reliability of their dynamos and electric cranes, which they sold as far afield as Japan. However, the growing competition from lower-cost rivals and a general interest in all things mechanical had driven its founder to manufacture two prototype motor cars to his own exacting high standards. Frustrated with his own Decauville car, Royce had set out to design a vehicle that was superior in every way: overheating issues were countered with an improved water cooling system, whilst he also put his electrical knowledge to good use in designing a reliable ignition. Meanwhile, the noise issues oft-encountered with the two-cylinder design were mitigated through a meticulous approach to manufacture and assembly. Conscious of the interests of his friend Rolls, Henry Edmunds was sufficiently impressed by these initial prototypes to orchestrate the fateful meeting of the Hon Charles Rolls with Frederick Henry Royce at the Midland Hotel, in Manchester, on 4 May 1904. Thus, the foundation was set for a company whose name endures to this day as one of the only truly global icons of industry, with a reputation determined by the guiding principles of its founding fathers.

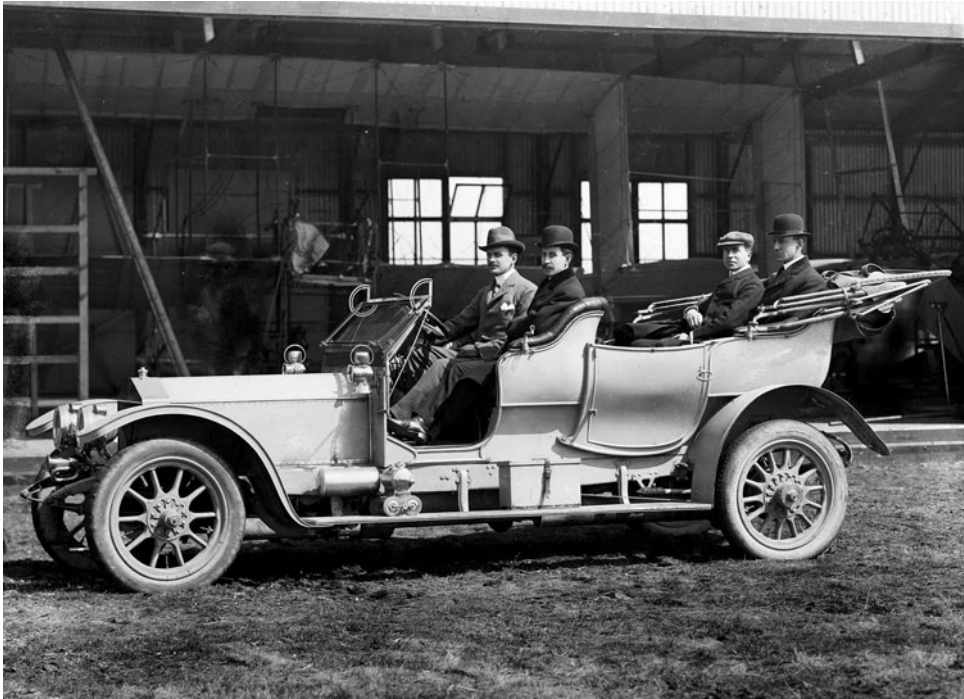

Figure 2. Charles Rolls (driving) and the Wright Brothers in a Rolls-Royce Silver Ghost.

Rolls-Royce Limited was founded in 1906 with a charter to provide “motor vehicles for use on land or water or in the air”, with remarkable foresight given that the first powered flight in Britain occurred in 1908. The new company enjoyed early fame both through its successes in racing and the reputation for the quiet, exceedingly reliable running of its early Rolls-Royce 10 horsepower (hp) and 40/50 models. The latter was eventually to be known as the Silver Ghost (Fig. 2), which cemented the company’s reputation amongst the rich and famous both in Britain and overseas, particularly in the United States. The company’s roots in aviation could be said to stem from Charles Rolls’ keen interest in that domain, which brought him into contact with the Wright Brothers. The pair had recently pioneered flight in what amounted to a controllable, powered glider – showing great vision in developing flight control methods, whilst fitting an engine with only a quarter of the power of their rivals’ designs. The Wright engine was, in fact, a comparatively primitive effort; manufactured in six weeks by their shop mechanic with no fuel pump, a rudimentary carburettor and four cylinders. It did, however, embody a feature which remains a key design characteristic of today’s aero engines: namely, its light weight, courtesy of a relatively novel aluminium engine block. So smitten was Rolls with the “delightful and novel” sensation of human flight that he purchased two Wright Flyers (Fig. 3), one of which (a licence-built example) tragically ended up killing him in 1910 during an air show display. Prior to his early death, his efforts at convincing the company to design an aero engine had not been particularly successful.

It was not until the beginning of the First World War that Rolls-Royce and aviation history became intertwined again. Following a visit by Royce to the Royal Aircraft Factory, Rolls-Royce was called upon to manufacture a Renault air-cooled V8 design in the absence of



Figure 3. Charles Rolls (L) with Wilbur Wright in a Wright Flyer.

any British engines in production. Royce found himself dissatisfied with the French model and set about designing a world-class engine, based on his existing knowledge with the 40/50 engine that powered the world's best car – the Silver Ghost. This water-cooled, six-cylinder car engine, tuned for smoothness and silence, would need a fourfold increase in power to meet the 200 hp requirement of the War Office in order to power a new bomber aircraft. A six-month programme under the famously close supervision of Royce himself yielded a 12-cylinder, weight-optimised and technologically advanced engine, delivering 225 hp on its first runs. In doing so, the company had resisted calls by the Royal Aircraft Factory to manufacture an air-cooled design. Instead, Rolls-Royce's water-cooled effort drew on its existing experience, proving superior in terms of heat dissipation and air resistance (through a lower frontal area) – setting the tone for the many future engines to come. Intensive testing of the new design involved running the engines to destruction and redesigning the failed parts, yielding higher powers and increasing reliability in a manner that became synonymous with Rolls-Royce development campaigns. Thus, the Eagle engine was born and first flew just over 100 years ago to this day in December 1915, marking the first ever ascent of a Rolls-Royce aero engine (Fig. 4). The engine in all its iterations went on to power nearly 50 aircraft, and by 1918 the Eagle Mk VIII was reliably yielding 360 hp. Several variants followed: the Falcon, a scaled-down Eagle, powered the most effective British two-seater fighter of that war – the Bristol F.2B Fighter. The Hawk was effectively a half-Falcon and found use in trainer aircraft and airships. A larger engine, the Condor, delivered up to 650 hp, but initially proved heavy and arrived too late to make a substantial impact on the war.

The war ended rather abruptly in some respects, leaving Rolls-Royce with a production line geared towards supporting the now-concluded wartime effort. Development work on car chassis had all but halted, leaving only a few vehicles produced for the war effort, where they developed an astounding reputation for reliability in the harshest of conditions. Surplus aero engines were sold for scrap value and the Board's attention rapidly turned back towards

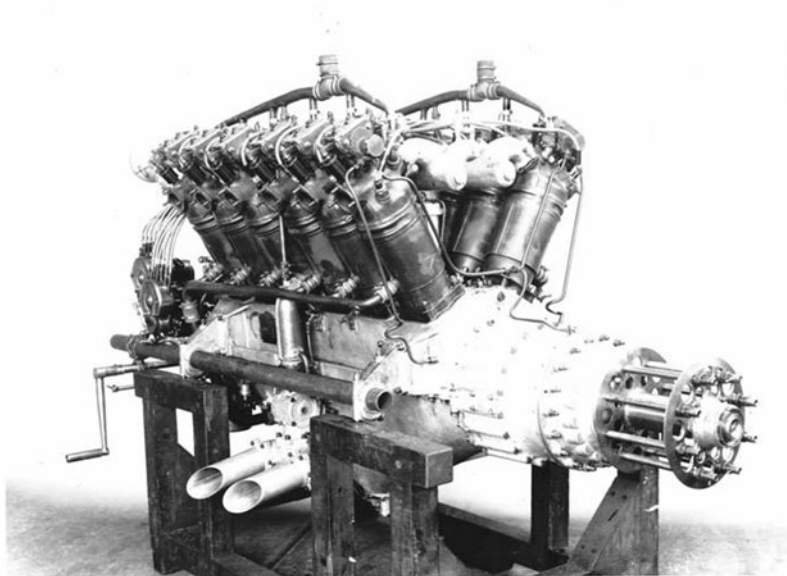

Figure 4. First of a kind – The Eagle.

sustaining the commercial future of the company as government funds dried up. Competitors faced a similar dilemma, which the government was quick to recognise, so four manufacturers – Rolls-Royce, Bristol, Napier and Armstrong-Siddeley – were offered government aid to support the continued production of aircraft engines. However, Rolls-Royce's approach diverged from the others, who continued to develop increasingly capable engines. Napier, in particular, brought their advanced W12 Lion into production, which surpassed its competition in all but reliability. Armstrong-Siddeley, meanwhile, advanced the state of the art in air-cooled engines, bringing a series of successful radials to the market. Having built a reputation for producing Britain's best aero engines during the war, these rapid developments left Rolls-Royce somewhat adrift in the market. This unenviable position threatened to be cemented in 1925, when the Air Ministry made the decision that all future engines for front-line RAF aircraft should be able to be manufactured under licence; a position that only Rolls-Royce disagreed with.

Nevertheless, development of aircraft engines continued on a shoestring budget throughout the 1920s, inspired by great men whose names now adorn plaques in company buildings worldwide. A crucial influence was that of A J Rowledge, a Napier engine designer who had joined Rolls-Royce as Assistant Chief Engineer to Henry Royce in what turned out to be something of a coup. His undoubted talent for aero engine design and perseverance through these years were instrumental, in particular, to the development of the Kestrel. This unheralded V12 lives in the shadow of its successors, but the innovations brought about in its design formed the building blocks for the successes to come. Its aluminium cast block design, pressurised water cooling system and the advent of supercharging gave it a tremendous power-to-weight ratio, forming the platform for a new generation of sleek and potent aircraft.

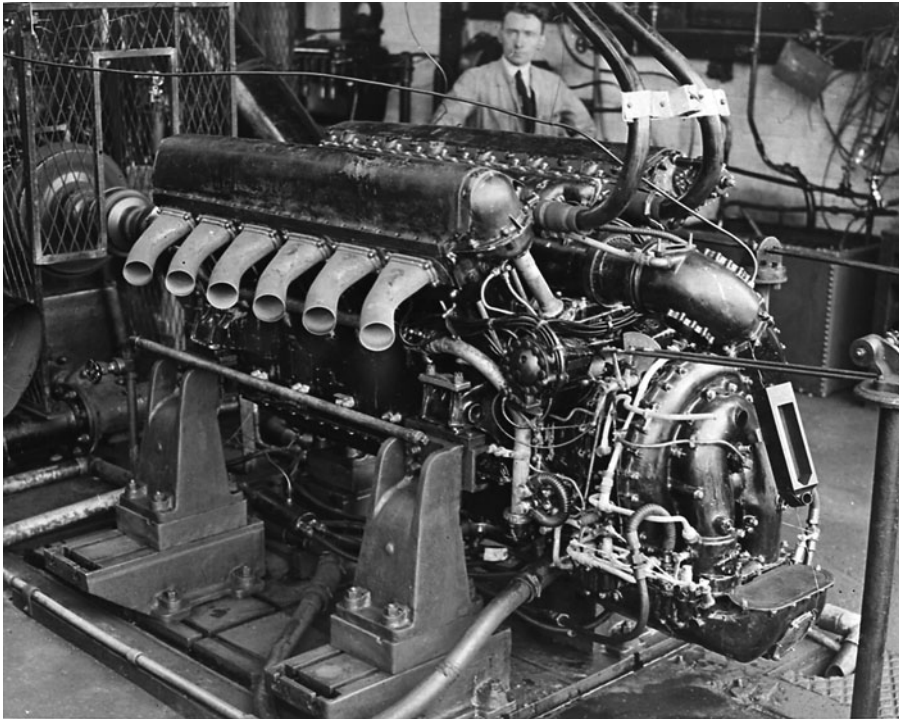

Figure 5. The powerful Rolls-Royce 'R' on a test stand.

1.1 Innovation through competition

Following the war, the pace of industrial progress in Britain in the 1920s slowed noticeably, and the emerging powers of the world in the United States and Italy began leaving their mark. In aviation, competition evolved around the Schneider Trophy, awarded to the fastest seaplane around a closed circuit. British entries until 1927 had largely been based around the now-dependable Napier Lion engine, but the ferocity of competition and a rule change in 1928 brought about an opportunity for Rolls-Royce, albeit not of their own making. That accolade instead rests with Major Bulman, at the time the Air Ministry official in charge of aero engine development. Concerned about the limited potential of the Lion and the lack of progress at Napier, he became aware of the Rolls-Royce 'H' V12. The Buzzard, as the 'H' came to be known, was a scaled-up Kestrel and had shown great promise, despite early mechanical issues. Discussions with Rolls-Royce engineers, including Rowledge, convinced him of the engine's potential and their determination to succeed. Such was his confidence that the company was ordered to develop a racing engine, despite the attempts of Basil Johnson (brother of the late Claude) to avoid this. Basil's argument that "the firm's reputation for sheer quality and perfection should not be smirched by sordid competition of this sort" was rightly dismissed, and indeed led to his untimely retirement once Royce had been made aware of his opinions.

Freed of their shackles, the engineers got to work on the Racing-H, or 'R' as it came to be known, under the guidance of Royce himself (Fig. 5). The engine was based on an established platform, with the Buzzard having become something of a known entity. The power, meanwhile, was to be brought about through a combination of high-performance

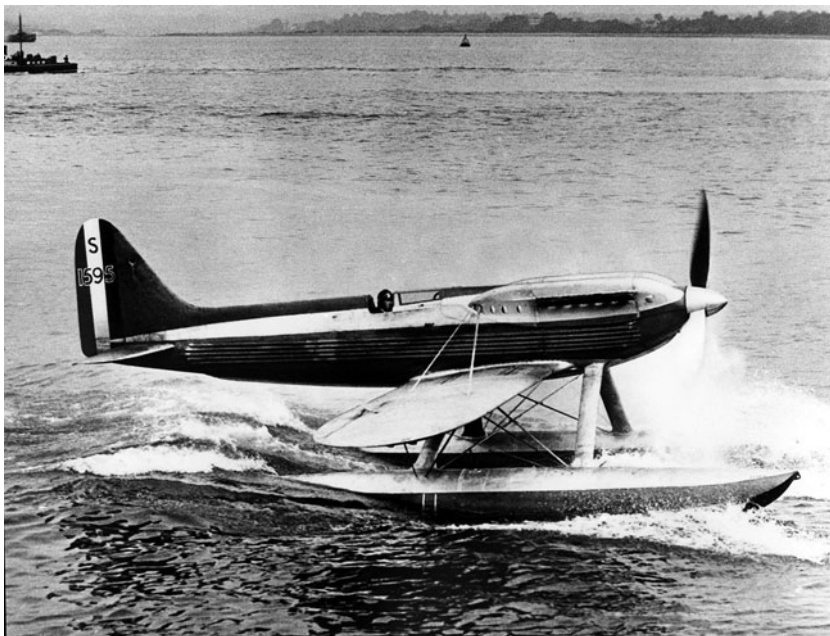

Figure 6. The sleek Supermarine S.6B, winner of the Schneider Trophy. Serial number S1595 pictured here was the aircraft that flew the course and is on display in London at the Science Museum.

fuel and tremendous leaps in supercharging technology. These and other developments enabled the engine to develop a tremendous 1,850 hp in bench testing, versus the base V12's output of 825 hp. This immense power did not come without its issues; the ensuing development campaign led to the destruction of many a component before the engine could be made to run reliably. The troubles did not stop there: once fitted in the Supermarine S.6 seaplane, the engine developed such torque that take-off was nigh-on impossible. The veering motion caused by the engine eventually had to be mitigated by selective ballasting of the floats with fuel (in itself an issue due to the engine's great thirst). Once again, though, the long hours of testing bore fruit in both reliability and power. The Supermarine S.6 and S.6B seaplanes (Fig. 6) added to Britain's 1927 trophy with wins in 1929 and 1931, by which time the strengthened 'R' was developing a mighty 2,350 hp at 3,200 rpm. The three successive wins claimed the trophy outright for Britain, following which a successful attempt at the world speed record was held, becoming the first to break the 400mph barrier. These achievements were to be of great consequence to both Rolls-Royce and Supermarine, cementing a partnership between Henry Royce and Reginald Joseph Mitchell, designer of the winning Supermarine seaplanes as well as the Spitfire. The win proved a huge publicity coup and laid the technological and personal foundations of the famous Merlin–Spitfire marriage.

1.2 The Merlin

No article about Rolls-Royce's heritage can be complete without special mention of the Merlin. Indeed, the company's name and that of its most famous child are inextricably linked and evoke the Hurricane, Spitfire and other marvels of the Battle of Britain. Yet, the engine owes much to its peacetime forebears in the Buzzard, Kestrel, 'R' and later Private Venture

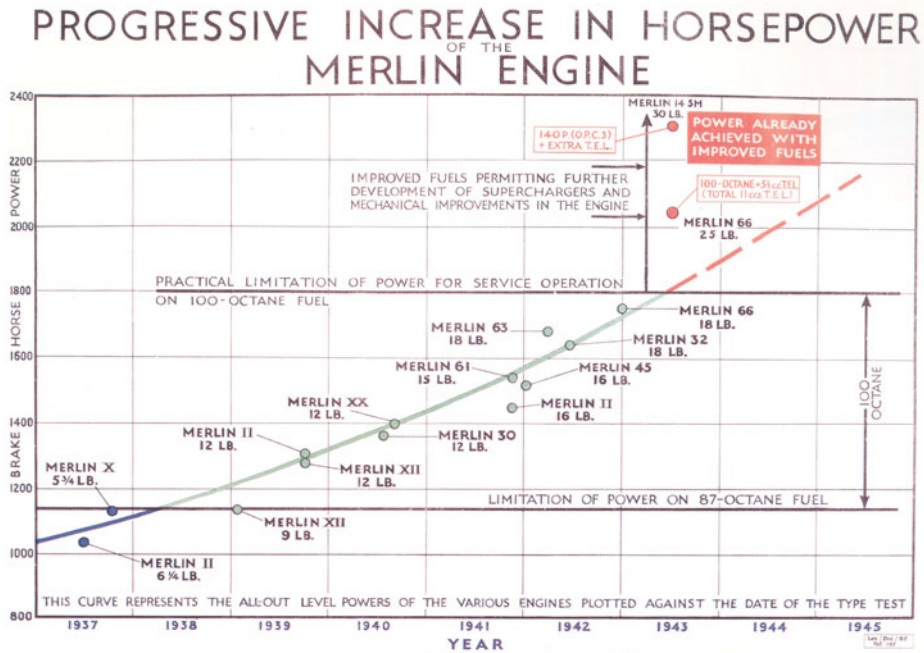

Figure 7. The remarkable increase in power output of the Merlin.

(P.V.) 12. This last engine was one of Royce's last and arguably most important decisions: the development of a privately-funded V12 to power Britain's future aircraft. The P.V. 12 was to combine the reliability of the Kestrel with the performance of the 'R' in a 27L, liquid-cooled, supercharged package. Whilst neither aim was initially achieved, the engine's first run in October 1933 – just six months after Henry Royce's death – demonstrated sufficient potential to warrant further development.

It is one thing to develop an engine with the pressures and financial might of a wartime government, and another to do so in peacetime. That Rolls-Royce had maintained a competitive advantage over its sometimes wealthier contemporaries both domestically and worldwide speaks volumes for the talent and determination of its engineering workforce. The lessons learned in leaner times stood it in good stead when it came to the development of the new engine. Through excellent design, with new manufacturing techniques and occasionally a little trial-and-error, the Merlin emerged and underwent a continuous development programme that pushed piston engine technology to its very zenith by the end of the war. Central to these were rapid improvements in supercharger design, with Stanley Hooker, an Oxford mathematician, at the forefront. The transition from the single-stage through to the two-stage supercharger with intercooler allied with improvements to the duct geometries and higher grades of fuel contributed to an almost-doubling of the "little" engine's power by the end of the war (Fig. 7). It is difficult to truly do justice to the inherent challenge of harnessing the might of an engine to compress the air, then cooling it before it enters the cylinders to avoid detonation. The packaging of this technologically advanced and now longer engine into the Spitfire was achieved within months (Fig. 8); the expertise developed in this field was to prove instrumental to the company's future.



Figure 8. A Rolls-Royce Merlin fitted to a Mk IX Spitfire.

Crucially, these advances also meant that the Merlin's power was available at ever-higher altitudes, ensuring that the British and American aircraft competed with and even surpassed the advanced Germans in both height and speed, giving the British and Americans the edge in high-altitude bombing and interception.

No less instrumental in the success of the Merlin as the technical attributes bestowed on it by its designers was the visionary effort of Ernest Hives in bringing the engine to mass production (Figs 9 and 10). Having begun his career as a mechanic at C S Rolls, he had progressed through the ranks to become a Board member. In doing so, he had developed a reputation for being ever the strong and willing negotiator, and impressed upon the Air Ministry the inadequacy of existing facilities for a future production ramp-up. It was not without difficulty that he oversaw the construction of new 'shadow' factories in Crewe and Glasgow. These were initially distinct from the Derby site in their use of unskilled and semi-skilled labour, with tooling and production lines optimised for single products. Thus, an aero engine whose production run was estimated to be in its thousands was instead turned out in previously unheard-of numbers. Around 168,000 Merlins were eventually produced, including over 55,000 V-1650 variants built under licence by Packard in the United States. The later 37L V12 Griffon is worthy of mention, too, bringing the capacity and power of the 'R' into a streamlined and ultimately remarkably reliable engine: a testament to the pace of development. It is notable that a significant proportion of these thoroughbred engines went on to see success in powering civilian liners following the war, demonstrating their reliability and versatility. The success in their new role was to be short-lived, however, as new technologies rapidly came into play.

1.3 The Jet era

It is, in some ways, unfortunate that Frank Whittle's first run of the 'WU' engine that heralded the advent of the jet age came in 1937 (Figs 11 and 12). This was a time of crucial development



Figure 9. The irrepresible Ernest Hives.

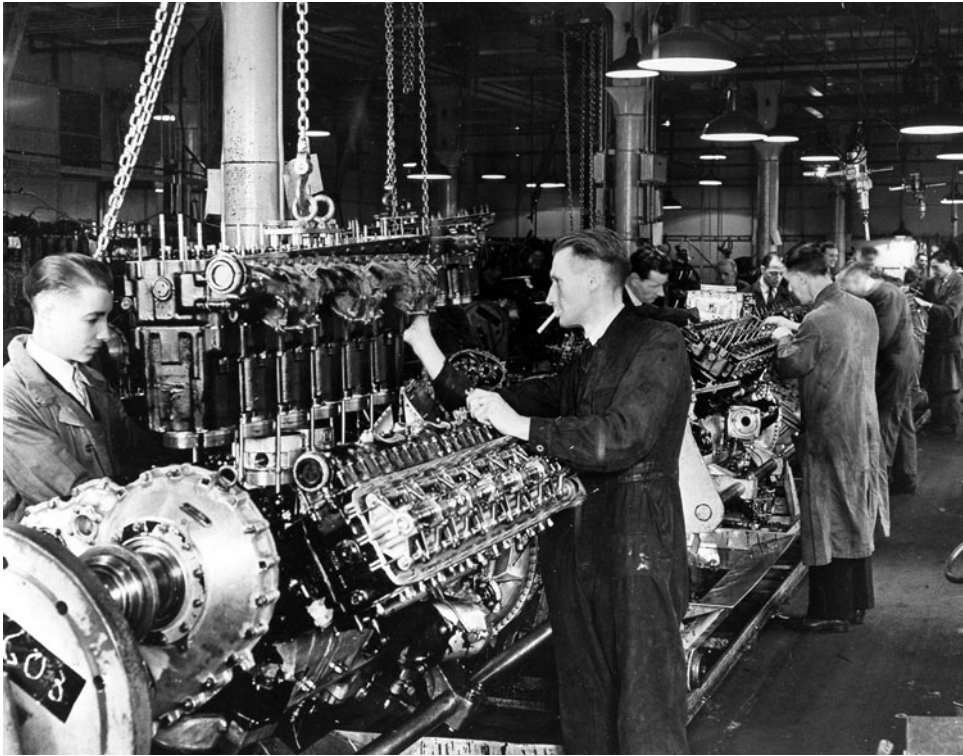

Figure 10. Mass production was critical to the war effort.



Figure 11. Whittle: “the invention was nothing; the achievement was making the thing work!”.

and eventually production ramp-up phases for the aero engine manufacturers, who could ill afford to spare manpower detracting from what was to become the next war effort. The work was instead taken on through contractors and sponsors: at first, British Thomson-Houston (BTH), and subsequently Rover. Still, bearing in mind the significance of his discovery and the almost-unbelievable characteristics that it had exhibited, it is revealing that it took as long as four years from first run to its maiden flight in a Gloster E.28/39 in May 1941. In comparison, the P.V. 12, a more familiar animal, took 16 months. In this time, it took an extraordinary amount of perseverance from an inspired man in Frank Whittle to bring the engine to life in a usable form (Fig. 12). In a journey that ultimately took Whittle to Rolls-Royce, the influence and leadership of Hives once again helped to cement the future of the company. A visit to Whittle’s Power Jets factory and favourable words from Hooker convinced Hives of the viability of the project. Upon learning that they had difficulty in manufacturing components, he asked for drawings to be sent to Derby, so that the components could be made by Rolls-Royce. It was at this visit that Whittle recounts emphasising the simplicity of the design to Hives, who famously replied “we’ll soon design the bloody simplicity out of it!”.

Even with such a simple design, technical issues plagued the project, particularly around the turbine materials and the propensity of the compressor to surging. Rolls-Royce played a key part in solving these issues, helping Whittle with his surging problems using a compressor rig driven by a 2,000 hp Vulture piston engine. However, as Whittle’s design and development

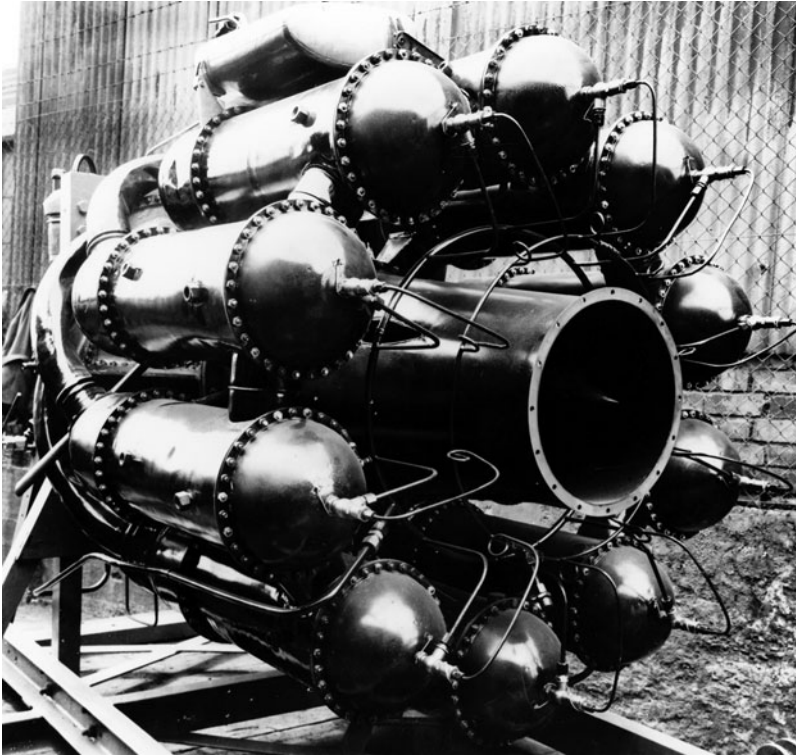

Figure 12. An early Whittle engine.

work continued, he encountered increasing (and, by some accounts, mutual) difficulties with Rover, to such an extent that Rover began a secret project to redesign the engine. Frustrated at the perceived lack of progress two years on from the first flight, the Ministry of Aircraft Production sought a resolution and stepped in. He reached an agreement with Maurice Wilks of Rover, whereby the Rolls-Royce Meteor tank engine factory was swapped with both Whittle's Power Jets and Rover's secret jet engine undertaking. The latter had become the W.2B under the supervision of Adrian Lombard, who was to become one of the world's foremost jet engine designers. The exchange of a well-established production facility for an experimental works was not an obvious one, and particularly did not find favour with those charged with developing Rolls-Royce's existing in-house jet engine design. With hindsight, however, it is an example of rare visionary leadership that changed the very nature of Rolls-Royce's business. The effect of a large, focussed workforce with years of experience in supercharger impeller design was dramatic: within 18 months, the W.2B entered production as the Rolls-Royce Welland and saw frontline service against V1 flying bombs in the Gloster Meteor. From that point on, the rapid gains made in jet engine propulsion relegated the reciprocating engines to smaller applications. The war had proven what the civilian market was about to experience: the unquestioned superiority of the jet engine.

Whittle was not alone in developing jet engine technology at the time. Some mention has already been made of Rolls-Royce's internal designs, inspired by the renowned Alan Arnold Griffith. An early opponent of Whittle's centrifugal design, Griffith had published a seminal paper in 1926 which outlined a proposal for an axial jet engine layout. This architecture



Figure 13. The Jet Pioneers: Frank Whittle (left) and Hans von Ohain.

promised a lower frontal area and simpler, more modular design than the bulky centrifugal compressor. However, the industry had accrued vast expertise in centrifugal ‘blowers’ through supercharger designs, promising a simple and well-understood architecture. Nevertheless, Griffith’s paper had spawned a raft of experimental developments in Britain, an example of which was the advanced, if complex, Metropolitan-Vickers F.2 (later to become the Armstrong-Siddeley Sapphire).

1.4 Developments abroad

German efforts began under the equally talented Hans von Ohain, a German physicist who had patented his own version of the jet engine in 1936 (Fig. 13). Having convinced Ernst Heinkel of the concept, development work and construction of the Heinkel HeS 1 proceeded swiftly, resulting in a first run on gasoline (previous runs had used hydrogen) in September 1937. Further development work proceeded, and the improved HeS 3 powered the first-ever flight by a jet aircraft when the Heinkel He 178 took to the skies on 27 August 1939 – remarkably, almost two years ahead of the E.28/39. However, development of his centrifugal design slowed from that point on and he was overtaken by Junkers (under the shrewd Herbert Wagner) and BMW. Their axial compressor designs pioneered by Wagner yielded two production engines: the BMW 003 and Junkers Jumo 004, the latter of which was to find fame in the Messerschmitt Me 262. Both of these engines were worthy candidates in that they contained truly revolutionary technology which is still in evidence in modern designs. The BMW 003, for example, featured a novel annular combustion chamber between a seven-stage compressor and single-stage turbine. Meanwhile, the Jumo 004 was a similar design with more conservative can-type combustion chambers, yet it featured a novel variable-geometry exit nozzle. Additionally, in order to mitigate issues with turbine blade overheating, compressor air was bled through the turbine blades to cool them – a feature which is still essential on

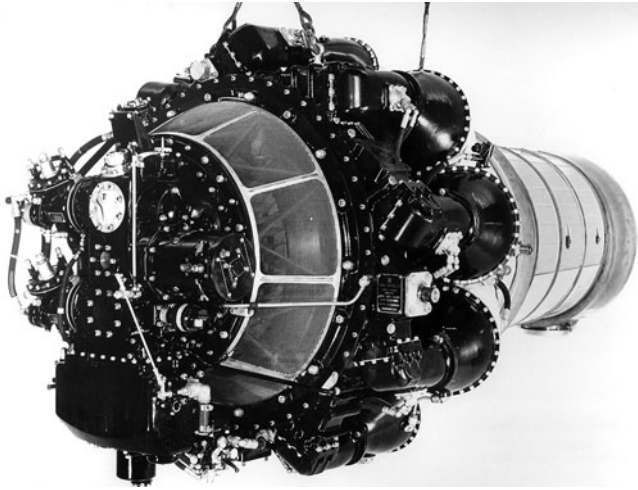

Figure 14. The Rolls-Royce Nene, which was manufactured under licence by Pratt & Whitney in the United States.

contemporary turbine blades. The Jumo design proved slightly less unreliable, although much was learnt through the development phases of these engines on coatings, material properties, vibration and throttle response. Ultimately, the German designs were to be undone by the lack of suitable materials available in Germany at the time. The use of less-capable materials made for cheap, rapid manufacture, but the engines could not last more than 50 hours on wing at best, in contrast to the early British designs, which were surpassing 150 hours. The end of the war heralded the temporary demise of jet engine manufacture in Germany and a mass exodus of engineering talent to America as well as to the Soviet Union.

Finally, some mention should be made of developments in the United States, which initially followed the Whittle design before branching into axial designs by Westinghouse, General Electric and Allison. These are discussed in the next section.

2.0 THREE PATHS: EFFICIENCY, SPEED AND VERTICAL LIFT

2.1 Efficiency

Following the war, Rolls-Royce took the decision to enter the rapidly expanding realm of commercial aviation under the stewardship of the highly regarded Hives. The company had established a reputation for excellence in engineering both in Europe and in America through the licencing of the Merlin, which was produced in enormous volumes – up to 80 per day in the summer of 1944. Hives acted quickly to capitalise on this position by offering the Merlin for passenger-carrying applications, initially on military-derived aircraft designs. However, the company had by now garnered sufficient experience with the jet engine to recognise its huge potential, and internal development of the first clean-sheet designs continued apace under the supervision of Stanley Hooker. The Derwent and Nene (Fig. 14), as they came to be known, were still conservative designs by the standards of the day in 1946, featuring a centrifugal compressor and otherwise not dissimilar architecture to the Welland. An all-

axial design labelled the AJ-65 was also in development, following A A Griffith's early work. Meanwhile, the competition was still evolving, with the devastation in Europe leaving American manufacturers as the only credible international threats to Rolls-Royce's enviable position. Initial competition came in the form of designs from Westinghouse and General Electric, which proved underdeveloped – a result of the US government's insistence that the war effort should be prioritised over jet engine development. Nevertheless, the rapid post-war ramp-down in engine production left American manufacturers with spare production capacity and an engineering workforce free of the constraints of wartime.

Hives was quick to recognise the opportunity, opting to enter the market through a licensing agreement with Pratt & Whitney, who undertook production of the Nene (J42/JT6) and later the Tay (J48/JT7). This fruitful partnership yielded 5,000 engine sales to the US military and was to the benefit of both companies, enabling them to gain a foothold in the nascent market. However, Pratt & Whitney's roadmap had them entering the jet engine market in the 1950s, which they duly did through military contracts with the 10,000-pound (lb) thrust class J57/JT3. This immensely popular engine laid the foundation for Pratt & Whitney's dominant position in the military domain and their continued success in the commercial market, thus making them out as one of Rolls-Royce's prime competitors for decades to come. Nevertheless, the inevitable termination of the agreement between the two companies was conducted in amicable terms, a testament to the respect for each other's engineering prowess. This split did not mark the end of Rolls-Royce's licencing forays in America. A further attempt with Westinghouse provided much-needed revenue for Rolls-Royce but never led to significant sales, arguably setting back Rolls-Royce's attempts to penetrate the American market.

2.1.1 Development of the turboprop

Meanwhile, domestically, Rolls-Royce continued to work on propeller-driven propulsion, albeit of a slightly different form. An additional turbine stage provided the necessary power to drive a reduction gearbox on the front of a Derwent turbojet, to which a large five-bladed Rotol propeller was fixed. Thus, the Rolls-Royce turboprop came into being. This engine became the Rolls Barnoldswick 50 Trent (the Rolls Barnoldswick was abbreviated as RB and referred to Barnoldswick, being Rolls-Royce's centre for aero engine design at the time). It was first test-flown on the Gloster Meteor aircraft in September 1945; the subsequent flight test campaign provided invaluable learning, which fed into the ensuing production designs. The indigenous turboprop family turned out to be comparatively small in number, but exceedingly successful in application. The first of two engine types was the RB.53 Dart, first flown in a converted Avro Lancaster as early as October 1947. This compact, yet slightly stubby, initially overweight design featured a centrifugal compressor, against the axial technology of the competition in the sleek Armstrong-Siddeley Mamba and ultimately unsuccessful Napier Naiad. A drastic weight-reduction exercise (bringing the engine down from 1,100 lb to 800 lb) as well as an increase in power and the proven nature of the power plant led to its selection on the Vickers Viscount (Fig. 15), where it saw tremendous success. Its reputation for quiet, reliable operation grew and it remained in production until 1987, by which time it had grown from a 1,000-shaft horsepower (shp) class engine to producing over 3,000 shp. Over 7,000 were produced for around a dozen aircraft types, of which around 300 remain in service to this day. The second turboprop type was the larger, more powerful 4,000 shp Tyne, initially test-flown on an Avro Lincoln in 1956. This potent engine was able to power the four-Merlin Lincoln test aircraft by itself and proved significantly more fuel-efficient than the Dart – a testament to the progress in jet engine technology in just ten years. Nevertheless, it entered the market



Figure 15. The Dart-powered Vickers Viscount – a quiet, smooth-flying aircraft in its day.

at a time when aircraft designs were trending towards pure jet power, and sales suffered as a consequence. The Tyne was the last of a line, with ensuing Rolls-Royce turboprops coming from the purchase of Allison in the 1990s.

2.1.2 The Turbofan

Development of the jet engine continued apace. The aforementioned AJ-65 became the Avon and marked Rolls-Royce's entry into the axial compressor domain. A troubled development period was safely navigated with the input of several legendary names, from A A Griffith to Adrian Lombard, Stanley Hooker and Cyril Lovesey, some of whom proved vital to the eventual success of the RB.211. In any event, the Avon prospered in a variety of applications – particularly, military aviation – and proved a building block for the company's progress both in aviation and in industrial power. However, with efficiency translating directly into range and lower operating costs for the airlines, the turbojet Avon was a mere stepping stone in the rapid development of civil engines. Next came the Conway, a historically significant 10,000 lb class engine. This built on Avon compressor technology and introduced two vital steps. The first was a split of the engine into two coaxial spools. The high-pressure spool formed the core of the engine and ran efficiently fast and hot, whilst the low-pressure spool bookended the core and spun slower. This enabled Rolls-Royce to fit a comparatively large diameter fan at the front; the second crucial step. The large fan moved substantial amounts of air in a manner not unlike a propeller, such that a significant proportion of the air was directed in a 'bypass' channel around the outside of the core. This bypass turbojet engine – or turbofan, as it came to be known – became the architecture of choice for all civil jet engines to this day (turboprops



Figure 16. Conways fitted to an Air India Boeing 707.

notwithstanding), a testament to the importance of the Conway as the world's first production turbofan.

2.1.3 *The RB.211*

Unfortunately for Rolls-Royce, the Conway's advanced architecture did not translate into commercial aviation sales aside from a small number on the Boeing 707 (Fig. 16), Douglas DC-8 and Vickers VC10. Domestic jet-powered aircraft had seen limited success in the face of the outstanding examples produced by Boeing and Douglas, powered by the successful Pratt & Whitney JT3D turbofans. Along with the abortive attempts at entering the American market through Westinghouse, this had left Rolls-Royce in an uncompetitive position by the 1960s.

Fortunately, the mid-60s saw new opportunities in the world of commercial aviation, with American Airlines announcing their requirement for a new 250- to 300-seat, coast-to-coast aircraft to fulfil the requirements of their busiest routes. The still-patchy reliability of contemporary engines dictated that a three-engined aircraft would be required to meet Federal Aviation Administration (FAA) drift-down requirements over the Rockies, as well as placating those airlines that flew significant over-water routes. Two platforms were offered for this purpose: the Douglas DC-10 and the Lockheed L-1011. At the same time, a new consortium

was forming in Europe to design a short-haul widebody, later to become the A300, and Boeing was betting the company's future on the ultra-large, long-haul 747 in response to Pan Am's requirements. Rolls-Royce was not standing idly by. The company had begun development of its high-bypass-ratio turbofan, matching the efforts of its two main competitors in the United States – General Electric and Pratt & Whitney. A succession of studies gave rise to the RB.178-16, a two-spool demonstrator which proved the high-bypass concept (with a bypass ratio of 2.3 against the Conway's 0.6). However, whilst it was designed to be aerodynamically representative of future engine architectures, budgetary constraints meant that it was fitted with a rudimentary high-pressure (HP) turbine, which limited running. Budget overruns and severe mechanical issues, including material loss from the combustor and HP nozzle guide vanes, saw the cancellation of this project, meaning that there was only limited opportunity to de-risk key technologies. This was a decision that the company was later to regret during the troubled phases of RB.211 development. Meanwhile, the company had begun on three-spool designs in smaller, 10,000 lb thrust engine classes with the RB.203 Trent, as well as offering this architecture in a larger form to Boeing as an evolution of its demonstrator; the RB.178-51. The three-spool design was intended to allow each compressor to run at its optimal speed, making the engine more efficient and producing less noise. Whilst inevitably more complex, a by-product of this design was a shorter, stiffer engine – leading to better through-life performance retention characteristics – a feature of Rolls-Royce triple-spool power plants to this day. The RB.178-51 engine competed with Pratt & Whitney's JT9D to power the Boeing 747, initially on Pan Am's aircraft, for which Pratt & Whitney were the incumbent. Although unsuccessful, the Rolls-Royce management learned many lessons in this campaign which were to prove useful in their response to the American Airlines requirement.

The three-spool architecture formed the basis for two campaigns: the 50,000 lb class RB.207 for the A300 and the 40,000 lb class RB.211 for the DC-10 and L-1011 (Fig. 17). After fierce competition on all three platforms, Rolls-Royce became the sole supplier for the L-1011 in March 1968, having heavily discounted the RB.211 to achieve this on what was to prove the weakest of the three aircraft in terms of sales. Signs were therefore ominous before even the beginning of a hugely ambitious development programme, aiming for entry into service in 1971. The engine's design objectives were tremendous, calling for a clean-burning engine developing over twice the thrust of the Conway, alongside step-change reductions in fuel consumption (–21%) and noise level (around a quarter of the Conway's). It was to achieve this through a large bypass, higher compressor pressure ratio, increases in turbine temperatures and the application of novel composite technologies. The most famous (or infamous) application of composites was a carbon fibre-based material called Hyfil, from which the fan blades were to be made. This light, stiff material enabled Rolls-Royce to design a lighter containment casing and fanset, greatly reducing the overall weight of the engine. This had been in development for some time with the Royal Aircraft Establishment and had been flight-tested in the Conway. Nevertheless, this material was regarded with some suspicion both within and outside the company (including the great Joe Sutter, designer of the 747) and titanium fan development continued in parallel.

Progress from 1968 through 1970 was laboured, with the engine struggling to meet thrust, performance, or weight guarantees and component failures curtailing almost every test. These failures particularly affected the hot end of the engine, with the turbines undergoing multiple design iterations – a process which might have begun several years back had the RB.178-16 demonstrator been run to its full potential. The heavier, more expensive solid titanium fan soon became reality following several catastrophic failures of the Hyfil fan, which proved incapable of passing bird strike requirements. Additional headwinds came through



Figure 17. The Rolls-Royce VC10 Flying Testbed, with one prototype RB.211 replacing two Conways.

demands from Lockheed, for a change in the aircraft mounting points (causing a further increase in engine weight) and a bump in take-off thrust to 42,000 lb, which the company absorbed without financial compensation. In 1970, following further impediments, a team of experienced engineers affectionately known as “Dad’s Army” were assembled to assist in the design efforts. These were Stanley Hooker, Cyril Lovesey and Arthur Rubbra (all retired, having been instrumental to the Merlin’s success) as well as Lionel Haworth (who had led the design of the Dart). Despite their input, by February 1971, the expensive development programme, low selling price of the engine and falling revenues from Rolls-Royce’s legacy products had come to a head. Unable to finance the programme any longer, the company was placed into receivership and, ultimately, government ownership (Fig. 18).

In this context, the subsequent turnaround in the company’s fortunes is all the more extraordinary. The story is, as is the Merlin’s, well told and begins on the day before the company was placed into receivership. On the evening of 3 February 1971, Engine 10011 was run with a number of performance improvements, the culmination of significant work undertaken the previous year. It ran well and its performance was significantly improved over previous engines – proving sufficiently good for engine deliveries to Lockheed. This crucial result marked a watershed moment in the RB.211 programme and, indeed, in the future of the company.

Development of the RB.211-22B engine, as the L-1011 variant came to be known, continued apace under government ownership. Entry into service came only 4½ months late, an exceptional result given the difficulties that both the engine and company had faced. Nevertheless, revenue flights posed a new set of challenges as reliability issues began to be exposed. In keeping with past programmes, progress was rapid and the engine continued to be improved, leaving a positive impression on the airlines. As early as 1971, its engineers had

Cont... *WILL SKETCH*
4/2/71
YORKSHIRE
POST 4/2/71

**Cabinet meets,
shares plunge**

*DAILY
EXPRESS
4/2/71*

**ROLLS
ROYCE
CRISIS
NIGHT**

ROLLS-ROYCE
(See this page).
After meeting of Rolls-Royce
directors in London, Mr.
Whitney Stratton, former chair-
man, said that financial
company's collapse, said: "I
won't know so."

Mr. Rolls, at the controls of early bi-plane
**From Cooke-St.
to glory...**

ROLLS-ROYCE began, humbly enough, in Cooke
Street, a not too glamorous thoroughfare in Man-
chester. There in 1885 Henry Royce, a former news-
boy and self-taught mechanic, turned a moderately
profitable generator works into a company to produce
motor cars.

With luck and the help
of friends, the Rolls car
company staggered along,
winning the 1891 Royal
Trophy in 1900 to attract
attention to itself, and
moving later to works in
Derby.

The name at the other
end of the R-R hyphen
was added when Royce
befriended the Hon.
Charles Rolls, son of Lord
Langdale.

Rolls, well-connected in
society, was a dashing
young man, who loved
racing cars, and who
started out to be an car
salesman.

He allowed Royce to
show his cars in his Lon-
don showroom in Conduit
Street. And the famous
partnership was born.

By
ROY MACKIE and WILFRID SENDALL

Cont...

Figure 18. Cash flow problems as a result of the RB.211 programme forced the company into receivership.

sufficient confidence to commence working on a growth variant of the engine, the RB.211-524B. This engine was rated at 48,000 lb of thrust but over-delivered, thus 50,000 lb were offered to the airlines with promises of future thrust growth. Crucially, the engine was also hugely more fuel-efficient than its predecessors, offering a 7% reduction in fuel burn over the RB.211-22B. With the engine now in the 747 thrust range, the sales team went back to Boeing – this time with more success. The engine had significantly better fuel consumption characteristics than either of the incumbent (GE CF6 and Pratt & Whitney JT9D) engines and soon gathered orders, attaining a significant market share on the 747 and establishing Roll-Royce in the long-haul market. Arguably more important was the fact that Rolls-Royce now had a foot in the door of what was to prove the most successful aircraft manufacturer of the 20th century. Boeing was to launch a family of aircraft that proved vital to the enduring success of the RB.211.

The first of these, the narrowbody 757, saw Rolls-Royce (after a brief flirtation with Pratt & Whitney over a jointly developed JT10D engine) offer a variant of the RB.211-524 with a smaller fan and several improvements to the core. The RB.211-535C saw off stiff competition from Pratt & Whitney's new and efficient offering, the PW2037, by rapidly evolving into the lighter, quieter RB.211-535E4. This engine benefited from a number of demonstrator programmes, such as the Quiet Engine Demonstrator and High Temperature Demonstrator Unit (HTDU). It featured technology that would become commonplace in future Rolls-Royce engines, such as 3D-aerodynamically modelled compressor aerofoil and a thermal barrier coating on the HP turbine blades. Its most important advance, however, came in the form of Rolls-Royce's first production hollow wide-chord fan blade, with a honeycomb core. This

concept had initially been pursued in the mid-1960s, but development was halted as funding dried up. The blade was not only aerodynamically superior but also significantly lighter than its solid predecessor, which enabled a further weight saving in the containment ring. It was a key enabler for the engine's low noise characteristics, which were instrumental to its success, making the Rolls-Royce powered aircraft the only 757 that could operate at the time out of noise-restricted airports such as Washington National. The improvements led to a huge order from American Airlines for 100 aircraft (50 firm/50 options) and put the engine well on its way to garnering the majority market share on the 757. There, it attained a stellar reputation for reliability, with an RB.211-535E4 setting a record for time on wing of 40,531 hours on an Icelandair aircraft.

2.1.4 The Advent of the Trent

The evolution of the RB.211 continued through the 1970s and 1980s, with the insertion of technology, the increased use of titanium and improvements to the turbines keeping the engine competitive on newer variants of the 747, 757 and 767. In doing so, the engine grew in thrust, eventually developing over 60,000 lb in its later years – an astonishing growth over the original 42,000 lb for the TriStar. As such, the company was well placed when, in the mid-1980s, a new widebody competition emerged amongst the airframers. Airbus launched the A330/A340 family of aircraft, which McDonnell Douglas countered with the MD-11 trijet and Boeing studied a larger 767X concept, which was to become the 777. This presented the engine manufacturers with a thrust range of 50,000 lb to 90,000 lb, to which Rolls-Royce responded with a family of engines, based on the same, proven fundamental architecture of the RB.211.

The Trent family (Fig. 19), as it came to be known, readily scaled to meet the demands of the different platforms and featured technological improvements throughout the engine as well as significant weight and cost-reduction efforts. The Trent story began with an advanced development of the RB.211 – the RB.211-524L – which became the Trent 600 for the MD-11. The Trent 700 for the A330 was developed almost in parallel and became the first of the Trent family when the Trent 600 was cancelled early in its development programme. The Trent 700 became the leading engine on the phenomenally successful A330 and is still due to be in production 20 years after its 1996 entry into service. It featured many innovations over the RB.211 architecture: new materials were introduced throughout on components that had benefited from the latest in 3D modelling techniques. Importantly, the latest standard of wide chord fan blade was also introduced (Fig. 20). This improved on the honeycomb blade by introducing a new manufacturing process; superplastic forming and diffusion bonding (SPF/DB). The SPF/DB blade features girders inside the two outer panels with high-strength joints, enabling a lighter, cheaper blade. The Trent 800 improved on the Trent 700 core, with a larger fan driven by an extra stage in the low pressure (LP) turbine along with more efficient compressors. Its substantially lighter weight and reliability saw off competition from both General Electric and Pratt & Whitney's offerings on the first-generation Boeing 777. Finally, the smaller Trent 500 became the sole engine for the larger A340-500/600 aircraft, which enjoyed some success in the face of stiff competition from the 777.

Further success followed in the 21st century as the Trent architecture continued to evolve. The larger-diameter swept fan blade, contra-rotating spools, the latest compressor aerodynamics and further steps in turbine design have established the Trent 900 and Trent 1000 in strong competitive positions on the Airbus A380 and Boeing 787 Dreamliner, respectively. The latest in the family – the Trent XWB – is the most efficient civil large engine produced to date and enjoys exclusivity on the Airbus A350 XWB, where it is Rolls-Royce's

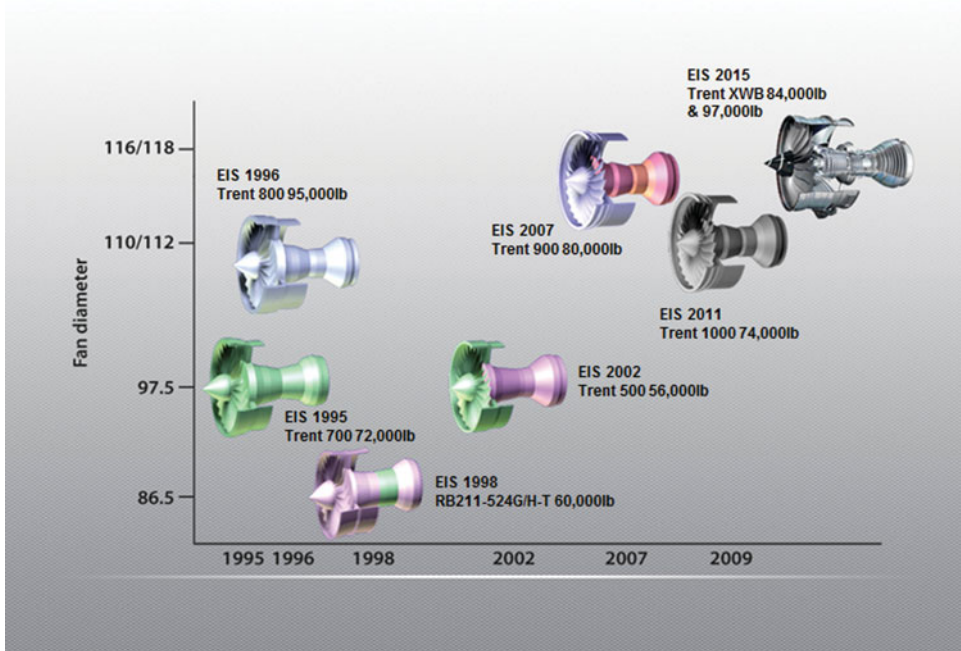

Figure 19. The evolution of the Trent family.

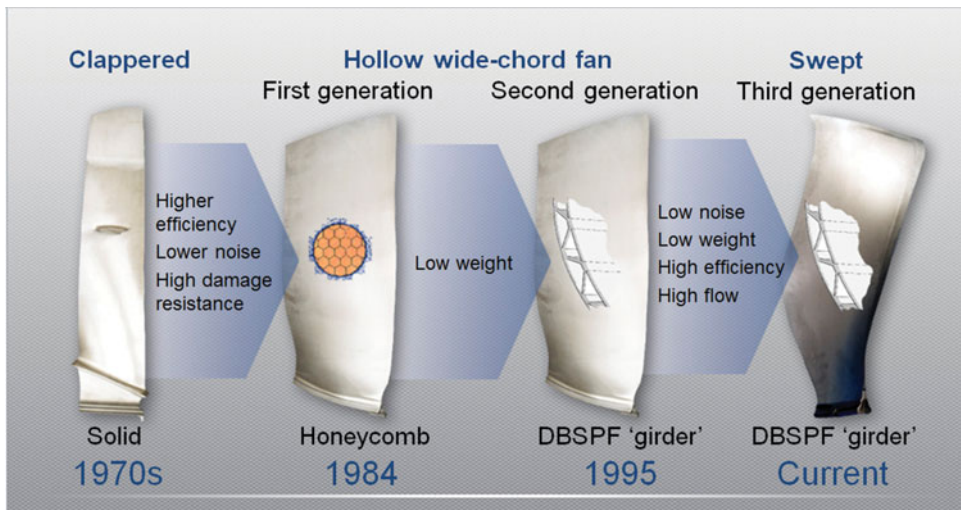

Figure 20. The evolution of the fan blade was key to the Trent family of engines.

fastest-selling engine. Through the evolution of the fundamentally sound RB.211/Trent three-spool architecture, Rolls-Royce has enjoyed spectacular success in the widebody market, propelling it from a small but significant player when privatised in 1987 to the market leader in



Figure 21. A Spey undergoing installation on a Grumman Gulfstream II.

2015. At the time of writing, the Trent engine family counts almost 3,000 engines in service, with another 3,000 on order.

2.1.5 Corporate and Narrowbody

The RB.211 and Trent families formed the basis of Rolls-Royce's offerings in the widebody sector. Meanwhile, Rolls-Royce aimed to have a strong, continued presence in the market for smaller engines, which it eventually achieved through a variety of partnerships and acquisitions.

This journey found its beginnings in Rolls-Royce's initial forays into the corporate market. Having established itself on the Grumman Gulfstream I turboprop aircraft with the Dart, the company found itself in an excellent position to offer the Spey turbofan for the Gulfstream II jet (Fig. 21). This engine had been developed as a smaller counterpart to the Conway and proved well suited to this application. Its outstanding reliability and performance helped cement Rolls-Royce's position as a contender in the corporate sector, which it consolidated in the 1980s with the introduction of the Tay. This turbofan benefited from technology insertion from the now-mature RB.211 programme and went on to power a variety of corporate and regional aircraft, even being offered as a retrofit to the venerable 727.

The German aero engine industry was given a significant infusion of new blood in 1990 with the formation of a joint venture between BMW and Rolls-Royce; BMW Rolls-Royce

Aero Engines GmbH. The partnership was formed with the intention of developing and manufacturing a new family of aero engines. Based on a common, robust and efficient core, the BR700 series of engines emerged and the first BR710 flew only five years later in November 1995. The design was a twin-spool turbofan with origins in the Tay, ranging from approximately 15,000 lb to 20,000 lb thrust. Several variants evolved from this core; the BR710 went on to power both leading large-cabin, ultra-long range corporate aircraft types of the 1990s: the Gulfstream V and Bombardier Global Express. It has cemented its market-leading credentials, becoming the power plant of choice on the Gulfstream G500 and G550 aircraft as well as the Bombardier Global 5000 and Global 6000 business jets. The BR725 features a larger fan and flies on the Boeing 717, where it has earned a reputation for fuel efficiency and low emissions, which has contributed to the 717's recent renaissance. The BR700 series continues to be developed for new platforms to this day following BMW's exit from the venture in 1999, leaving the renamed Rolls-Royce Deutschland under full control of Rolls-Royce plc. Most recently, the BR725 has entered into service on the Gulfstream G650 and G650ER, the latter a record-breaking aircraft that is capable of circumnavigating the globe with only one stop.

In the larger narrowbody market, the company endured something of a hiatus (some Spey and other applications aside) following the failures of the British aircraft manufacturers to produce a product that truly threatened the dominant position established by the American airframers. The advent of the Airbus A320 in the mid-1980s opened up a new opportunity to challenge General Electric in this domain. The all-conquering CFM56 by CFM International (a 50:50 joint venture between GE Aviation and Snecma of France) had established itself in the late 1970s and early 1980s on a variety of platforms. It was its incumbency on the Boeing 737, however, which saw it sell in huge volumes, thus Rolls-Royce and Pratt & Whitney decided to join forces, having been developing their RJ500 and PW2025 concepts, respectively. The two companies formed the International Aero Engines (IAE) joint venture in 1983 along with MTU Aero Engines of Germany, the Japanese Aero Engine Corporation and FiatAvio (later Avio), who withdrew early on. IAE began work on the V2500, so named as it was originally offered in the 25,000 lb thrust class, for the A320 series. Rolls-Royce took on the HP compressor, a scale-up from a demonstrator, whilst Pratt & Whitney developed the combustor and HP turbine, MTU the LP turbine and the Japanese Aero Engine Corporation took on the LP compressor. Development was initially troubled, with technology transfer issues and Rolls-Royce's compressor, in particular, plunging the programme into crisis. Nevertheless, efforts on all sides and a radical redesign saw the engine emerge in the late 1980s. Its performance (particularly on the larger A321) saw it overcome CFM's head start to capture around 45% market share across all A320 variants, a testament to the achievements of a truly global venture. Rolls-Royce left the IAE consortium in 2012 to focus its efforts on widebody and corporate developments, but with the intent to re-enter the market with a suitable product for an all-new aircraft in the future.

The final piece of the narrowbody and corporate puzzle comes with the acquisition of Allison. The American company enjoys a similarly rich heritage to Rolls-Royce, beginning in the early 20th century in the automobile industry before branching out into aviation. The Second World War saw it privately develop an engine which eventually emerged as the only American indigenous wartime liquid-cooled V12 – the V-1710. This engine compared well to the Merlin, offering similar sea-level performance in a less complex package, which grew in output from 1,000 hp to around 2,000 hp by the end of the war. The advent of the jet age saw the companies' strategies diverge, as Allison initially took on licenced production of General Electric jet engine designs. The late 1940s and early 1950s saw the company embark on the



Figure 22. A pair of AE3007s power the Cessna Citation X business jet.

development of its own turboprop engine, which culminated in the incredibly successful T56. This robust, reliable engine has continued to evolve and has seen operation worldwide on a variety of military types, including the versatile C-130 Hercules. It is still in production to this day, over 60 years later, with 18,000 engines having operated over 200 million hours. The 1980s saw the development of a family of engines, starting with the AE 1107 (T406) turboshaft on the V-22 Osprey. The core of this engine was used to produce the AE 2100 turboprop for a variety of military transport aircraft and the AE 3007 (F137). The AE3007 has gone on to power military, corporate and regional aircraft, including the unmanned Northrop Grumman Global Hawk, the rapid Cessna Citation X business jet (Fig. 22) and Embraer's successful ERJ 135/140/145 regional jets. Rolls-Royce's acquisition of Allison in 1995 gave it a firm foothold in the United States, introducing a complementary product line and strong engineering heritage. The arrangement has borne fruit, amongst others in the form of the LiftSystem for the F-35B variant of the Joint Strike Fighter, development in collaboration with GE of the F136 alternate engine for the F-35, as well as a crucial engineering contribution to the success of the latest Trent 1000–TEN variant.

Decades of intense competition and Rolls-Royce's philosophy of continuous development of excellent engineering products has seen it establish itself as a market leader in commercial aviation. Its products, ranging from the 300 shp RR300 turboshaft to the 97,000 lb thrust Trent XWB, set new standards in efficiency and reliability.

2.2 Speed

Through the evolution of the jet age, the emergence of the turboprop and high-bypass turbofan architectures has enabled the production of highly efficient gas turbines. However, these architectures rely fundamentally on a fan or propeller pushing large amounts of cold air, relatively slowly. This makes them unsuitable for high-speed or very-high altitude flight, thus



Figure 23. "Saddled to a skyrocket": the unique English Electric Lightning interceptor.

a divergence emerged in the product lines for all of the major jet engine manufacturers as they sought to power the latest combat aircraft ever higher, ever faster.

Rolls-Royce established itself in this market with its first axial flow jet engine, the Avon, developed from the AJ.65. As well as powering commercial aircraft, it also saw service in a number of military aircraft by de Havilland, Supermarine, Vickers and Saab. Particular mention must be given to its installation on the English Electric Lightning (Fig. 23), for which it was fitted with an afterburner. Described by pilots as "being saddled to a skyrocket", this astonishing Mach 2 interceptor still compares favourably in performance to fighters today, although it also showed an unmatched propensity for fuel consumption.

The 1950s and 1960s saw a rationalisation of the British aircraft engine manufacturers, with Armstrong-Siddeley and Bristol Aero Engines becoming Bristol Siddeley in 1959, then merging with the de Havilland Engine Company in 1961. Rolls-Royce subsequently acquired a cash-strapped Bristol Siddeley in 1966 (an acquisition which may well have contributed towards Rolls-Royce's later trouble financing the RB.211). This consolidation brought together companies with a proud heritage in aircraft engine design. Bristol Aero Engines, in particular, had established itself as Rolls-Royce's primary competitor through the 1930s and 1940s, based on the hugely successful radial engines designed by Roy Fedden, who was knighted in 1942 for his part. The combination of Rolls-Royce and Bristol Siddeley assembled the best of British engineering talent, multiple sites, technology and new product ranges. These additions also significantly strengthened Rolls-Royce's position in the defence market, where Bristol Siddeley under the great Stanley Hooker was on the way toward producing a series of iconic engines. Amongst these was the famous Pegasus engine for the Harrier, which brought vertical lift to the realm of combat jets – more on this later. Equally



Figure 24. The Olympus proved an outstanding match to the Concorde.

noteworthy was the Olympus (Fig. 24), the first twin-spool axial flow turbojet, which began life as a 9,000 lb thrust-class engine for the Bristol Type 172 (later cancelled) and Avro Vulcan. The engine saw off stiff competition from Rolls-Royce's Conway to power the Vulcan and went on to be the power plant of choice for a number of very different applications. The ultimate Olympus came in the form of the Rolls-Royce/Snecma Olympus 593, which powered the Concorde. The partnership with Snecma brought an advanced nacelle with a movable inlet, which enabled the engine to cruise at Mach 2 with unmatched efficiency. The Olympus was originally designed with growth potential up to 12,000 lb thrust in mind, which makes the 38,000 lb developed by the final production 593-610 version an all-the-more-astonishing achievement. The 12 Concorde aircraft in service clocked up more supersonic flying than all the world's military air forces added together during their 30-year service life.

Meanwhile, Armstrong-Siddeley's addition to the family brought the Viper with it: a small (approximately 1,000-3,000 lb thrust class) engine which began life as an expendable power plant for the Australian Jindivik drone. As requirements emerged for small engines of this type to power a variety of smaller trainer aircraft, the Viper was re-engineered as a multiple-use engine. This saw it encounter a number of reliability issues as some underdeveloped components were of limited life. Bristol Siddeley responded by introducing the first "power by the hour" programme on the DH 125 business jet, taking on the costs of non-routine maintenance and guaranteeing engine availability in return for a fixed hourly operating fee. This pioneering practise was the first in an industry-wide move away from the traditional time and material type contracts. The "power by the hour" commercial agreements benefit both the airlines, by reducing risk, fixing costs and enabling them to focus on their core business, and the manufacturers, who are incentivised to develop ever-more reliable products.



Figure 25. The Adour powered the SEPECAT Jaguar.

Further developments have followed, with real-time engine health monitoring enabling engine manufacturers to respond rapidly to problems and even pre-empt issues before they arise. The increasing amount of data generated by modern engines means that services are continuing to evolve, allowing airlines to plan routes and manage their assets to increase the efficiency of their operations. Rolls-Royce leads the industry in this regard with its TotalCare™, CorporateCare™ and MissionCare™ offerings for the civil, corporate and defence markets, respectively, and continues to explore new opportunities in collaboration with its customers.

Rolls-Royce's post-consolidation offerings for fast jets saw it partner with a variety of different companies to cater to different platforms. The Adour – a two-shaft, low-bypass turbofan – was jointly developed with Turbomeca in the late 1960s to power the SEPECAT Jaguar (Fig. 25). It was successful in this application and went on to power the BAe Systems Hawk trainer as well as its derivatives. The 1970s saw the RB199 emerge from a coalition with MTU and FiatAvio as the power plant for the Panavia Tornado. The Tornado's operational demands ranged from low-level, high-speed bombing to higher-altitude, long-endurance Electronic Combat Reconnaissance-type missions. This brought Rolls-Royce's expertise in large gas turbine design to play in a compact, modular three-spool turbofan which gave the aircraft truly all-round performance. The company strived to remain competitive in this domain with the mainly government-funded XG-40 demonstrator in the 1980s, which formed the basis for the EUROJET EJ200 powering the Eurofighter Typhoon. The EUROJET consortium formed in 1986, adding ITP in Spain to the Rolls-Royce/MTU/Avio marriage

that had successfully delivered the RB199. The twin-spool EJ200 delivered more power than the RB199 in a similar weight. This was key to the Typhoon's remarkable power-to-weight ratio and helped cement its position as a leading 21st century combat aircraft. A less successful story can be told of Rolls-Royce's later experience in the American market, where it partnered with General Electric to offer the F136 for the F-35 Joint Strike Fighter. It proved it would be a more capable engine than the competing Pratt & Whitney, F119-derived F135. However, its later arrival into the competition, along with budgetary constraints placed upon the challenging F-35 programme, saw its cancellation.

2.3 Vertical Lift – Helicopters to the F-35B

The domain of vertical lift has been a fruitful one for Rolls-Royce through the years, born of the ideas of visionary engineers across the Armstrong-Siddeley, Bristol and Rolls-Royce companies. The two domains of transportation and combat presented very different sets of requirements, which were eventually met through the turboshaft and a heavily modified turbofan, respectively.

The turboshaft journey is an altogether simpler proposition. In essence a jet engine with a shaft driving the helicopter blades through a gearbox, the fundamental design has followed that of the turbojet. Rolls-Royce began this journey through the Gnome (effectively a licence-built General Electric T58) and the Gem, a small, 1,000 shp de Havilland design which began development in the 1960s. This engine proved reliable in operations on the Westland Lynx and Agusta A129 Mangusta helicopters in an unusual triple-shaft design (Fig. 26). The acquisition of Allison brought with it the ubiquitous Model 250 (military T63) turboshaft, which has sold over 30,000 examples since its development in the 1960s, with 16,000 still in service today. Under Rolls-Royce, this has been recently developed into the RR300 and RR500 engines, which are designed to power the next generation of light helicopters and also offer a turboprop variant. Co-operation proved to be de rigueur in this domain, too, in particular with the formation of the LHTEC consortium between Allison and Honeywell to produce the T800/CTS 800 and a similar arrangement between Rolls-Royce and Turbomeca producing the RTM322, powering the AgustaWestland AW101 Merlin. The latest engine in this domain is the previously mentioned AE 1107 (T406) turboshaft, which powers the V-22 Osprey tiltrotor aircraft. Housed in wing-tip tilting nacelles, these help the V-22 combine the agility of a helicopter with the speed of a turboprop, making for a flexible platform for a variety of applications, in particular, casualty evacuation and battlefield special operations.

The combat jet segment has yielded a number of interesting vertical and/or short take-off and landing (V/STOL) developments over the last five decades. Initial efforts were centred on the development of light turbojets for the provision of direct vertical lift, as displayed by the Short SC.1 aircraft powered by the Rolls-Royce RB.108. The 1960s saw renewed focus on the concept of the V/STOL fighters. Several prototypes emerged, powered by the Rolls-Royce RB.162 – a simple, lightweight, turbojet designed for limited operation. This engine made use of glass fibre-reinforced plastics to achieve an impressive thrust-to-weight ratio of over 15:1, which is still a target for DARPA engines today (a joint Allison and Rolls-Royce design, the XJ99, was capable of 20:1). The French Mirage IIIV demonstrated Mach 2.0 flight and used eight of these to achieve vertical take-off, but its range and payload were heavily constrained by their weight. Meanwhile, the Germans had the Do 31 transport with four RB.162s housed in each of the outer nacelles (Fig. 27), as well as the VFW VAK 191B, which used two RB.162s to supplement a Rolls-Royce RB.193 turbofan (which itself bore some similarities to the Pegasus).



Figure 26. The Gem (foreground) powers the Agusta A129 Mangusta attack helicopter.

The British were eventually successful through the marriage of a Bristol engine to a Hawker airframe. Although Bristol had followed a similar route to Rolls-Royce with their lightweight BS.59 turbojet, under Stanley Hooker's stewardship they had also initiated studies of a large turbofan in the late 1950s, based on a combination of the Orpheus and Olympus turbojets – the BE.53. Sydney Camm of Hawker learned of this and invited Bristol to power his P.1127 V/STOL prototype, which was to become the Harrier (Fig. 28). The BE.53 in turn became the Pegasus engine, which had several novel features that made it particularly suited to this application. Vectored thrust was provided by two pairs of swivelling nozzles (two cold, two hot), which could be moved in unison to transition the aircraft from vertical to horizontal flight and vice-versa. When angled downwards, they formed a stable platform for the aircraft that enabled it to hover. The HP and LP spools were made to counter-rotate, negating each other's contributions to the engine's gyroscopic couple. Finer control was provided by bleeding off compressed air through reaction control valves to the nose, tail and wingtips. The engine and airframe were a success, entering service in 1969; after some teething problems, they proved



Figure 27. The unusual Dornier Do 31 had no less than eight RB.162 lift jets housed in the outer nacelles.

a capable and reliable platform. Following significant upgrades, the Harrier is still in service 50 years later in its McDonnell Douglas AV-8B guise with the US Marine Corps as well as the Italian and Spanish navies.

The Harrier's designated successor in the V/STOL role is the F-35B Joint Strike Fighter. The Lockheed-Martin F-35 design began in the mid-1990s as the X-35 prototype, the winner in a play-off between three concepts (others offered by Boeing and McDonnell Douglas). Rolls-Royce was on all three teams, being the only engine company with serious vertical-lift experience on the Harrier. The F-35 employs a completely different design approach to vertical lift to the Pegasus, which enables it to both fulfil its V/STOL role and travel supersonically – the latter being impossible due to the Pegasus's large fan, amongst other constraints. The F-35 has an innovative propulsion system, consisting of a relatively conventional military turbofan engine – the Pratt & Whitney F135 – combined with the Rolls-Royce LiftSystem® (Figs 29 and 30). The LiftSystem® is made up of a number of components: a driveshaft coming from the front of the F135 powers a large, vertically mounted, contra-rotating Rolls-Royce LiftFan® mounted behind the cockpit. A three-bearing swivel module (3BSM) on the exhaust directs the F135's thrust downwards to provide lift at the rear of the aircraft. Lateral stability is assured similarly to the Harrier through roll posts, which direct engine bypass air through the wings. The mounting of the large, 50-inch LiftFan® within the aircraft's fuselage enables the aircraft to maintain a sleek profile during conventional flight, allowing it to go supersonic. During vertical manoeuvres, the multi-plate



Figure 28. The Harrier required a large inlet to accommodate the huge volume of air sucked in by the Pegasus's fan.

carbon clutch engages to direct 29,000 hp to the two-stage LiftFan® delivering 20,000 lb of thrust, in itself almost as much as the final Pegasus engine. The LiftSystem® was awarded the Collier trophy in 2001, in recognition of the advances that it had brought to the domain of vertical lift. This propulsion system has since proven itself throughout the prototype and development programmes, with the F-35B reaching initial operational capability (IOC) in July 2015.

3.0 NON-AERO APPLICATIONS

The unrivalled power-to-weight ratio of the jet engine soon earmarked it as a potential source of power for other applications. Jet power has hence been harnessed throughout the ages for

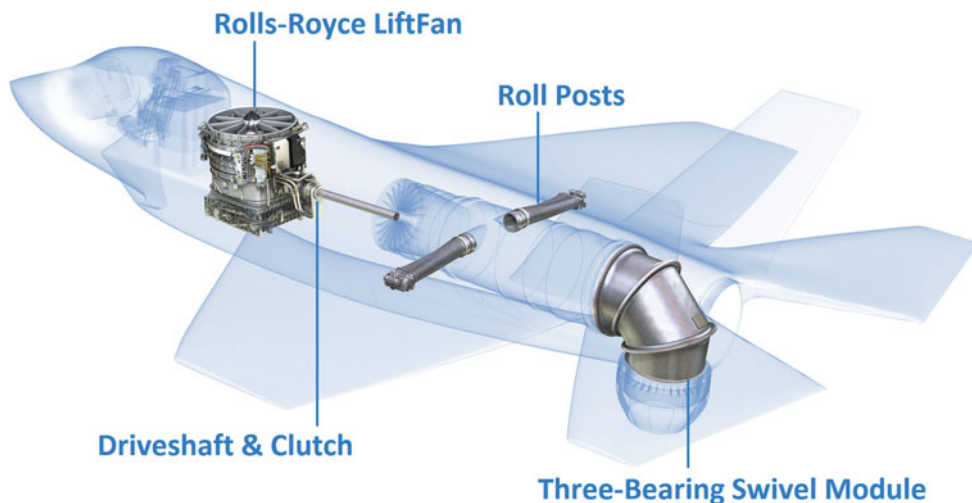

Figure 29. The Rolls-Royce LiftSystem[®], showing the three-bearing swivel module rotated downwards for vertical manoeuvres.

a variety of uses, including power generation, naval applications, land and water speed record attempts and even as airport runway snow blowers. Rolls-Royce has had a significant part to play as the reliability of its engines in the air translated to desirable characteristics on the ground and at sea. Several notable engines were developed through the years, making use of the gas turbine's rapid start time and throttle response characteristics as well as its unmatched power density.

The earliest such application for Rolls-Royce was the RM60, an experimental gas turbine designed for naval use. Installed on the HMS Grey Goose in 1953, a pair of RM60s provided 35% more power than the steam generators they replaced, in a package that was half the weight (Fig. 31). The experimental boat endured four successful years of trials, convincing the admiralty of the viability of gas turbine power at sea. This laid the foundation for Bristol's entry into the fray. The Bristol Proteus, a small turboprop engine, had already been converted in 1959 for use in pioneering, remotely controlled 2.7 MW 'Pocket Power Stations'. A decade on from the Grey Goose, 1967 saw a breakthrough when Britain's first large fully gas turbine-powered warship, the HMS Exmouth, took to the sea. The ship had been refitted with gas turbines in an effort to prove the new marinised Bristol Siddeley Olympus. She featured a single, de-rated Marine Olympus and two Proteus engines mated to a single shaft and despite early troubles proved to be a successful trial. The Olympus showed itself to be a robust, powerful design, going on to power ships from small frigates to aircraft carriers worldwide. It was often paired with the marinised Tyne, a smaller engine which was used for cruising.

The 16-17 MW Industrial Avon marked the beginning of Rolls-Royce's journey in power generation as a supremely reliable stationary power source for offshore rigs, pipelines and backup duties – including at nuclear power stations. It sold over 1,200 units and continues to operate to this day through a series of performance and life upgrades. This template was adopted with considerable success for the RB.211, which has sold 750 units in a variety of guises in the oil and gas and power-generation industries. Bookending Rolls-Royce's industrial engines were the smaller T56-derived Industrial 501 (introduced as early as 1963) and the larger 66 MW Trent-based Industrial Trent 60, the most advanced aeroderivative gas turbine to



Figure 30. The two-stage, contra-rotating LiftFan[®] provides vertical lift for the F-35B.

date. The same characteristics of ruggedness, reliability and performance retention that have made Rolls-Royce's engines a success with the airlines have spurred on sales in the power-generation market, until the sale of Rolls-Royce's Energy division to Siemens in December 2014 for commercial reasons.

Meanwhile, the waterborne legacy lives on through a similarly diverse product line offered by Rolls-Royce Marine, part of the company's Land and Sea division. There, the flexibility



Figure 31. The RM60 gas turbine enabled the HMS *Grey Goose* to reach speeds in excess of 35-kn.

and high power output of the gas turbines complements highly efficient reciprocating engines, powering vessels as varied as hovercraft to aircraft carriers.

4.0 AN EXCITING FUTURE

In order to remain competitive in an evolving, global marketplace, Rolls-Royce has continued its tradition of innovation, proving and de-risking new technologies through demonstrators and extensive development programmes. This has enabled the company to deliver safe, reliable, effective products which continuously evolve to meet the needs of the customers.

Rolls-Royce's approach to technology acquisition is summarised in the three-phase Vision Programme, which enables it to remain at the forefront of technology and innovation:

- Vision 5, with a five-year horizon, describes the application of proven “off-the-shelf” technology to existing engines, continuing Rolls-Royce's heritage of continuous development to ensure that they remain market leaders in every attribute.
- Vision 10, with a 10-year horizon, incorporates the technologies that are currently undergoing validation, with a view to introducing them in Rolls-Royce's next generation of engines.
- Vision 20, with a 20-year horizon, targets the future with strategic research programmes both internally and through our external technology centres, ensuring that Rolls-Royce remains at the forefront of progress.

These visions form the foundation for the next generation of products in what is an ever-more competitive industry.



Figure 32. Taranis, with a Eurofighter in the background
(Copyright © 2014 BAE Systems. All rights reserved).

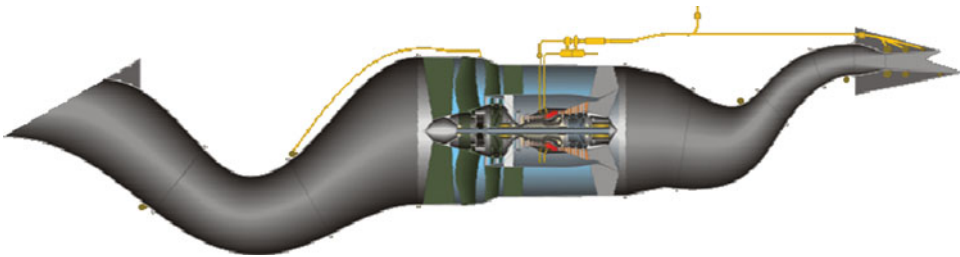

Figure 33. A single Adour engine was mounted inside Taranis. Complex ductwork for low observability poses complex integration challenges.

Defence has seen significant cuts in government spending, yet there is an increased focus on unmanned combat air vehicles (UCAV). These bring their own, different challenges in terms of the integration of compact, powerful engines into autonomous, intelligent platforms with low observability and increasing power demand. This requires the concealment of the engine within the fuselage through convoluted ductwork and innovative solutions such as embedded generators for the provision of large amounts of electrical power within a confined space. The BAE Systems Taranis first flew in 2013, demonstrating the feasibility of a stealthy UCAV (Fig. 32). Powered by an Adour, this proved a variety of low-observable technologies using advanced materials and manufacturing processes in a successful flight-test campaign (Fig. 33).

In the world of civil aerospace, global megatrends indicate relentless growth in air travel, posing severe challenges to the industry in terms of fuel consumption and emissions. In Civil Large Engines, the Trent 7000 has recently been launched, bringing the latest technology of the reliable Trent 1000 to power the re-engined A330neo, delivering 15% more fuel efficiency than the original Trent 700-powered A330. For the future, the Advance and UltraFan™ architectures are the foundation for the next generation of civil engines (Fig. 34).



Figure 34. Future architectures: Advance and UltraFan.

Advance (Vision 5) is the first departure from the proven RB.211/Trent architecture since the 1960s, with a change in work-split between the intermediate pressure (IP) and HP systems (more work being done by the HP system) making for an even more robust and efficient engine. Among the many benefits of the change are a lighter core with a higher pressure ratio (60:1), more robust air system and the relocation of the bearing chambers into cooler areas of the engine, reducing the oil cooling requirements. The core architecture is to be de-risked in a hybrid demonstrator based on a Trent XWB donor engine, which is intended to run for the first time in 2016. The testing of this architecture will provide Rolls-Royce and its customers with the confidence and technical data to underpin the next generation of engines.

The Advance core architecture also forms the basis for the future UltraFan (Vision 10), based on technology that could be ready for service in 2025. The UltraFan builds on the Advance core by adding high-temperature materials to push the pressure ratio to over 70:1. A new LP system is added with a power gearbox connecting the IP compressor to the extremely large and slow-turning carbon/titanium (CTi) composite fan. This enables a step-change in efficiency in a system architecture that is intended to be scalable to power a variety of future platforms. Further developments of the UltraFan could include the addition of a variable pitch mechanism to the fan, enabling the deletion of the thrust-reverser for a much lighter engine.

The change in architecture is underpinned by the introduction of new materials, in particular, the CTi fan system. The CTi fan is being demonstrated as part of the Advanced Low-Pressure System (ALPS) programme with flight testing supported by the EU Clean Sky programme. When implemented, the advanced composite fan system promises up to 750 lb reduction in weight per engine over the titanium set – the equivalent of around seven or eight passengers.

Advanced materials have paced the development of gas turbines throughout history, particularly in the engine's so-called "hot end". Rolls-Royce has continued to develop its turbines architecture through the introduction of increasingly capable materials and

technologies, with the HP turbine blade, in particular, evolving to meet the demands of ever-higher temperatures. Advance will see more capable ceramic matrix composite (CMC) materials and the next generation of nickel alloys, laying the foundations for future engine architectures.

The new architecture is completed by a lean-burn, low-emissions combustor which will allow future NO_x emission limits to be met with a considerable margin.

A key enabler of Rolls-Royce's innovation strategy has been the formation of a network of centres of excellence, both in academia and in industry. The company supports a network of 31 University Technology Centres (UTCs) worldwide, each addressing a key technology for future engines. These academic centres keep Rolls-Royce at the cutting edge of scientific research, and in doing so help to develop the next generation of engineers and researchers as they become experts in their respective fields. The UTC model is widely heralded as a very effective model for business and university cooperation; it has stood the test of time, with the earliest centres passing their 25th anniversary.

Manufacturing research has also seen exciting changes in recent years with the formation of a network of collaborative Advanced Manufacturing Research Centres (AxRCs), helping Rolls-Royce and other industrial partners develop their manufacturing capabilities in conjunction with lead universities. A network of seven centres has been brought together under the Innovate United Kingdom-funded High Value Manufacturing Catapult award. Rolls-Royce also collaborates with research bodies internationally in order to develop new technologies.

5.0 SUMMARY

The 150th anniversary of the Royal Aeronautical Society has seen Rolls-Royce become a global player in aerospace and a champion of British industry. Its products vary from the nimble RR300, powering two-seater helicopters, all the way to the 97,000 lb thrust Trent XWB powering future variants of the Airbus A350, and the MT30, which provides the propulsion for the Royal Navy's new *Queen Elizabeth* class aircraft carriers. It has built this range of products derived from the vision and innovation of its talented engineers, spurred on by the guiding principles provided by Henry Royce. This has seen it through times of war, hardship, bankruptcy, and fierce competition to emerge as the leading manufacturer of aircraft engines and a provider of power across land and sea. Alongside its products it has developed pioneering services to support its customers, analysing real-time data to improve the reliability and efficiency of its engines. In keeping with its tradition of innovation, the company is continuing to develop new products and services for the next generation of power systems for land, sea and air.

REFERENCES

1. CRAIGHEAD, I. *The Rolls-Royce Merlin 1933–50 (All Engine Models)*, 2015, Haynes.
2. HOWIE, D. *Rolls-Royce 1904–2004 a Century of Innovation*, 2004, Essential.
3. HUNT, R. The history of the industrial gas turbine (part 1 the first fifty years 1940–1990), *Power Engineer*, 2011, **15**, (2), paper 582.
4. JONES, G. *The Jet Pioneers: The Birth of Jet-Powered Flight*, 1989, London, UK, Methuen.
5. PUGH, P. *The Magic of a Name: The Rolls-Royce Story. Part 2: The Power behind the Jets*, 2001, Icon Books.

6. PUGH, P. *The Magic of a Name: The Rolls-Royce Story. Part 3: A Family of Engines*, 2002, Icon Books.
7. PUGH, P. *The Magic of a Name: The Rolls-Royce Story. The First 40 Years*, 2000, Icon Books.
8. RUFFLES, P.C. *The History of the Rolls-Royce RB211 Turbofan Engine*, 2014, The Rolls-Royce Heritage Trust.
9. ZIGMUNT, J. *Allison, the People and the Power: A Pictorial History*, 1997, Turner.