



The conceptual design of the high-efficiency 400 kW solid-state power station at 352 MHz for the European spallation source

Seyed Alireza Mohadeskasaei¹ and Dragos Dancila^{1,2}

¹FREIA, Department of Physics and Astronomy, Uppsala University, Uppsala, Sweden and ²Microwave Group, Department of Electrical Engineering, Uppsala University, Uppsala, Sweden

Research Paper

Cite this article: Mohadeskasaei SA, Dancila D (2024) The conceptual design of the high-efficiency 400 kW solid-state power station at 352 MHz for the European spallation source. *International Journal of Microwave and Wireless Technologies*, 1–7. <https://doi.org/10.1017/S1759078724000175>

Received: 25 August 2023
Revised: 10 January 2024
Accepted: 16 January 2024

Keywords:

advanced rugged technology; ART; cavity combiner; cavity splitter; solid-state power amplifier; SSPA

Corresponding author: Dragos Dancila;
Email: dragos.dancila@angstrom.uu.se

Abstract

This paper introduces an innovative conceptual design of a 400 kW solid-state power amplifier (SSPA) station and presents preliminary measurements for the key components. Recent advancements and benefits of solid-state technology have made the prospect of replacing vacuum tubes increasingly appealing. Historically, a significant challenge was the limited output power capacity of individual solid-state transistors, necessitating the integration of numerous units to generate high-power microwave signals in the range of hundreds of kilowatts. However, modern transistors capable of producing over 2 kW of output power have emerged, facilitating this transition. Another weak point was low power efficiency in high-power operating mode. The advanced rugged technology (ART) of solid-state devices enables the utilization of these transistors in nonlinear and switching operating classes, thereby enabling the creation of high-efficiency high-power amplifiers. In this conceptual design, 264 SSPA modules based on ART, each with a power output of 1.6 kW, are combined. The measurements revealed a single SSPA capable of delivering up to 2 kW output power with a power efficiency of 73% at frequency of 352 MHz. Due to the minimal losses during module combination and working SSPA in Class-C operation mode, the power efficiency of the station is expected to closely mirror that of a single module.

Introduction

The utilization of high-power microwave signals finds extensive applications in various industries, such as wireless communication, radio and television broadcasting, the medical field, applied physics, welding, heating, and research. Two conventional methods for generating these signals involve the use of vacuum tubes and solid-state semiconductor components. However, vacuum tubes come with significant drawbacks, including high maintenance costs, a limited lifespan, a lack of portability, a large DC power supply, etc. Consequently, the employment of solid-state technology has been rapidly expanding due to its advantages, including a high mean time between failure (MTBF) factor, high power efficiency, and compact size and volume. Recent studies have highlighted the feasibility of producing high-power and efficient amplifiers based on solid-state technologies such as GaN (gallium nitride) and LDMOS (laterally diffused metal oxide semiconductor). These advancements have facilitated the creation of solid-state ultra-power amplifier stations.

Moreover, the ever-growing capabilities of advanced rugged technology (ART) in solid-state devices have further enabled the deployment of high-power amplifiers in high-efficiency operating modes. Today, solid-state transistors with output powers exceeding 2 kW based on ART have been introduced to the market. As a result, by combining a limited number of these transistors, it becomes feasible to establish solid-state ultra-power stations with exceptionally high power levels in the range of hundreds of kilowatts.

In the design of a high-power solid-state station, a combination of several amplifiers with moderate power is essential. Therefore, two main considerations must be taken into account. Firstly, the construction of amplifiers with optimal specifications, such as high output power, high efficiency, and high gain. Secondly, the manner in which these amplifiers are combined using a combiner with very low insertion power losses.

Typically, to construct a high-efficiency amplifier with optimal characteristics, among linear classes, Class-C is recommended. In this operating class, in the case of a proper matching network, the amplifier efficiency theoretically depends on the conduction angle and quiescent bias point. Furthermore, if the utilized transistor possesses a high breakdown voltage, increasing the input signal can lead to even higher efficiency since the overlapping between drain voltage and current signals is reduced. In this design, we employed an LDMOS transistor based on Advanced Rugged Technology with the part number ART2k0FE of Ampleon in Class-C operating mode and utilized an amplifier with a peak power level of

© The Author(s), 2024. Published by Cambridge University Press in association with The European Microwave Association. This is an Open Access article, distributed under the terms of the Creative Commons Attribution licence (<http://creativecommons.org/licenses/by/4.0>), which permits unrestricted re-use, distribution and reproduction, provided the original article is properly cited.

1.9 kW and 73% power efficiency. Eventually, 264 SSPAs are combined using four very low-loss cavity combiners and a progressive combiner, providing 400 kW at the output.

The structure of this paper is as follows: it begins with a brief overview of the state of the art, followed by a concise description of the implemented amplifiers in the FERIA laboratory. Subsequently, the specifications of the proposed 400-kW solid-state power amplifier (SSPA) for the ESS are presented. Additionally, the next section of the paper covers the specifications of the 2-kW SSPA, high-power cavity combiner, power cavity splitter, monitoring and interlock control units, and DC power supply. The article concludes with a summary of the findings.

An earlier version of this paper was presented at the Swedish Microwave Days 2023 Conference and was published in its proceedings [1].

State of the art of high power solid state power amplifiers stations

Radio frequency (RF) solid state power amplifiers (SSPA) offer many advantages compared to vacuum tube technology, such as: (i) longer lifetime and longer MTBFs considering more than 10 years of operation 24/7, (ii) additional safety as the voltage power supply is much lower i.e. 50 V vs. 16 kV for a tetrode tube, (iii) additional redundancy in operation by combining multiple SSPAs, (iv) benefiting from an established and expanding semiconductor industry, contrasted with vacuum tube manufacturers grappling with technological obsolescence and a dwindling supplier pool, (v) SSPAs outshine vacuum tubes, capitalizing on the advantage of an extended operational lifespan. While vacuum tubes, including tetrodes at 352 MHz and nominal power levels of 200 kW are considered to have a typical lifetime of 5000 h, klystrons are considered to last about 10,000 h, and thus exhibit comparatively limited typical lifetimes, while SSPAs extend their lifetime up to 100,000 h.

But still, the output power of SSPAs is relatively low and many SSPAs need to be combined in order to produce the peak power levels required. A pioneering work in using SSPA for high-power applications started in 2014 at SOLEIL with a high-power amplifier at 352 MHz combining for the first time many MOSFET modules of 330 W for the 40 kW for their booster amplifier, then 2×180 kW for the storage ring and demonstrating extremely high reliability [2]. After the first transfer of technology to the industry, i.e. from SOLEIL to ELTA, seven high-power amplifiers of 150 kW were realized at ESRF [3]. Utilizing a cavity combiner architecture to implement power combination with minimized insertion losses plays a pivotal role in ensuring the cost-effectiveness of a system of this magnitude. This approach was executed through the creation of a prototype cavity combiner at ESRF as a cavity combiner with a 144:1 combination ratio [4]. Solid state high power amplifier technology is now increasingly proposed commercially by an increasing number of industrial suppliers (e.g. THALES pulsed SSPAs at 200 MHz for CERN/SPS, IBA SSPA at 176 MHz for MYRRHA, Rohde & Schwarz for MAX IV and Solaris, Cryoelectra for BESSY, Ampegon for PSI at 500 MHz and many others [5]). Despite the successful implementation of SSPA at many accelerator labs, for each new accelerator project, the choice between solid-state technology and vacuum tubes is still debated. A major leap forward comes from CERN, where 200 MHz tetrodes are presently replaced by SSPAs for the upgrade of the acceleration system of the super proton synchrotron (SPS). The transistors are assembled in sets of four modules that supply 2 kW, and a total of 2560 modules,

i.e. 10,240 transistors are spread across 32 cylindrical towers. The whole system provides RF power of two times 1.6 MW. Hence, a crucial factor is the economical efficiency per watt, enabling the SSPA solution to secure the contract at CERN [6]. In addition, such a system is much more flexible, since the power is distributed across thousands of transistors. If a few transistors stop working, the RF system will not stop completely, which will be the case with a vacuum tube-based station.

SSPA development at FREIA

The FREIA Laboratory is part of the Department of Physics and Astronomy at Uppsala University. It has more than 30 employed researchers, engineers, and technicians. The scientific goal of the Laboratory is to enable new leading experimental investigations in particle and nuclear physics, atomic and molecular physics, chemistry, molecular biology, and material, energy, and environmental science. The main equipment of the FREIA Laboratory currently includes a high-capacity helium liquefier, a large horizontal and a vertical cryostat, two 400 kW vacuum-tube RF sources, advanced hard- and software for process control and safe test bunkers, allowing for tests of superconducting high-power equipment like magnets and superconductive accelerating cavities. The FREIA Laboratory is located in a 1000 m² large, 10 m high hall forming part of the Ångström Laboratory in Uppsala [7].

The two 400 kW RF stations at 352 MHz were commissioned and installed by the industry. One manufactured by Iteco-Electrosys [8] was commissioned in 2015 [9] and the other one was manufactured by DB Science and commissioned in 2016 [10]. The stations were used for testing spoke cryomodule prototypes for ESS. Unfortunately, multiple issues with both RF stations delayed or inhibited normal operations. The tetrodes have shown certain reliability issues and the new version of the vacuum tube, i.e. the TH595A (in replacement of the TH595) still has to prove its reliability. But the most worrying for the future operations of ESS is that we have only one vacuum tube manufacturer worldwide supplying such vacuum tubes, which will pose serious supply issues. Recently prices are up by 40% with half year lead-time for orders. The future of these tubes is not guaranteed as the market is shifting towards solid-state technology.

At the FREIA Laboratory, we have pursued the development of SSPA technology considering ESS specifications. The ongoing collaboration with ESS resulted in several publications on a compact 10 kW solid-state RF power amplifier at 352 MHz [11], with a total output peak power of 10.5 kW. The amplifier combines 8-kW level SSPA modules, built around a commercially available LDMOS transistor in a single-ended architecture, each module characterized by an efficiency of 71% in pulsed operation [12]. A feedback-controlled RF power flatness compensation at a 10 kW level was also demonstrated [13].

Other results are related to the advancement of high-power combiners operating at the 100 kW scale. Notably, a non-resonant 12-way radial combiner was designed, fabricated, and evaluated at FREIA, revealing outstanding uniformity in merging high power and showcasing an insertion loss of 0.1 dB. Elaborate electromagnetic and thermal simulations of this combiner, operating within a combination scheme aligned with ESS specifications of 400 kW at 352 MHz, are offered. In the initial stage, power combination is achieved at the 100 kW level utilizing the 12-way radial combiner, envisaged to combine 12×8 kW solid-state amplifiers. Subsequently, a waveguide combiner featuring T-shape couplers separated by a half-wavelength of the fundamental waveguide

mode is introduced in the second stage to combine the power to the 400 kW [14]. An updated iteration of the radial combiner, exhibiting even lower insertion loss and a more compact footprint, was effectively demonstrating its efficacy up to 200 kW pulsed RF power [15].

More recently, we demonstrated a new strategy for charging superconductive cavities in pulsed mode with SSPAs. The power applied during the charging phase is modulated to improve the energy efficiency of the overall system. This was demonstrated at the module level and higher energy efficiency for SSPA with envelope tracking (ET SSPA) is foreseen, in comparison to other methods of powering superconductive cavities [16, 17]. Actually, a conventional procedure for charging those cavities is using a step charging profile. But, during the initial filling time, the superconductive cavity behaves as a mismatched load and a large amount of power is reflected until the electrical field reaches a nominal value. The latest developments are presented in [18, 19].

400 kW SSPA station specifications for ESS

The SSPA station is designed to have an overall high wall plug efficiency of over 65%, a small total footprint area of 4 m², and a duty cycle of 10%. The design ensures compatibility with the existing infrastructure at ESS, particularly with the 400 kW vacuum-tube power stations, and especially has the same footprint, thus having eight stations fit within the total available footprint of 10 m × 11 m at ESS, as shown in Fig. 1.

To fulfill these specifications, the development of a high-power amplifier module boasting a capacity of at least 1.5 kW and with a high efficiency of about 70% is necessary. This is achieved by leveraging cutting-edge transistor technology, in LDMOS and GaN semiconductor technology, ensuring both efficiency and reliability.

In addition, the design of a high-power combiner requires a trade-off between low insertion loss and practical implementation. A simple calculation, considering 0.3 dB insertion on the high-power combiner results in an overall efficiency of 65% for the whole station.

A good example of a low insertion loss combiner is the cavity combiner with a large number of input ports. Alternative solutions provide a relatively lower combination ratio, i.e. 64:1 at 100 kW level, and a second step of combination, at a higher power level i.e. a 4:1 at 400 kW level. As the whole station is composed of a number of lower power amplifiers, the potential for phase imbalances among power amplifiers is there, before their combination at the nominal power. Thus control mechanism or a calibration step needs to ensure harmonized phase and amplitude across the system, thus optimizing the overall performance.

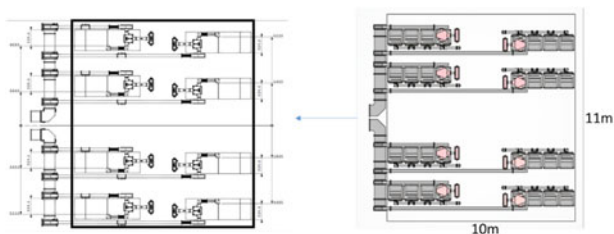

Figure 1. The SSPA station's footprint (right) is designed to be compatible with the existing 400 kW vacuum-tube RF power stations (left), fitting within the total available footprint at ESS of 10 m × 11 m.

Description of the 400 kW SSPA station

At the FREIA laboratory, in close collaboration with ESS and Swedish industrial partners, we are implementing the first pilot RF power station delivering 400 kW nominal power. This is composed of 256 high-power SSPAs, each delivering about 1.6 kW. The modules are combined in a two-step architecture, i.e. using a 4:1 combiner at 400 kW level and four 64:1 at 100 kW level combiners, as illustrated in Fig. 2.

As part of the conceptual design, several ideas were considered, one of which entails the possibility of implementing more amplifier modules than needed and employing 256 amplifiers among the larger number of modules, to bring the station a nominal power level. The installed spare modules will then only be connected when a failure of one active module appears, as a way to increase redundancy and MTBFs. However, the additional complexity of this implementation resides in the need for a hot-swap commutation system of the modules, increasing the complexity and cost of the station. Therefore, the station is implemented in a simpler configuration with only the nominal number of SSPAs installed, i.e. 256, a two-step architecture, with a 4:1 combiner at the 400 kW level and four 64:1 100 kW combiners, with very low insertion loss per stage, i.e. in the order of 0.15 dB per stage.

The design is compatible with the existing Spoke RF power station, thus using the coaxial circulator in place. A 400 kW circulator is provided with a coaxial flanged 400 kW AFT circulator and RG2300HH water-cooled load, both are already available on-site at ESS. There is no circulator planned per SSPA module, as the 400 kW station will only be operated with the 400 kW circulator, thus testing full reflection at the module level is not necessary.

The possibility of changing the amplitude and phase in front of each SSPA module would make it possible to compensate for possible imbalances and compensate for both static phase shifts due to cable length variations and dynamic operational variations. Those imbalances induced by temperature variations could be compensated using machine learning control techniques, optimizing the operation at high power. However, a simpler architecture

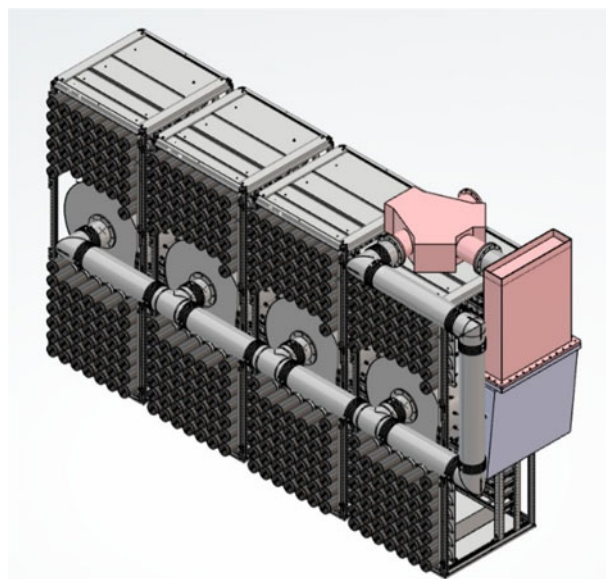

Figure 2. 3D view of the solid state power amplifier station at 400 kW.

was adopted, where only the phase and amplitude per rack of 100 kW is compensated.

Amplifier module

The architecture of the SSPA station's amplifier modules revolves around a commercially available LDMOS transistor, implemented within a single-ended architecture, see Fig. 3. The prototype SSPA module employs the LDMOS transistor ART2K0FE, harnessing Advanced Rugged Technology (ART) to cater to applications spanning ISM, broadcast, and communications across the 1–400 MHz frequency spectrum. This module prototype showcases a noteworthy power output of 1.6 kW with an efficiency of 73%, see Fig. 4. Notably, the potential to elevate the power output to 1.9 kW is possible through the adjustment of the drain voltage, a capability that can be leveraged during station operation. The module design integrates N-type connectors for packaging, along with the standardization of DC feeding connectors. This approach further facilitates the amplification of the module's output power to higher levels, such as 1.9 kW, by incrementing the drain voltage, for instance, up to 70 V. The driver transistor is implemented using the ART35, which is also based on the same ART technology and could deliver up to 35 W. There is no circulator planned per module, as we will operate the 400 kW station with a circulator at 400 kW level.

Power combiner architecture at 100 kW level

The SSPA modules are combined using a two-step architecture, involving a 4:1 combiner at the 400 kW level and four 64:1 100 kW combiners. The need to increase the overall efficiency of the 400 kW station translates into reducing combination losses. Thus, we developed a 64:1 cavity combiner combining 64 SSPAs with

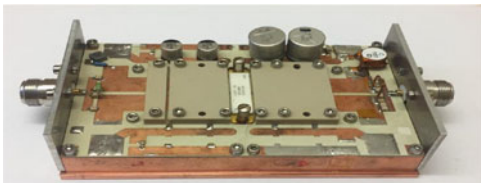

Figure 3. Illustration of the single-ended SSPA module at 352 MHz.

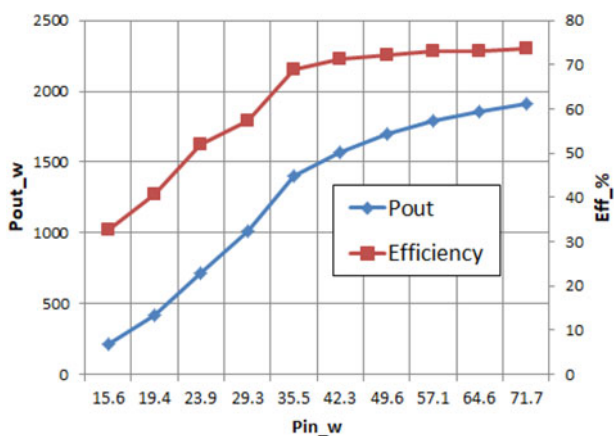

Figure 4. Measured drain efficiency and output power as a function of the input power.

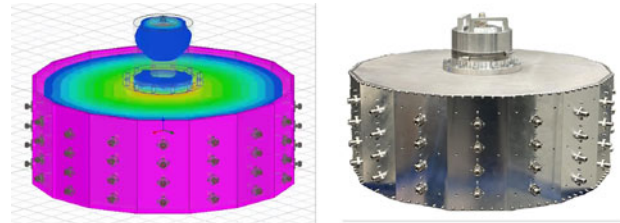

Figure 5. Power combiner with the illustration of the electrical field and the manufactured prototype.

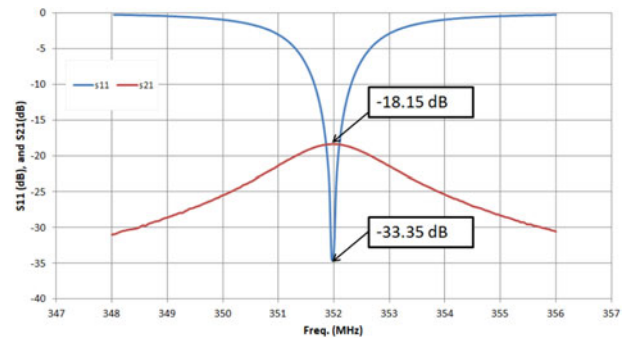

Figure 6. Measured S parameters of the power combiner at 352 MHz. The insertion loss is about 0.15 dB.

high efficiency till 100 kW level, see Fig. 5. This was inspired by the work in the EU project FP7/ESFRI/CRISP, where ESRF developed and built the first cavity combiner that combines the power from 132 SSPAs in one step and delivers up to 90 kW in CW at 352 MHz. The technique was later applied for the implementation of 1.6 MW pulsed SSPA for the upgrade of the 200 MHz RF system of the SPS at CERN. The cavity combiner turned out to be an extremely cost-effective, highly compact, and energy-efficient alternative to other combining techniques.

The insertion loss of our power combiner was around 0.15 dB at 352 MHz, as could be seen from Fig. 6. The ability to adjust the resonant frequency for each combiner is implemented as a plunger, which allows to compensate for imbalances and variations at a calibration stage.

Power splitter architecture

The splitter has a slim form factor in comparison to the combiner as the field is lower, which allows for a denser construction, see Fig. 7. The input is connected to an isolated combiner that uses four 1.6 kW modules, providing an additional degree of redundancy. As a result, a maximum of 94 W is available, which is however sufficient, as the actual input power needed is 50–70 W. The measured S parameters of the power splitter at 352 MHz. The insertion loss is about 1 dB, see Fig. 8.

Central monitoring and control unit

We have established a clear understanding of the control and monitoring unit, utilizing a communication protocol such as EtherCat. Our goal is to adjust the drain voltage per power level to ensure amplifier efficiency for different output power levels. Additionally, we need to centralize the monitoring of interlocks and enable external communication. Finally, we address the need to balance the

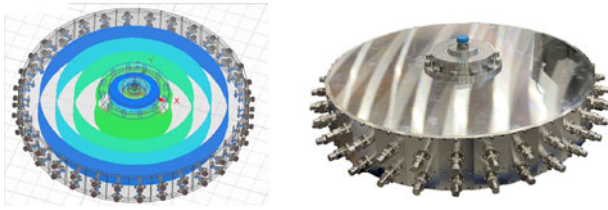

Figure 7. Power splitter with the illustration of the electrical field and the manufactured prototype.

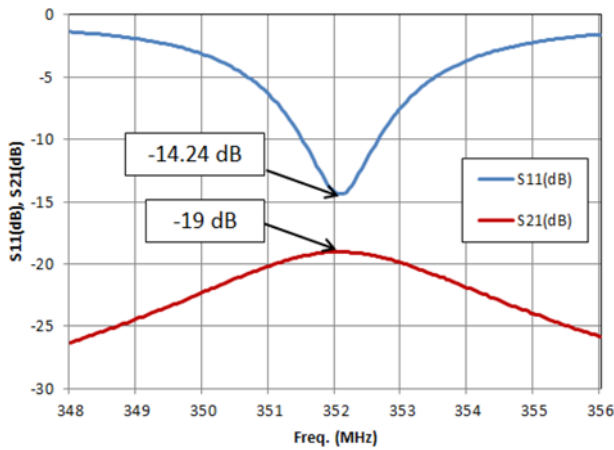

Figure 8. Measured S parameters of the power splitter at 352 MHz. The insertion loss is about 0.15 dB.

four 100 kW racks. Thus, to control the phase and amplitude of the driving signals, we have only one control board per rack. The boards enable calibration and a balancing of the amplifiers, which are combined by a non-isolated combiner, a 4:1 tapered coaxial line combiner at 400 kW. The latest is sensitive to amplitude and phase imbalances and thus needs to be properly configured, see Fig. 9.

During the commissioning stage, phase shifters are also installed to compensate for any phase imbalances. In order to enhance the overall output power, we establish an optimum phase shift and amplitude attenuation per rack. These boards are connected to a central unit and follow commands from it, as described

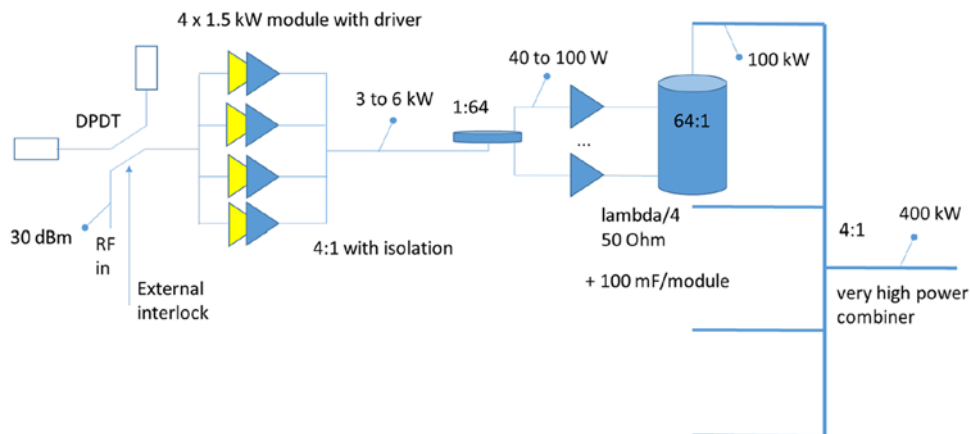

Figure 9. Schematic of the solid state power amplifier station at 400 kW.

below. Calibration of the amplifier racks at the system level is necessary to achieve balance. The central unit includes a calibration function that adjusts the phase and amplitude per rack to optimize the overall output power. Initially, two racks are connected to the combiner, and the phase and amplitude of the second rack are adjusted until the maximum output power is obtained. Then, a third and fourth rack are connected, and a similar procedure is followed to determine and apply the correct settings of phase and amplitude, which constitutes the calibration process. During operation, a monitoring function is implemented to ensure that the phase and amplitude are continuously adjusted to maintain a good balance among the four racks.

In addition, the DC power supply is also connected to the monitoring and control system, enabling the adjustment of the drain voltage at different power levels. Furthermore, a monitoring system is in place to check the operation of the four racks of 64 modules each, verifying the drain voltage per module and centrally reporting any issues.

Interlocks

An interlock system is an essential safety feature in any RF amplifier system. It works by monitoring various parameters of the system to ensure that they remain within safe limits. If any of these parameters exceed their safe limits, the interlock system will shut down the system automatically to prevent damage or injury.

One of the most important parameters to monitor is the RF on/off status. This is necessary to prevent the amplifier from operating when it is not supposed to, as it can cause damage to the system or even injury to personnel. The interlock system monitors the RF on/off status and ensures that the amplifier only operates when it is supposed to.

Another important parameter to monitor is the water cooling system. The interlock system should be able to detect any problems with the water cooling system, such as a leak or low water flow, and shut down the amplifier before it overheats. This is important to prevent damage to the amplifier and ensure safe operation. The DC voltage is also a crucial parameter to monitor in an amplifier system. The interlock system should be able to detect any voltage spikes or drops and shut down the amplifier if necessary. This is important to protect the system from damage and ensure safe operation.

DC power supply dimensioning

A comprehensive analysis was conducted based on the given specifications, resulting in the following insights initially considering a system comprising 70 amplifier modules, each rated at 1500 W, boasting an efficiency of 70%. This translates to a power consumption of 2143 W per module, cumulating at a total power demand of 150 kW for all modules. A distinct power consumption pattern is observed, with a total period of 35 ms. During the initial 3.5 ms interval, the system draws the complete power requirement, while the subsequent 31.5 ms period is dedicated to recharging. The power supply furnishes a continuous output of 70 V and 215 A, yielding an impressive power output of 15 kW. Delving into the specifics, the energy storage elements, i.e., the 70 capacitors, are charged to a voltage of $V_1 = 70$ V, resulting in a stored energy of 166.6 J per capacitor. The cumulative capacitance of 4 760 mF facilitates an energy storage capacity of 11.6 kJ. The initial 3.5 ms phase witnesses a discharge of energy from the capacitor bank, amounting to 472 J. Consequently, after this duration, the remaining energy stands at 11.2 kJ, corresponding to a voltage of $V_2 = 68.57$ V. Further analysis indicates an average power demand of 15 kW over the entire 35 ms period. This assessment underscores the viability of a well-dimensioned 15 kW unit, ensuring optimal performance. Furthermore, incorporating a redundant unit could provide enhanced reliability and operational robustness. For optimal efficiency and performance, a centralized voltage control mechanism is recommended. The system exhibits the capability to dynamically adjust the voltage within the range of 40–70 V during operation, thereby achieving an ideal balance between power efficiency and operational stability.

Conclusions

The presented research showcases the evolution from traditional vacuum-tube technology to SSPAs, capitalizing on the benefits of reduced operational lifespans of vacuum tubes, ultimately leading to enhanced system reliability and cost-effectiveness. This transition is particularly pertinent considering the challenges posed by the obsolescence of vacuum tube technology and the subsequent reduction in suppliers.

The development of the 400 kW SSPA station is driven by the need for optimized power delivery at 352 MHz. The utilization of commercially available LDMOS transistors, combined with a single-ended architecture, has yielded SSPA modules with an efficiency of 73% and delivering up to 1.9 kW peak power. The design's adaptability allows for power enhancement through voltage adjustments, adapting to specific operational requirements.

Efforts have been made by the necessity to address phase imbalances that may arise among power amplifiers. This is imperative for achieving optimal performance, and adaptive control mechanisms are explored to ensure harmonious operation across the system.

Key achievements also encompass the implementation of power combiners with reduced insertion losses. This advancement significantly contributes to the economic competitiveness of systems operating at this scale, enabling seamless power combining while maintaining efficiency. These combiners play an instrumental role in realizing the 400 kW pulsed power station.

In conclusion, SSPA solutions at very high power continue to push the boundaries of efficiency, reliability, and adaptability, as a robust replacement for vacuum-tube counterparts, fostering innovation in accelerator technology and beyond. The future plan is to

collaborate with ESS on the implementation of the first prototype of the station.

Acknowledgements. The authors would like to thank Vincent Halo for the 3D drawings.

Funding statement. This work was supported by the Swedish Research Council, under a grant for investment in existing research infrastructure (grant number 2021-00329).

Competing interests. The authors report no conflict of interest.

References

1. Mohadeskasae SA and Dancila D (2023) Preliminary conceptual design of the 400 kW Solid-State Power Amplifier station for ESS. In *SMWD 2023*, 23–25 May, KTH Royal Institute of Technology, Stockholm.
2. Marchand P, Lopes R, Ribeiro F and Ruan T (2011) Development of high RF power solid state amplifiers at SOLEIL. In *IPAC2011*, 4th–9th September 2011, San Sebastián, Spain. MOPC127.
3. Jacob J, Mercier J-M, Langlois M and Gautier G (2011) 352.2 MHz–150 kW solid state amplifiers at the ESRF. In *IPAC2011*, San Sebastián, Spain. IPAC.
4. Technical Note for CERN-LIU-SPS (2013) CRISP, 2nd Yearly Meeting, PSI, 18–19 March.
5. MYRRHA Project. <https://www.sckcen.be/en/infrastructure/myrrha>
6. Montesinos E (2022) CERN SPS RF SSPA, from design to operation. In *Twelfth CW and High Average Power RF Workshop*, 12–14 September, CERN, Geneva, Switzerland.
7. Ruber R, Bhattacharyya A, Dancila D and Ekelöf T (2021) Accelerator development at the FREIA Laboratory. *Journal of Instrumentation* 16(7).
8. Padamsee H (2014) Hadron Polarizabilities. *Annual Review of Nuclear and Particle Science* 64, 175.
9. Jobs M, Wedberg R and Gajewski K (2015) *Itelco-Electrosys 400 kW RF Station Site Acceptance Test*. Uppsala: Department of Physics and Astronomy, Uppsala University.
10. Jobs M, Wedberg R and Gajewski K (2017) DB science 400 kW RF station site acceptance test.
11. Dancila D (2017) A compact 10 kW solid-state RF power amplifier at 352 MHz. *Journal of Physics: Conference Series* 874, 012093.
12. Haapala L, Eriksson A, Hoang LD and Dancila D (2016) Kilowatt-level power amplifier in a single-ended architecture at 352 MHz. *Electronics Letters* 52(18), 1552–1553.
13. Hoang Duc L, Jobs M, Lofnes T, Ruber R, Olsson J and Dancila J (2019) Feedback compensated 10 kW solid-state pulsed power amplifier at 352 MHz for particle accelerators. *Scientific Instruments* 90(10).
14. Goryashko VA, Dancila D, Rydberg A and Ruber R (2014) A mega watt class compact power combiner for solid state amplifiers. *Journal of Electromagnetic Waves and Applications* 28(18).
15. Goryashko VA (2018) 12-Way 100 kW reentrant cavity-based power combiner with doorknob couplers. *IEEE Microwave and Wireless Components Letters* 28(2), 111–113.
16. Hoang Duc L, Bhattacharyya A, Olsson J and Dancila Dragos (2018) Optimal power consumption during the charging of superconducting cavities using drain voltage modulation of solid-state power amplifiers. In *GigaHertz Symposium*, 24–25 May, Lund.
17. Bhattacharyya AK (2015) Minimization of power consumption during charging of superconducting accelerating cavities. *Nuclear Instruments and Methods in Physics Research Section A: Accelerators, Spectrometers, Detectors and Associated Equipment* 801(Supplement C), 78–85.
18. Hoang Duc L and D Dancila (2023) Preliminary results of envelope tracking linearization of solid-state RF power amplifiers for efficient superconducting cavity charging. In *SMWD 2023*, 23–25 May, KTH Royal Institute of Technology, Stockholm.
19. Hoang Duc L and Dancila D (2023) An advanced solid-state RF power source maximizing energy efficiency for optimal superconducting RF cavity charging. *International Journal of Microwave and Wireless Technologies*.



S. Alireza Mohadeskasaei is a Microwave Engineer with more than a decade of experience in the field. He earned his Bachelor's and Master's degrees in Electronic Engineering in 2003 and 2006, respectively. From 2008 to 2013, he worked as a Microwave Engineer at Isfahan University of Technology. In 2013, Alireza pursued further research opportunities by enrolling as a Ph.D. candidate at the University of Science and Technology in Beijing, China. He successfully completed his Ph.D. in 2017 and was recognized as an outstanding international student. Following the completion of his Ph.D., he applied for and received grants from the Marie Skłodowska-Curie Action of the European Union and Vinnova in 2020. In September 2021, he joined Uppsala University as a Marie Curie researcher. Currently, Dr. Mohadeskasaei conducts research on several microwave circuits including high-power solid-state amplifiers, splitters, and combiners in Uppsala University, Sweden.



D. Dancila completed his Ph.D. in Microwave Engineering at the Université catholique de Louvain in 2011, focusing on research related to RF-MEMS and microfabrication technologies for millimeter-wave components, which was conducted at IMEC in Belgium. Since March 2019, he has held the position of Associate Professor at Uppsala University, where he currently teaches courses in electronics and microwave engineering. His research activities within areas such as millimeter-wave antenna arrays and reflectarrays, RF sensors, and high-power highly efficient RF and microwave amplifiers at the FREIA laboratory. In addition to his academic achievements, Dr. Dancila possesses a formal education in Business Management, which he acquired from the Solvay Business School in Brussels. He has also founded the spin-off company Percy Roc AB, with a primary focus on material processing utilizing high-power microwave technology.