

NEW RESULTS FOR THE LINEAR STABILITY OF THE TRIANGULAR POINTS IN THE ELLIPTIC RESTRICTED PROBLEM

R. Meire

Astronomical Observatory, Ghent State University,
Ghent, Belgium.

ABSTRACT. New results are obtained for the linear stability of the triangular points in the elliptic restricted problem using the Hill equations which describe the infinitesimal motion around L_4, L_5 . Also the shape of the 4π -periodic solutions along the transition curves in the μ - e plane is investigated .

1. INTRODUCTION

The stability of the triangular points in the elliptic restricted three-body problem has been the subject of many papers in the sixties and seventies (Danby, Bennett, Tschauner among others). In these papers the eigenvalues of the dynamical system were investigated to determine the transition curves which separate stable and non-stable regions in the μ - e plane. Here the approach is somewhat different. The equations of motion around L_4, L_5 can be written as a set of two Hill equations and we will use some theorems for this type of equations in order to obtain analytical stability conditions.

In a second part of this paper, we will investigate the 4π -periodic solutions which exist along the transition curves. It will be shown that the shape of these curves can be completely explained by analytical means.

2. EQUATIONS OF MOTION

The plane motion around the triangular points L_4, L_5 in the elliptic restricted problem is given by the equations (see Tschauner) :

$$\begin{cases} x'' - 2 y' = r c_1 x \\ y'' + 2 x' = r c_2 y \end{cases} \quad (2.1)$$

where

$$r' = \frac{d}{dv} \quad (v = \text{true anomaly})$$

$$r = (1 + e \cos v)^{-1}$$

$$c_i = \frac{3}{2} [1 + (-1)^i \cdot \sqrt{1 - g}] \quad (i=1,2)$$

$$g = 3\mu(1 - \mu)$$

The two parameters e and μ determine the stability or instability of the equations (2.1). Stability investigations on this 4-th order system have been done by Danby and Bennett among others.

Tschauner succeeded in separating the 4-th order system (2.1) into two independent 2-nd order systems :

$$\begin{bmatrix} y_1 \\ y_2 \\ \star \\ y_1 \\ \star \\ y_2 \end{bmatrix}' = \begin{bmatrix} P_1 & 0 \\ 0 & P_2 \end{bmatrix} \cdot \begin{bmatrix} y_1 \\ y_2 \\ \star \\ y_1 \\ \star \\ y_2 \end{bmatrix} \quad (2.2)$$

or

$$\begin{cases} Y' = P_1 Y & (2.3a) \\ Y^{\star}' = P_2 Y^{\star} & (2.3b) \end{cases}$$

with

$$Y = \begin{bmatrix} y_1 \\ y_2 \end{bmatrix} \quad \text{and} \quad Y^{\star} = \begin{bmatrix} y_1^{\star} \\ y_2^{\star} \end{bmatrix}$$

Furthermore, we have the following relations between the old and the new variables

$$\begin{cases} x = y_1 + y_1^{\star} \\ y = y_2 + y_2^{\star} \end{cases}$$

and the (2 x 2)-matrices P_1 (1=1,2) are given by their elements $p_{ij}^{(1)}$

$$p_{11}^{(1)} = p_{11}^{(2)} = -\frac{1}{2} r e \sin v (1 + k e \cos v) \tag{2.4a}$$

$$p_{22}^{(1)} = p_{22}^{(2)} = -\frac{1}{2} r e \sin v (1 - k e \cos v) \tag{2.4b}$$

$$p_{12}^{(1)} = p_{12}^{(2)} - \frac{rc}{2} = r (a_2 + e \cos v - \frac{1}{4} k e^2 \cos 2v) \tag{2.4c}$$

$$p_{21}^{(1)} = p_{21}^{(2)} + \frac{rc}{2} = -r (a_1 + e \cos v + \frac{1}{4} k e^2 \cos 2v) \tag{2.4d}$$

where

$$k^2 = (1 - g)^{-1}$$

$$c^2 = 1 - 9g + 2e^2 + k^2 e^4$$

$$a_i = \frac{1}{4} (2c_i + 1 - c) \quad (i=1,2)$$

Another important aspect of Tschauner's work is that the curve $c = 0$ corresponds to one of the transition curves obtained (numerically) by Danby and Bennett using the equations (2.1).

Instead of using the 2-nd order equations (2.3) we can also transform them into a set of two Hill equations. We obtain (see Meire 1980) :

$$\left\{ \begin{aligned} \xi_1'' + J_1(v) \cdot \xi_1 &= 0 \end{aligned} \right. \tag{2.5a}$$

$$\left\{ \begin{aligned} \xi_2'' + J_2(v) \cdot \xi_2 &= 0 \end{aligned} \right. \tag{2.5b}$$

with

$$J_1 = - \left\{ r c_1 + 2 - \frac{3 \det Q_1 + c_2}{q_{12}^{(1)}} + 3 \left[\frac{q_{22}^{(1)}}{q_{12}^{(1)}} \right]^2 \right\} \quad (1=1,2) \tag{2.6}$$

and

$$q_{ij}^{(1)} = r^{-1} p_{ij}^{(1)}$$

$$\begin{aligned} \det Q_1 &= r^{-1} \cdot \det P_1 = r^{-1} \cdot [p_{11}^{(1)} \cdot p_{22}^{(1)} - p_{12}^{(1)} \cdot p_{21}^{(1)}] \\ &= \frac{1}{2} [1 + (-1)^1 \cdot c + 3 e \cos v] \end{aligned} \quad (2.7)$$

3. STABILITY ANALYSIS

A lot of work has been done on the stability of Hill equations. Here we will use some theorems which give analytical conditions for the stability of the general Hill equation

$$\xi'' + J(v) \cdot \xi = 0 \quad (3.1)$$

where $J(v)$ is a 2π -periodic function.

a. Theorem I (Lyapunov)

If

$$J(v) \geq 0 \quad (3.2)$$

and

$$\int_0^{2\pi} J(v) \cdot dv \leq \frac{2}{\pi} \quad (3.3)$$

then all solutions of (3.1) are stable.

b. Theorem II (Krein)

All solutions of (3.1) are stable if there exists a positive integer n for which

$$J(v) \geq \frac{n^2}{4} \quad (3.4)$$

and

$$\int_0^{2\pi} J(v) \cdot dv < \frac{n^2 \pi}{2} + n(n+1) \operatorname{tg} \frac{\pi}{2(n+1)} \quad (3.5)$$

Both theorems involve the integral

$$Z = \int_0^{2\pi} J(v) \cdot dv$$

For the equations (2.5a) and (2.5b) one obtains after some calculations

$$\begin{aligned}
 Z = \int_0^{2\pi} J_1(v) \cdot dv &= \frac{\pi}{2} \cdot \left\{ 4 - 4 c_1 (1 - e^2)^{-1/2} \right. \\
 &+ 3 \left\{ [2 + (-1)^1 k c] \cdot A_1^{-1} - 3 \right\} \cdot [(A_1 - 1)^2 - k^2 e^2]^{-1/2} \\
 &\left. + 3 \left\{ [2 + (-1)^1 k c] \cdot A_1^{-1} + 3 \right\} \cdot [(A_1 + 1)^2 - k^2 e^2]^{-1/2} \right\} \quad (3.6)
 \end{aligned}$$

with

$$A_1 = [1 + 2 k q_{12}^{(1)}(\frac{\pi}{2})]^{1/2} \quad (l=1,2)$$

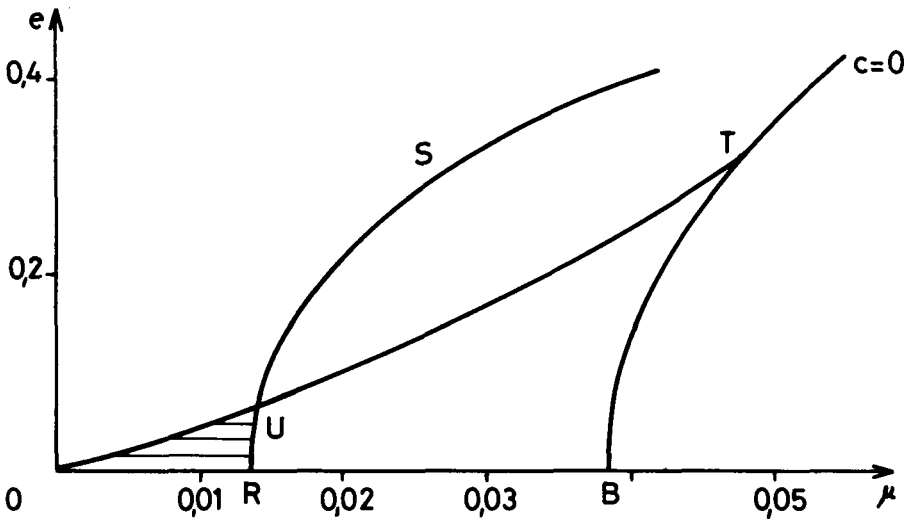

Figure 1. Stable region from Lyapunov's theorem (2.5a)

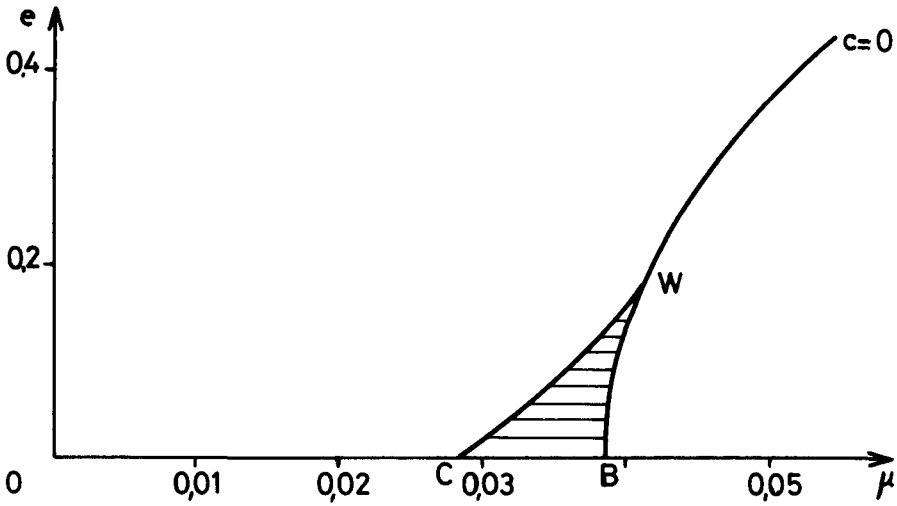

Figure 2. Stable region from Krein's theorem ($n=1$) for (2.5a)

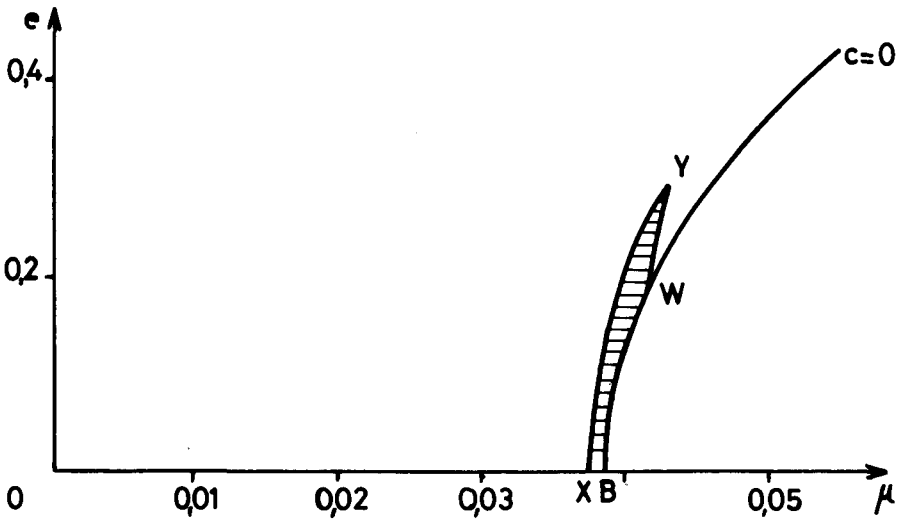

Figure 3. Stable region from Krein's theorem ($n=1$) for (2.5b)

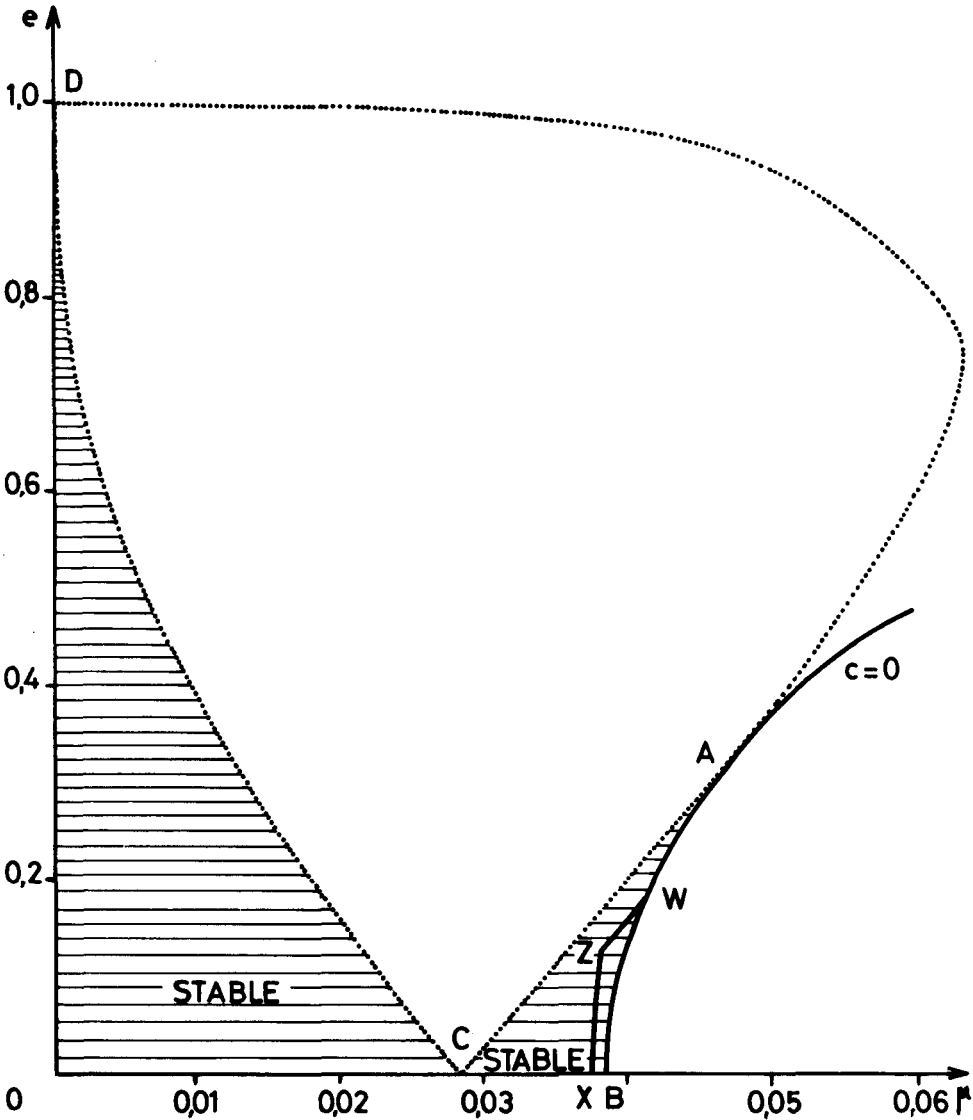

Figure 4. Combined stability region from Krein's theorem

So the conditions for these theorems can be checked analytically for both equations (2.5a) and (2.5b).

Figure 1 shows the results of theorem I, obtained from (2.5a). So we may conclude that all solutions of (2.5a) are stable in the ORU-region of the μ - e plane.

However no results were found for equation (2.5b) using theorem I. So no general conclusion can be made on the complete motion. Yet we should remark that theorem I (and also theorem II) only states sufficient stability conditions.

More interesting results are obtained from theorem II.

Fig. 2 shows a stable region CBW obtained from (2.5a) and fig. 3 shows a stable region XYWB obtained from (2.5b). (For both cases the integer value $n = 1$).

A very interesting point is that there is a common region XZWB of fig. 2 and fig. 3 which is shown in fig. 4.

So we may conclude :

"The triangular points in the elliptic problem are stable for all μ -e values which belong to the XZWB-region of the parameterplane."

For the first time, a stable region is found on a purely analytical basis. Indeed, all previous results were accomplished by numerical integration procedures or analytical approximations for the transition curves. Note however that these results cover only a small part of the numerical results (shaded regions in fig. 4).

4. PERIODIC MOTIONS

Along the transition curves CD, CA and AD of fig. 4 one of the eigenvalues is -1 (see Meire 1981). This means that there exists 4π -periodic solutions along these curves.

We were interested how those 4π -periodic solutions look like.

The curves CD and CA were obtained from the equation (2.3a) and the curve AD from (2.3b) and the curve BA represents $c = 0$.

From equations (2.4) it is clear that (2.3a) and (2.3b) are very similar so we will only consider the explicit form of the equations (2.3a)

$$\begin{cases} y_1' = p_{11} y_1 + p_{12} y_2 & (4.1a) \\ y_2' = p_{21} y_1 + p_{22} y_2 & (4.1b) \end{cases}$$

where the upper indices ⁽¹⁾ for the p_{ij} have been omitted. Now taking

$$\begin{cases} y_1 = \exp\left[\int p_{11} dv\right] \cdot u_1 = r^{\frac{k-1}{2}} \cdot \exp\left(\frac{k}{2r}\right) \cdot u_1 & (4.2a) \\ y_2 = \exp\left[\int p_{22} dv\right] \cdot u_2 = r^{\frac{-(k+1)}{2}} \cdot \exp\left(\frac{-k}{2r}\right) \cdot u_2 & (4.2b) \end{cases}$$

the equations (4.1) are transformed into

$$\begin{cases} u_1' = m_{12} u_2 & (4.3a) \\ u_2' = m_{21} u_1 & (4.3b) \end{cases}$$

where

$$m_{12} = p_{12} r^{-k} \exp\left(-\frac{k}{r}\right) \quad (4.4a)$$

$$m_{21} = p_{21} r^k \exp\left(\frac{k}{r}\right) \quad (4.4b)$$

From the equations (4.2) it follows that if y_1 becomes zero then so does u_1 and vice versa (the same holds for y_2 and u_2). Equations (4.3) show that every crossing of the axes in the u_1 - u_2 plane is perpendicular to these axes.

It can be shown (see Meire 1980) that $p_{12}(v)$ and thus $m_{12}(v) \geq 0$ for $0 \leq e \leq 1, 0 \leq \mu \leq 1/3$.

Also it is easy to prove that $p_{21}(0)$ or $m_{21}(0) < 0$ for all possible μ - and e -values.

For certain regions in the μ - e plane p_{21} and consequently m_{21} will remain negative for all values of v whereas for other regions, they can become positive. In the former case the extremum values of u_1 and u_2 can only be reached when crossing the u_1 - or u_2 -axis, while in the latter case u_2 will reach additional extremum values (where $u_1 \neq 0$ but $m_{21} = 0$).

Fig. 5a, fig. 6a and fig. 7a show three possible types of 4π -periodic orbits in the u_1 - u_2 plane and fig. 5b, fig. 6b and fig. 7b show the corresponding orbits in the y_1 - y_2 plane.

In the case of fig. 5a the coefficient $m_{21}(v)$ remains negative for every value of the true anomaly, while for fig. 6a and fig. 7a $m_{21}(v)$ also becomes positive, so that u_2 reaches additional extremum values.

Further research on the shape of these curves has been done and will be published in another paper.

This however is a first attempt to explain the shape of periodic orbits around the triangular points in the elliptic restricted problem and it has become clear that the work of Tschauer is very important for the further study of this interesting problem.

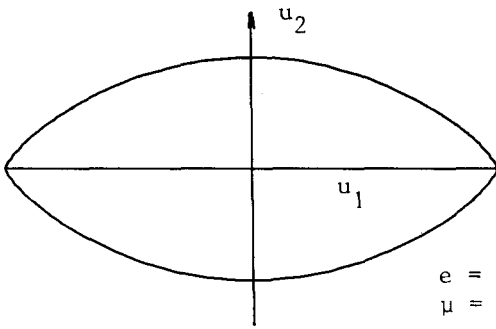

Fig. 5a

$$e = 0.3$$

$$\mu = 0.046155$$

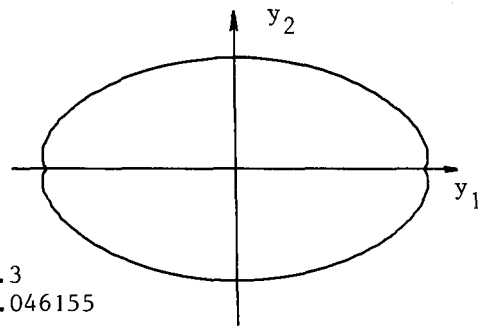

Fig. 5b

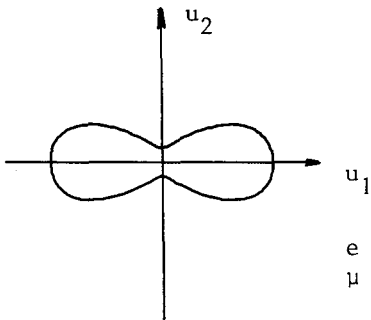

Fig. 6a

$$e = 0.6$$

$$\mu = 0.003781$$

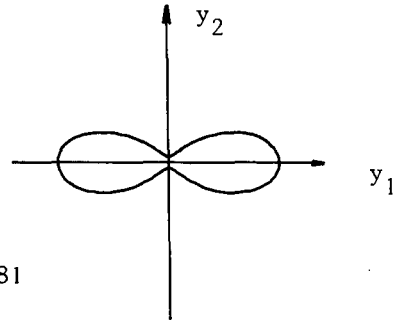

Fig. 6b

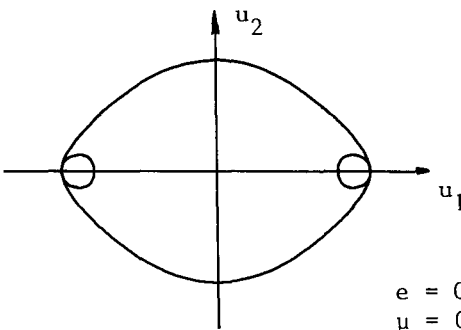

Fig. 7a

$$e = 0.8$$

$$\mu = 0.062314$$

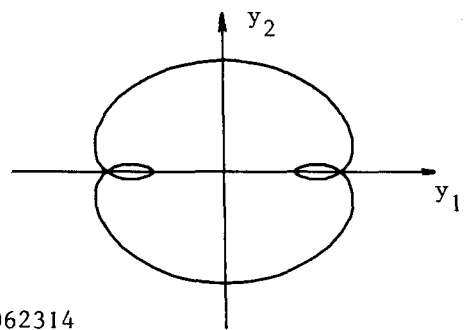

Fig. 7b

5. REFERENCES

- Bennett A. (1965), Icarus 4, p 177
- Danby J.M.A. (1964), Astron. J. 69, p 165
- Hale J.K. (1969), "Ordinary Differential Equations", Wiley, New York
- Krein M.G. (1955), Prikl. Mat. Mech. 15 (1951), English translation in Am. Math. Soc. Trans. Series 2, 1, p 163
- Matas V. (1973) Bull. Astron. Inst. Czech. 24, p 249
- Meire R. (1980), Bull. Astron. Inst. Czech. 31, p 312
- Meire R. (1981), Cel. Mech. 23, p 89
- Meire R. (1982), Astron. Astroph. 110, p 152
- Szebehely V. (1967), "Theory of Orbits", Academic Press, New York
- Tschauner J. (1971), Cel. Mech. 3, p 189