

COMPOSITIO MATHEMATICA

Bases for cluster algebras from surfaces

Gregg Musiker, Ralf Schiffler and Lauren Williams

Compositio Math. **149** (2013), 217–263.

[doi:10.1112/S0010437X12000450](https://doi.org/10.1112/S0010437X12000450)



FOUNDATION
COMPOSITIO
MATHEMATICA



LONDON
MATHEMATICAL
SOCIETY



Bases for cluster algebras from surfaces

Gregg Musiker, Ralf Schiffler and Lauren Williams

ABSTRACT

We construct two bases for each cluster algebra coming from a triangulated surface without punctures. We work in the context of a coefficient system coming from a full-rank exchange matrix, such as *principal coefficients*.

Contents

1	Introduction	218
2	Preliminaries and notation	221
2.1	Cluster algebras	221
2.2	Cluster algebras with principal coefficients	223
2.3	Cluster algebras arising from surfaces	224
2.4	Skein relations	227
2.5	Chebyshev polynomials	228
3	Definition of the two bases \mathcal{B}° and \mathcal{B}	230
3.1	Snake graphs and band graphs	230
3.2	Laurent polynomials associated to generalized arcs and closed loops	233
3.3	Bangles and bracelets	235
4	Proof of the main result	236
4.1	\mathcal{B}° and \mathcal{B} are subsets of \mathcal{A}	236
4.2	\mathcal{B}° and \mathcal{B} are spanning sets for \mathcal{A}	240
4.3	\mathcal{B}° and \mathcal{B} are linearly independent sets	241
5	Lattice structure of the matchings of snake and band graphs	241
6	The g-vector map and linear independence of \mathcal{B}° and \mathcal{B}	245
6.1	Fans	247
6.2	Multicurves and leading terms	248
6.3	An inverse for the g-vector map	249
7	Coefficient systems coming from a full-rank exchange matrix	251
	Acknowledgements	253
	Appendix A Extending the results to surfaces with punctures	253
A.1	Definition of \mathcal{B}° and \mathcal{B}	253
A.2	Cluster algebra elements associated to generalized tagged arcs	254
A.3	Cluster algebra elements associated to closed loops	255
A.4	\mathcal{B}° and \mathcal{B} are spanning sets for \mathcal{A}	255

Received 19 October 2011, accepted in final form 8 May 2012, published online 7 December 2012.

2010 Mathematics Subject Classification. 13F60 (primary), 05C70, 05E15 (secondary).

Keywords: cluster algebra, basis, triangulated surfaces.

The first author was partially supported by the NSF grant DMS-1067183. The second author was partially supported by the NSF grant DMS-1001637. The third author was partially supported by the NSF grant DMS-0854432 and an NSF CAREER award.

This journal is © Foundation Compositio Mathematica 2012.

A.5 \mathcal{B}° and \mathcal{B} are linearly independent sets	259
A.6 \mathcal{B}° and \mathcal{B} are subsets of \mathcal{A}	260
References	260

1. Introduction

Fomin and Zelevinsky introduced cluster algebras in [FZ02], in an attempt to create an algebraic framework for Lusztig’s dual canonical bases and total positivity in semisimple groups [Lus90, Lus93, Lus94]. In particular, writing down explicitly the elements of the dual canonical basis is a very difficult problem; but Fomin and Zelevinsky conjectured that a large subset of these elements can be understood via the machinery of cluster algebras. More precisely, they conjectured that all monomials in the variables of any given cluster (the *cluster monomials*) belong to (the classical limit as $q \rightarrow 1$ of) the dual canonical basis [FZ02]. For recent progress in this direction, see [GLS11b, HL11, Lam11a, Lam11b].

Because of the conjectural connection between cluster algebras and dual canonical bases, it is natural to ask whether one can construct a ‘good’ (vector space) basis \mathcal{B} for each cluster algebra \mathcal{A} . In keeping with Fomin and Zelevinsky’s conjecture, such a basis should include the cluster monomials. Additionally, since the dual canonical basis has striking positivity properties, a good basis of a cluster algebra should also have analogous positivity properties. In particular, if we define \mathcal{A}^+ to be the set of elements of \mathcal{A} which expand positively with respect to every cluster, then one should require that every element $b \in \mathcal{B}$ also belong to \mathcal{A}^+ . In the case where b is a cluster variable, this requirement is equivalent to the well-known *positivity conjecture*, one of the main open questions about cluster algebras.

The construction of bases for cluster algebras is a problem that has attracted a lot of attention recently. Caldero and Keller showed that for cluster algebras of finite type, the cluster monomials form a basis [CK08]. For cluster algebras which are not of finite type, the cluster monomials do not span the cluster algebra, but it follows from [CKLP12] (see also [DWZ10, Pla11b]) that they are linearly independent. Sherman and Zelevinsky constructed bases containing the cluster monomials for the cluster algebra of rank 2 affine types [SZ04, Zel07], and Cerulli-Irelli did so for rank 3 affine types [Cer09]. Dupont has used cluster categories to construct the so-called *generic basis* for the affine types [Dup08, Dup11]; see also [DXX09]. Geiss, Leclerc and Schröer constructed the generic basis in a much more general setting [GLS11a, GLS12], which includes, in particular, all acyclic cluster algebras. Plamondon [Pla11a, ch. 5] gives a convenient reparameterization of the Geiss–Leclerc–Schröer basis.

There is an important class of cluster algebras associated to *surfaces with marked points* [FG06, FG09, FST08, FT08, GSV05]. Such cluster algebras are of interest for several reasons. First, they have a topological interpretation: they may be viewed as coordinate rings of the corresponding *decorated Teichmüller space* [Pen87, Pen06]. Second, such cluster algebras constitute most of the *mutation-finite* cluster algebras [FST12], that is, the cluster algebras which have finitely many different exchange matrices. The (generalized) cluster category of a cluster algebra from a surface has been defined whenever the surface has a non-empty boundary [Ami09, ABCP10, BMRRT06, CL12, Lab09]. It has been described in geometric terms in [CCS06] for the disk, in [Sch08] for the disk with one puncture, and in [BZ10] for arbitrary surfaces without punctures.

Note that the aforementioned constructions do not yield bases in the case of cluster algebras from surfaces, in general.

The present paper was inspired by work of Fock and Goncharov [FG06] and Fomin, Shapiro and Thurston [Thu08]. In [FG06], Fock and Goncharov introduced a canonical basis for the cluster varieties related to SL_2 . In particular, their construction gives a basis for the algebra of universally Laurent polynomials in the dual space, which coincides with the (coefficient-free) *upper* cluster algebra associated to the surface. (Note that, in general, the upper cluster algebra contains but is not equal to the cluster algebra.) Moreover, the elements of their bases have positive Laurent expansions in all of the clusters that they consider [FG06]. In a lecture series in 2008 [Thu08], Thurston announced a construction of two bases associated to a cluster algebra from a surface, based on joint work with Fomin and Shapiro, and inspired by [FG06]; note, however, that this work was not completed.

Both of these constructions are parameterized by the same collections \mathcal{C}° and \mathcal{C} of curves in a surface. Recall that an *arc* in a surface with marked points is (the isotopy class of) a curve connecting two marked points which has no self-crossings. A *closed loop* is a non-contractible closed curve which is disjoint from the boundary. A closed loop without self-crossings is said to be *essential*. A multiset of k copies of the same essential loop is called a *k-bangle*, and a closed loop obtained by following an essential loop k times, thus creating $k - 1$ self-crossings, is called a *k-bracelet*. Let \mathcal{C}° be the collection of multisets of arcs and essential loops which have no crossings, and let \mathcal{C} be obtained from \mathcal{C}° by replacing the maximal k -bangles by the corresponding k -bracelets. In [FG06], the authors associated a Laurent polynomial to each collection of curves by using (the upper right entry or trace of) an appropriate product of elements of SL_2 . In [Thu08], the authors associated a cluster algebra element to a collection of curves by using the (normalized) lambda length of that collection. These two notions coincide.

In our previous work [MSW11], we gave combinatorial formulas for the cluster variables in the cluster algebra associated to any surface with marked points, building on earlier work in [MS10, Sch08, ST09, Sch10]. The formula for the cluster variable associated to an arc is a weighted sum over perfect matchings of a planar *snake graph* associated to the arc. (There are similar formulas for other cluster variables.) Since these formulas are manifestly positive, the positivity conjecture follows as a corollary.

In the present paper, we generalize our formulas from [MSW11] to associate a Laurent polynomial to each collection of curves in \mathcal{C}° and \mathcal{C} in an unpunctured surface (S, M) (i.e. all marked points lie on the boundary). Instead of using perfect matchings of a planar graph, the Laurent polynomial associated to a closed curve is a weighted sum over *good* matchings in a *band graph* on a Möbius strip or annulus. We work in the context of a cluster algebra \mathcal{A} associated to (S, M) whose coefficient system comes from a full-rank exchange matrix: for example, principal coefficients. In this way we construct bases \mathcal{B}° and \mathcal{B} for \mathcal{A} which are parameterized by the collections \mathcal{C}° and \mathcal{C} . Our bases are manifestly positive, in the sense that both \mathcal{B}° and \mathcal{B} are contained in \mathcal{A}^+ . For surfaces with punctures, we still have a construction of sets \mathcal{B}° and \mathcal{B} , but not all of the proofs can be adapted to that case.

While not obvious, it is possible to show via the results of [MW11] that the bases we consider in this paper coincide with those considered in [Thu08], as well as (in the coefficient-free case) with those in [FG06].

Our main result is the following theorem.

THEOREM 1.1. *Let \mathcal{A} be a cluster algebra with principal coefficients from an unpunctured surface which has at least two marked points. Then \mathcal{B}° and \mathcal{B} are both bases of \mathcal{A} . Moreover, each element of \mathcal{B}° and \mathcal{B} has a positive Laurent expansion with respect to any cluster of \mathcal{A} .*

COROLLARY 1.2. *Let \mathcal{A}_* be a cluster algebra from an unpunctured surface with at least two marked points, whose coefficient system comes from a full-rank exchange matrix. Then there are bases \mathbb{B}° and \mathbb{B} for \mathcal{A}_* whose elements have positive Laurent expansions with respect to every cluster of \mathcal{A}_* .*

We are grateful to Goncharov (personal communication, October 2011) for pointing out that by using the results in [FG06] together with Theorem 1.1, one may deduce Corollary 1.3(a).

COROLLARY 1.3. *Let \mathcal{A} be a coefficient-free cluster algebra from an unpunctured surface with at least two marked points.*

- (a) *The upper cluster algebra coincides with the cluster algebra.*
- (b) *\mathcal{B}° and \mathcal{B} are both bases of \mathcal{A} .*

Besides the property that \mathcal{B}° and \mathcal{B} lie in \mathcal{A}^+ , one might ask whether the structure constants for these bases are positive. In other words, is it the case that every product of basis elements, when expanded as a linear combination of basis elements, has all coefficients positive?

CONJECTURE 1.4 ([FG06, §12] and [Thu08]). Both bases \mathcal{B}° and \mathcal{B} have positive structure constants.

As a partial result in this direction, Cerulli-Irelli and Labardini [CL12] showed that for a surface with non-empty boundary, the elements of \mathcal{A}^+ that lie in the span of the set of cluster monomials have positive structure constants.

Finally, one might ask whether either of these bases is *atomic*. We say that \mathcal{B} is an atomic basis for \mathcal{A} if $a \in \mathcal{A}^+$ if and only if when we write $a = \sum_{b \in \mathcal{B}} \lambda_b b$, every coefficient λ_b is non-negative. Sherman and Zelevinsky showed that the bases they constructed are atomic. They also showed that if an atomic basis exists, it is necessarily unique [SZ04].

In the case of finite-type cluster algebras, Cerulli-Irelli [Cer11] showed that the basis of cluster monomials is in fact atomic. Recently, Dupont and Thomas proved in [DT11] that the basis constructed by Dupont in [Dup10] for the affine $\tilde{\mathbb{A}}$ types is an atomic basis. That basis coincides with our basis \mathcal{B} in the case where the surface is an annulus and all coefficients are set to 1. Their proof uses the surface model, and we expect that it can be generalized to arbitrary unpunctured surfaces.

CONJECTURE 1.5. The basis \mathcal{B} is an atomic basis.

To prove Theorem 1.1 we need to show that \mathcal{B}° and \mathcal{B} are contained in \mathcal{A} , that they form a spanning set, and that they are linearly independent. The positivity property follows by construction (elements are defined as sums over perfect matchings of certain graphs) together with [FZ07, Theorem 3.7]. We show that both \mathcal{B}° and \mathcal{B} are spanning sets by using skein relations with principal coefficients [MW11]. In order to show linear independence, we need to extend the notion of \mathbf{g} -vector, defined in [FZ07], to \mathcal{B}° and \mathcal{B} . Along the way, we prove that the set of monomials in the Laurent expansions of elements of \mathcal{B}° and \mathcal{B} have the structure of a distributive lattice. The following result, which may be interesting in its own right, then implies linear independence of both \mathcal{B}° and \mathcal{B} .

THEOREM 1.6. *Let \mathcal{A} be a cluster algebra with principal coefficients from an unpunctured surface which has at least two marked points. Then the \mathbf{g} -vector induces bijections $\mathcal{B}^\circ \rightarrow \mathbb{Z}^n$ and $\mathcal{B} \rightarrow \mathbb{Z}^n$.*

The paper is organized as follows. After recalling some background on cluster algebras in § 2, we define the bases \mathcal{B}° and \mathcal{B} in § 3. Sections 4–6 are devoted to the proof of our main result, in the context of principal coefficients. Corollary 1.3 is proven at the end of § 4.2. In § 7, we explain how to construct bases for cluster algebras from surfaces in which the coefficient system comes from a full-rank exchange matrix. Finally, in Appendix A, we briefly sketch how to extend our result to surfaces with punctures, and explain which part of the proof does not generalize easily.

2. Preliminaries and notation

In this section, we review some notions from the theory of cluster algebras.

2.1 Cluster algebras

We begin by reviewing the definition of a cluster algebra, first introduced by Fomin and Zelevinsky in [FZ02]. Our definition follows the exposition in [FZ07]. Another good reference for cluster algebras is [GSV10].

To define a cluster algebra \mathcal{A} , we must first fix its ground ring. Let $(\mathbb{P}, \oplus, \cdot)$ be a *semifield*, i.e. an abelian multiplicative group endowed with a binary operation of (*auxiliary*) *addition*, \oplus , which is commutative, associative and distributive with respect to the multiplication in \mathbb{P} . The group ring $\mathbb{Z}\mathbb{P}$ will be used as a *ground ring* for \mathcal{A} . One important choice for \mathbb{P} is the tropical semifield; in this case, we say that the corresponding cluster algebra is of *geometric type*. Let $\text{Trop}(u_1, \dots, u_m)$ be an abelian group (written multiplicatively) freely generated by the u_j . We define \oplus in $\text{Trop}(u_1, \dots, u_m)$ by

$$\prod_j u_j^{a_j} \oplus \prod_j u_j^{b_j} = \prod_j u_j^{\min(a_j, b_j)} \tag{2.1}$$

and call $(\text{Trop}(u_1, \dots, u_m), \oplus, \cdot)$ a *tropical semifield*. Note that the group ring of $\text{Trop}(u_1, \dots, u_m)$ is the ring of Laurent polynomials in the variables u_j .

As an *ambient field* for \mathcal{A} , we take a field \mathcal{F} isomorphic to the field of rational functions in n independent variables (here n is the *rank* of \mathcal{A}) with coefficients in $\mathbb{Q}\mathbb{P}$. Note that the definition of \mathcal{F} does not involve the auxiliary addition in \mathbb{P} .

DEFINITION 2.1. A *labeled seed* in \mathcal{F} is a triple $(\mathbf{x}, \mathbf{y}, B)$ where:

- $\mathbf{x} = (x_1, \dots, x_n)$ is an n -tuple from \mathcal{F} forming a *free generating set* over $\mathbb{Q}\mathbb{P}$;
- $\mathbf{y} = (y_1, \dots, y_n)$ is an n -tuple from \mathbb{P} ;
- $B = (b_{ij})$ is an $n \times n$ integer matrix which is *skew-symmetrizable*.

That is, x_1, \dots, x_n are algebraically independent over $\mathbb{Q}\mathbb{P}$, and $\mathcal{F} = \mathbb{Q}\mathbb{P}(x_1, \dots, x_n)$. We refer to \mathbf{x} as the (labeled) *cluster* of a labeled seed $(\mathbf{x}, \mathbf{y}, B)$, to the tuple \mathbf{y} as the *coefficient tuple*, and to the matrix B as the *exchange matrix*.

We obtain (*unlabeled*) *seeds* from labeled seeds by identifying labeled seeds that differ from each other via simultaneous permutations of the components in \mathbf{x} and \mathbf{y} and of the rows and columns of B .

We use the notation $[x]_+ = \max(x, 0)$, $[1, n] = \{1, \dots, n\}$, and

$$\text{sgn}(x) = \begin{cases} -1 & \text{if } x < 0, \\ 0 & \text{if } x = 0, \\ 1 & \text{if } x > 0. \end{cases}$$

DEFINITION 2.2. Let $(\mathbf{x}, \mathbf{y}, B)$ be a labeled seed in \mathcal{F} , and let $k \in [1, n]$. The *seed mutation* μ_k in direction k transforms $(\mathbf{x}, \mathbf{y}, B)$ into the labeled seed $\mu_k(\mathbf{x}, \mathbf{y}, B) = (\mathbf{x}', \mathbf{y}', B')$ defined as follows.

- The entries of $B' = (b'_{ij})$ are given by

$$b'_{ij} = \begin{cases} -b_{ij} & \text{if } i = k \text{ or } j = k, \\ b_{ij} + \text{sgn}(b_{ik})[b_{ik}b_{kj}]_+ & \text{otherwise.} \end{cases} \tag{2.2}$$

- The coefficient tuple $\mathbf{y}' = (y'_1, \dots, y'_n)$ is given by

$$y'_j = \begin{cases} y_k^{-1} & \text{if } j = k, \\ y_j y_k^{[b_{kj}]_+} (y_k \oplus 1)^{-b_{kj}} & \text{if } j \neq k. \end{cases} \tag{2.3}$$

- The cluster $\mathbf{x}' = (x'_1, \dots, x'_n)$ is given by $x'_j = x_j$ for $j \neq k$, whereas $x'_k \in \mathcal{F}$ is determined by the *exchange relation*

$$x'_k = \frac{y_k \prod x_i^{[b_{ik}]_+} + \prod x_i^{[-b_{ik}]_+}}{(y_k \oplus 1)x_k}. \tag{2.4}$$

We say that two exchange matrices B and B' are *mutation-equivalent* if one can get from B to B' by a sequence of mutations.

DEFINITION 2.3. Consider the n -regular tree \mathbb{T}_n whose edges are labeled by the numbers $1, \dots, n$, so that the n edges emanating from each vertex receive different labels. A *cluster pattern* is an assignment of a labeled seed $\Sigma_t = (\mathbf{x}_t, \mathbf{y}_t, B_t)$ to every vertex $t \in \mathbb{T}_n$ such that the seeds assigned to the endpoints of any edge $t \overset{k}{-} t'$ are obtained from each other by the seed mutation in direction k . The components of Σ_t are written as

$$\mathbf{x}_t = (x_{1;t}, \dots, x_{n;t}), \quad \mathbf{y}_t = (y_{1;t}, \dots, y_{n;t}), \quad B_t = (b'_{ij}). \tag{2.5}$$

Clearly, a cluster pattern is uniquely determined by an arbitrary seed.

DEFINITION 2.4. Given a cluster pattern, we let

$$\mathcal{X} = \bigcup_{t \in \mathbb{T}_n} \mathbf{x}_t = \{x_{i,t} \mid t \in \mathbb{T}_n, 1 \leq i \leq n\}, \tag{2.6}$$

the union of clusters of all the seeds in the pattern. The elements $x_{i,t} \in \mathcal{X}$ are called *cluster variables*. The *cluster algebra* \mathcal{A} associated with a given pattern is the \mathbb{ZP} -subalgebra of the ambient field \mathcal{F} generated by all cluster variables: $\mathcal{A} = \mathbb{ZP}[\mathcal{X}]$. We write $\mathcal{A} = \mathcal{A}(\mathbf{x}, \mathbf{y}, B)$, where $(\mathbf{x}, \mathbf{y}, B)$ is any seed in the underlying cluster pattern.

The remarkable *Laurent phenomenon* asserts the following.

THEOREM 2.5 [FZ02, Theorem 3.1]. *The cluster algebra \mathcal{A} associated with a seed $(\mathbf{x}, \mathbf{y}, B)$ is contained in the Laurent polynomial ring $\mathbb{ZP}[\mathbf{x}^{\pm 1}]$; that is, every element of \mathcal{A} is a Laurent polynomial over \mathbb{ZP} in the cluster variables from $\mathbf{x} = (x_1, \dots, x_n)$.*

Remark 2.6. In cluster algebras with ground ring $\text{Trop}(u_1, \dots, u_m)$ (the tropical semifield), it is convenient to replace the matrix B by an $(n + m) \times n$ matrix $\tilde{B} = (b_{ij})$ whose upper part is the $n \times n$ matrix B and whose lower part is an $m \times n$ matrix that encodes the coefficient tuple via

$$y_k = \prod_{i=1}^m u_i^{b_{(n+i)k}}. \tag{2.7}$$

Then the mutation of the coefficient tuple in (2.3) is determined by the mutation of the matrix \tilde{B} in (2.2) and the formula (2.7), and the exchange relation (2.4) becomes

$$x'_k = x_k^{-1} \left(\prod_{i=1}^n x_i^{[b_{ik}]_+} \prod_{i=1}^m u_i^{[b_{(n+i)k}]_+} + \prod_{i=1}^n x_i^{[-b_{ik}]_+} \prod_{i=1}^m u_i^{[-b_{(n+i)k}]_+} \right). \tag{2.8}$$

2.2 Cluster algebras with principal coefficients

Fomin and Zelevinsky introduced in [FZ07] a special type of coefficients, called *principal coefficients*.

DEFINITION 2.7. We say that a cluster pattern $t \mapsto (\mathbf{x}_t, \mathbf{y}_t, B_t)$ on \mathbb{T}_n (or the corresponding cluster algebra \mathcal{A}) has *principal coefficients at a vertex t_0* if $\mathbb{P} = \text{Trop}(y_1, \dots, y_n)$ and $\mathbf{y}_{t_0} = (y_1, \dots, y_n)$. In this case, we write $\mathcal{A} = \mathcal{A}_\bullet(B_{t_0})$.

Remark 2.8. Definition 2.7 can be rephrased as follows: a cluster algebra \mathcal{A} has principal coefficients at a vertex t_0 if \mathcal{A} is of geometric type and is associated with the matrix \tilde{B}_{t_0} of order $2n \times n$ whose upper part is B_{t_0} and whose complementary (i.e. bottom) part is the $n \times n$ identity matrix (cf. [FZ02, Corollary 5.9]).

DEFINITION 2.9. Let \mathcal{A} be the cluster algebra with principal coefficients at t_0 , defined by the initial seed $\Sigma_{t_0} = (\mathbf{x}_{t_0}, \mathbf{y}_{t_0}, B_{t_0})$ with

$$\mathbf{x}_{t_0} = (x_1, \dots, x_n), \quad \mathbf{y}_{t_0} = (y_1, \dots, y_n), \quad B_{t_0} = B^0 = (b_{ij}^0). \tag{2.9}$$

By the Laurent phenomenon, we can express every cluster variable $x_{\ell;t}$ as a (unique) Laurent polynomial in $x_1, \dots, x_n, y_1, \dots, y_n$; we denote this by

$$X_{\ell;t} = X_{\ell;t}^{B^0; t_0}. \tag{2.10}$$

Let $F_{\ell;t} = F_{\ell;t}^{B^0; t_0}$ denote the Laurent polynomial obtained from $X_{\ell;t}$ by

$$F_{\ell;t}(y_1, \dots, y_n) = X_{\ell;t}(1, \dots, 1; y_1, \dots, y_n); \tag{2.11}$$

then $F_{\ell;t}(y_1, \dots, y_n)$ turns out to be a polynomial [FZ07] and is called an *F-polynomial*.

PROPOSITION 2.10 [FZ07, Corollary 6.2]. *Consider any rank n cluster algebra defined by an $n \times n$ exchange matrix B , and consider the \mathbf{g} -vector grading given by $\deg(x_i) = \mathbf{e}_i$ and $\deg(y_j) = -\mathbf{b}_j$, where $\mathbf{e}_i = (0, \dots, 0, 1, 0, \dots, 0) \in \mathbb{Z}^n$ with 1 at position i and $\mathbf{b}_j = \sum_i b_{ij} \mathbf{e}_i$ is the j th column of B . Then the Laurent expansion of any cluster variable with respect to the seed $(\mathbf{x}, \mathbf{y}, B)$ is homogeneous with respect to this grading.*

DEFINITION 2.11. The \mathbf{g} -vector $\mathbf{g}(x_\gamma)$ of a cluster variable x_γ , with respect to the seed $(\mathbf{x}, \mathbf{y}, B)$, is the multidegree of the Laurent expansion of x_γ with respect to $(\mathbf{x}, \mathbf{y}, B)$, using the \mathbf{g} -vector grading of Proposition 2.10.

Remark 2.12. It follows from Proposition 2.10 that the monomial in the x_i 's and y_j 's whose exponent vector is the column $\tilde{\mathbf{b}}_j$ of the extended $2n \times n$ matrix \tilde{B} has degree 0.

PROPOSITION 2.13. Let \tilde{B} be an $m \times n$ extended exchange matrix with linearly independent columns, and let $\mathcal{A} = \mathcal{A}(\tilde{B})$ be the associated cluster algebra, with initial seed $(\{x_1, \dots, x_n\}, \tilde{B})$ and coefficient variables x_{n+1}, \dots, x_m . Let U be a set of elements in $\mathcal{A}(\tilde{B})$ whose Laurent expansions with respect to the initial seed all have the form

$$\mathbf{x}^g + \sum_h \lambda_h \mathbf{x}^{g+h},$$

where \mathbf{x}^a denotes $x_1^{a_1} \dots x_m^{a_m}$, λ_h is a scalar, and each h is a non-negative linear combination of columns of \tilde{B} . Suppose, moreover, that the vectors g and g' associated to two different elements of U differ in at least one of the first n coordinates. Then the elements of U are linearly independent over the ground ring of \mathcal{A} .

The proof below comes from the arguments of [FZ07, Remark 7.11].

Proof. Because the columns of \tilde{B} are linearly independent, we can define a partial order on \mathbb{Z}^m by $u \leq v$ if and only if v can be obtained from u by adding a non-negative linear combination of columns of \tilde{B} . Applying this partial order to Laurent monomials in $\{x_1, \dots, x_m\}$, it follows that each element $\mathbf{x}^g + \sum_h \lambda_h \mathbf{x}^{g+h}$ of U has leading term \mathbf{x}^g . Moreover, all leading terms have pairwise distinct exponent vectors, and even if we multiply each element of U by an arbitrary monomial in the coefficient variables x_{n+1}, \dots, x_m , the leading terms will still have pairwise distinct exponent vectors. Therefore any linear combination of elements of U which sums to 0 must necessarily have all coefficients equal to 0. \square

2.3 Cluster algebras arising from surfaces

We follow the work of Fock and Goncharov [FG06, FG09], Gekhtman, Shapiro and Vainshtein [GSV05] and Fomin, Shapiro and Thurston [FST08], who associated a cluster algebra to any bordered surface with marked points. In this subsection we will recall that construction in the special case of surfaces without punctures.

DEFINITION 2.14. Let S be a connected oriented 2-dimensional Riemann surface with non-empty boundary, and let M be a non-empty finite subset of the boundary of S such that each boundary component of S contains at least one point of M . The elements of M are called *marked points*. The pair (S, M) is called a *bordered surface with marked points*.

For technical reasons, we require that (S, M) not be a disk with one, two or three marked points.

DEFINITION 2.15. An arc γ in (S, M) is a curve in S , considered up to isotopy, such that:

- (a) the endpoints of γ are in M ;
- (b) γ does not cross itself, except that its endpoints may coincide;
- (c) except for the endpoints, γ is disjoint from the boundary of S ; and
- (d) γ does not cut out a monogon or a bigon.

Curves that connect two marked points and lie entirely on the boundary of S without passing through a third marked point are *boundary segments*. Note that boundary segments are not arcs.

DEFINITION 2.16 (Crossing numbers and compatibility of ordinary arcs). For any two arcs γ and γ' in S , let $e(\gamma, \gamma')$ be the minimal number of crossings of arcs α and α' , where α and α' range over all arcs isotopic to γ and γ' , respectively. We say that the arcs γ and γ' are *compatible* if $e(\gamma, \gamma') = 0$.

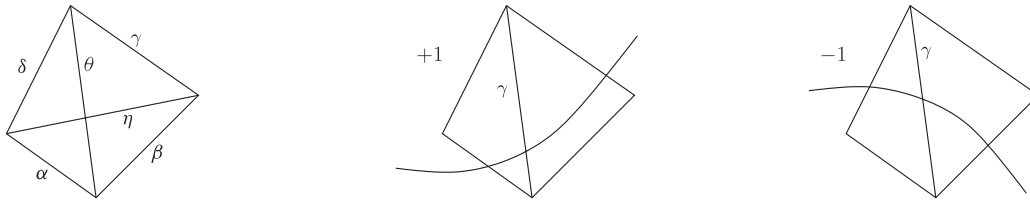

FIGURE 1. Exchange relation and shear coordinates.

DEFINITION 2.17. A *triangulation* is a maximal collection of pairwise compatible arcs (together with all boundary segments).

DEFINITION 2.18. Triangulations are connected to each other by sequences of *flips*. Each flip replaces a single arc γ in a triangulation T by a (unique) arc $\gamma' \neq \gamma$ that, together with the remaining arcs in T , forms a new triangulation.

DEFINITION 2.19. Choose any triangulation T of (S, M) , and let $\tau_1, \tau_2, \dots, \tau_n$ be the n arcs of T . For any triangle Δ in T , we define a matrix $B^\Delta = (b_{ij}^\Delta)_{1 \leq i \leq n, 1 \leq j \leq n}$ as follows:

- $b_{ij}^\Delta = 1$ and $b_{ji}^\Delta = -1$ if τ_i and τ_j are sides of Δ with τ_j following τ_i in the clockwise order;
- $b_{ij}^\Delta = 0$ otherwise.

Then define the matrix $B_T = (b_{ij})_{1 \leq i \leq n, 1 \leq j \leq n}$ by $b_{ij} = \sum_{\Delta} b_{ij}^\Delta$, where the sum is taken over all triangles in T .

Note that B_T is skew-symmetric and each entry b_{ij} is either 0, ± 1 or ± 2 , since every arc τ is in at most two triangles.

THEOREM 2.20 ([FST08, Theorem 7.11] and [FT08, Theorem 5.1]). *Fix a bordered surface (S, M) and let \mathcal{A} be the cluster algebra associated to the signed adjacency matrix of a triangulation. Then the (unlabeled) seeds Σ_T of \mathcal{A} are in bijection with the triangulations T of (S, M) , and the cluster variables are in bijection with the arcs of (S, M) (so we can denote each by x_γ where γ is an arc). Moreover, each seed in \mathcal{A} is uniquely determined by its cluster. Furthermore, if a triangulation T' is obtained from another triangulation T by flipping an arc $\gamma \in T$ and obtaining γ' , then $\Sigma_{T'}$ is obtained from Σ_T by the seed mutation replacing x_γ by $x_{\gamma'}$.*

The exchange relation corresponding to a flip in a triangulation is called a *generalized Ptolemy relation*. It can be described as follows.

PROPOSITION 2.21 [FT08]. *Let α, β, γ and δ be arcs or boundary segments of (S, M) which cut out a quadrilateral; we assume that the sides of the quadrilateral, listed in cyclic order, are $\alpha, \beta, \gamma, \delta$. Let η and θ be the two diagonals of this quadrilateral; see the leftmost diagram in Figure 1. Then*

$$x_\eta x_\theta = Y x_\alpha x_\gamma + Y' x_\beta x_\delta \tag{2.12}$$

for some coefficients Y and Y' .

Proof. This follows from the interpretation of cluster variables as *lambda lengths* and the Ptolemy relations for lambda lengths [FT08, Theorem 7.5 and Proposition 6.5]. □

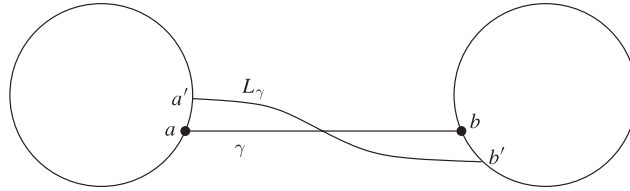

FIGURE 2. Elementary lamination L_γ corresponding to γ .

2.3.1 *Keeping track of coefficients using laminations.* So far we have not addressed the topic of coefficients for cluster algebras arising from bordered surfaces. It turns out that Thurston’s theory of measured laminations [Thu88] gives a concrete way to think about coefficients, as described in [FT08, §§ 11–12] (see also [FG07]).

DEFINITION 2.22. A *lamination* on a bordered surface (S, M) is a finite collection of non-self-intersecting and pairwise non-intersecting curves in S , modulo isotopy relative to M , subject to the following restrictions. Each curve must be one of the following:

- a closed curve;
- a curve connecting two unmarked points on the boundary of S .

Also, we forbid curves with two endpoints on the boundary of S which are isotopic to a piece of boundary containing zero or one marked point.

DEFINITION 2.23. Let L be a lamination, and let T be a triangulation. For each arc $\gamma \in T$, the corresponding *shear coordinate* of L with respect to T , denoted by $b_\gamma(T, L)$, is defined as a sum of contributions from all intersections of curves in L with γ . Specifically, such an intersection contributes $+1$ (respectively, -1) to $b_\gamma(T, L)$ if the corresponding segment of a curve in L cuts through the quadrilateral surrounding γ as shown in the middle (respectively, rightmost) diagram of Figure 1.

DEFINITION 2.24. A *multi-lamination* is a finite family of laminations. For any multi-lamination $\mathbf{L} = (L_{n+1}, \dots, L_{n+m})$ and any triangulation T of (S, M) , define the matrix $\tilde{B} = \tilde{B}_{T, \mathbf{L}} = (b_{ij})$ as follows. The top $n \times n$ part of \tilde{B} is the signed adjacency matrix B_T , with rows and columns indexed by arcs $\gamma \in T$. The bottom m rows are formed by the shear coordinates of the laminations L_i with respect to T :

$$b_{n+i, \gamma} = b_\gamma(T, L_{n+i}) \quad \text{if } 1 \leq i \leq m.$$

By [FT08, Theorem 11.6], the matrices $\tilde{B}_{T, L}$ transform compatibly with mutation.

DEFINITION 2.25. Let γ be an arc in (S, M) . Denote by L_γ a lamination consisting of a single curve defined as follows. The curve L_γ runs along γ within a small neighborhood of it. If γ has an endpoint a on a (circular) component C of the boundary of S , then L_γ begins at a point $a' \in C$ located near a in the counterclockwise direction, and proceeds along γ as shown in Figure 2. If T is a triangulation, we let $L_T = (L_\gamma)_{\gamma \in T}$ be the multi-lamination consisting of elementary laminations associated with the arcs in T , and we call it the *multi-lamination associated with T* .

The following result comes from [FT08, Proposition 16.3].

PROPOSITION 2.26. Let T be a triangulation with signed adjacency matrix B_T . Let $L_T = (L_\gamma)_{\gamma \in T}$ be the multi-lamination associated with T . Then $\mathcal{A}(\tilde{B}_{T, L_T})$ is isomorphic to the cluster algebra with principal coefficients with respect to the matrix B_T ; that is, $\mathcal{A}_\bullet(B_T) \cong \mathcal{A}(\tilde{B}_{T, L_T})$.

2.4 Skein relations

In this subsection we review some results from [MW11].

DEFINITION 2.27. A *generalized arc* in (S, M) is a curve γ in S such that:

- (a) the endpoints of γ are in M ;
- (b) except for the endpoints, γ is disjoint from the boundary of S ; and
- (c) γ does not cut out a monogon or a bigon.

Note that we allow a generalized arc to cross itself a finite number of times. We consider generalized arcs up to isotopy (of immersed arcs). In particular, an isotopy cannot remove a contractible kink from a generalized arc.

DEFINITION 2.28. A *closed loop* in (S, M) is a closed curve γ in S which is disjoint from the boundary of S . We allow a closed loop to have a finite number of self-crossings. As in Definition 2.27, we consider closed loops up to isotopy.

DEFINITION 2.29. A closed loop in (S, M) is said to be *essential* if it is not contractible and does not have self-crossings.

DEFINITION 2.30 (Multicurve). We define a *multicurve* to be a finite multiset of generalized arcs and closed loops such that there are only a finite number of pairwise crossings among the collection. We say that a multicurve is *simple* if there are no pairwise crossings among the collection and no self-crossings.

If a multicurve is not simple, then there are two ways to *resolve* a crossing to obtain a multicurve that no longer contains this crossing and has no additional crossings. This process is known as *smoothing*.

DEFINITION 2.31 (Smoothing). Let γ, γ_1 and γ_2 be generalized arcs or closed loops such that we have one of the following two cases:

- (i) γ_1 crosses γ_2 at a point x ;
- (ii) γ has a self-crossing at a point x .

Then we let C be the multicurve $\{\gamma_1, \gamma_2\}$ or $\{\gamma\}$, depending on which of the two cases we are in. We define the *smoothing of C at the point x* to be the pair of multicurves $C_+ = \{\alpha_1, \alpha_2\}$ (respectively, $\{\alpha\}$) and $C_- = \{\beta_1, \beta_2\}$ (respectively, $\{\beta\}$).

Here, the multicurve C_+ (respectively, C_-) is the same as C except for the local change that replaces the crossing \times with the pair of segments $\begin{matrix} \cup \\ \cap \end{matrix}$ (respectively, $\supset\subset$).

See Figures 3 and 4 for the first case, and Figure 5 for the second case.

Since a multicurve may contain only a finite number of crossings, by repeatedly applying smoothings we can associate to any multicurve a collection of simple multicurves. We call this resulting multiset of multicurves the *smooth resolution* of the multicurve C .

THEOREM 2.32 [MW11, Propositions 6.4, 6.5, 6.6]. *Let C, C_+ and C_- be as in Definition 2.31. Then we have the following identity in $\mathcal{A}_\bullet(B_T)$:*

$$x_C = \pm Y_1 x_{C_+} \pm Y_2 x_{C_-},$$

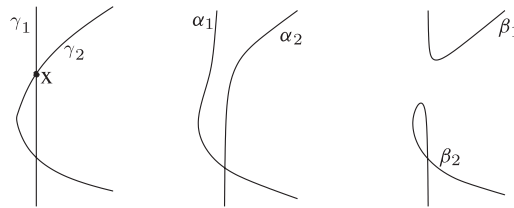

FIGURE 3. Smoothing of two generalized arcs.

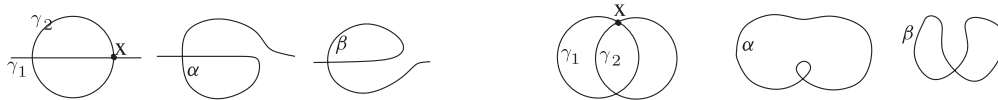

FIGURE 4. Smoothing of two curves where at least one is a loop.

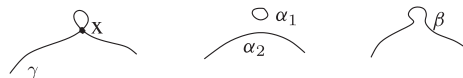

FIGURE 5. Smoothing of a self-intersection.

where Y_1 and Y_2 are monomials in the variables y_{τ_i} . The monomials Y_1 and Y_2 can be expressed using the intersection numbers of the elementary laminations (associated to the triangulation T) with the curves in C , C_+ and C_- .

2.5 Chebyshev polynomials

Chebyshev polynomials will play an important role in the proof of our main result. In this subsection, we recall some basic facts.

DEFINITION 2.33. Let T_k denote the k th normalized Chebyshev polynomial with coefficients defined by

$$T_k\left(t + \frac{Y}{t}\right) = t^k + \frac{Y^k}{t^k}.$$

PROPOSITION 2.34. The normalized Chebyshev polynomials $T_k(x)$ defined above can also be uniquely determined by the initial conditions $T_0(x) = 2$, $T_1(x) = x$ and the recurrence relation

$$T_k(x) = xT_{k-1}(x) - YT_{k-2}(x).$$

If Y is set to be 1, then the $T_k(x)$'s can also be written as $2 \text{Cheb}_k(x/2)$, where $\text{Cheb}_k(x)$ denotes the usual Chebyshev polynomial of the first kind, which satisfies $\text{Cheb}_k(\cos x) = \cos(kx)$.

Proof. It is easy to check that the unique one-parameter family of polynomials $T_k(x)$ defined by the property $T_k(t + Y/t) = t^k + Y^k/t^k$ satisfies the initial conditions $T_0(x) = 2$ and $T_1(x) = x$. To see that this family also satisfies the desired recurrence relation, we note that

$$\left(t + \frac{Y}{t}\right) \left(t^{k-1} + \frac{Y^{k-1}}{t^{k-1}}\right) = t^k + Yt^{k-2} + \frac{Y^{k-1}}{t^{k-2}} + \frac{Y^k}{t^k},$$

TABLE 1. The normalized Chebyshev polynomials (with coefficients) $T_k(x)$ for small k .

$T_0(x) = 2$
$T_1(x) = x$
$T_2(x) = x^2 - 2Y$
$T_3(x) = x^3 - 3xY$
$T_4(x) = x^4 - 4x^2Y + 2Y^2$
$T_5(x) = x^5 - 5x^3Y + 5xY^2$
$T_6(x) = x^6 - 6x^4Y + 9x^2Y^2 - 2Y^3$

and thus, letting $x = t + Y/t$, we obtain

$$xT_{k-1}(x) = T_k(x) + YT_{k-2}(x).$$

Since the usual Chebyshev polynomials satisfy the initial conditions $\text{Cheb}_0(x) = 1$, $\text{Cheb}_1(x) = x$ and the recurrence relation

$$\text{Cheb}_k(x) = 2x \text{Cheb}_{k-1}(x) - \text{Cheb}_{k-2}(x),$$

the last remark follows as well. □

We record here one more property of the normalized Chebyshev polynomials that we will need later.

PROPOSITION 2.35. *For all $k \geq 1$, the monomial x^k can be written as a positive linear combination of the normalized Chebyshev polynomials $T_k = T_k(x)$. In particular,*

$$x^k = T_k + \binom{k}{1}YT_{k-2} + \dots + \binom{k}{(k-1)/2}Y^{(k-2)/2}T_1 \quad \text{if } k \text{ is odd} \tag{2.13}$$

and

$$x^k = T_k + \binom{k}{1}YT_{k-2} + \dots + \binom{k}{(k-2)/2}Y^{(k-2)/2}T_2 + \binom{k}{k/2}Y^{k/2} \quad \text{if } k \text{ is even.} \tag{2.14}$$

Proof. We prove both of these identities together by induction on k . The base cases for $k = 1$ or 2 are easy to verify. If $k \geq 3$ is odd, then by induction and equation (2.14) we obtain

$$\begin{aligned} x^k &= x(x^{k-1}) \\ &= x \left[T_{k-1} + \binom{k-1}{1}YT_{k-3} + \dots + \binom{k-1}{(k-3)/2}Y^{(k-3)/2}T_2 + \binom{k-1}{(k-1)/2}Y^{(k-1)/2} \right]. \end{aligned}$$

The Chebyshev recurrence can be rewritten as $xT_{k-1} = T_k + YT_{k-2}$. Thus x^k equals

$$\begin{aligned} &\left[T_k + \binom{k-1}{1}YT_{k-2} + \binom{k-1}{2}Y^2T_{k-4} + \dots + \binom{k-1}{(k-3)/2}Y^{(k-3)/2}T_3 \right] \\ &+ \binom{k-1}{(k-1)/2}Y^{(k-1)/2}x \\ &+ Y \left[T_{k-2} + \binom{k-1}{1}YT_{k-4} + \binom{k-1}{2}Y^2T_{k-6} + \dots + \binom{k-1}{(k-3)/2}Y^{(k-3)/2}T_1 \right] \end{aligned}$$

$$\begin{aligned}
 &= T_k + \binom{k}{1} Y T_{k-2} + \binom{k}{2} Y^2 T_{k-4} + \cdots + \binom{k}{(k-3)/2} Y^{(k-3)/2} T_3 \\
 &\quad + \binom{k}{(k-1)/2} Y^{(k-1)/2} T_1,
 \end{aligned}$$

where the last equality uses the fact that $x = T_1$.

A similar technique proves the identity for the case of even k , where we need to use the facts that $T_0 = 2$ and $2\binom{k-1}{(k-2)/2} = \binom{k}{k/2}$. Using these and (2.13), the monomial $x^k = x(x^{k-1})$ equals

$$\begin{aligned}
 &\left[T_k + \binom{k-1}{1} Y T_{k-2} + \binom{k-1}{2} Y^2 T_{k-4} + \cdots + \binom{k-1}{(k-4)/2} Y^{(k-4)/2} T_4 \right. \\
 &\quad \left. + \binom{k-1}{(k-2)/2} Y^{(k-2)/2} T_2 \right] + Y \left[T_{k-2} + \binom{k-1}{1} Y T_{k-4} \right. \\
 &\quad \left. + \binom{k-1}{2} Y^2 T_{k-6} + \cdots + \binom{k-1}{(k-4)/2} Y^{(k-4)/2} T_2 + \binom{k-1}{(k-2)/2} Y^{(k-2)/2} T_0 \right] \\
 &= T_k + \binom{k}{1} Y T_{k-2} + \binom{k}{2} Y^2 T_{k-4} + \cdots + \binom{k}{(k-2)/2} Y^{(k-2)/2} T_2 + \binom{k}{k/2} Y^{k/2}. \quad \square
 \end{aligned}$$

3. Definition of the two bases \mathcal{B}° and \mathcal{B}

Throughout §§3–7 of this paper, we fix an unpunctured marked surface (S, M) and a triangulation T , and consider the corresponding cluster algebra $\mathcal{A} = \mathcal{A}_\bullet(B_T)$, with principal coefficients with respect to T . Recall that the cluster variables of \mathcal{A} are in bijection with the arcs in (S, M) . In this paper we will associate elements of \mathcal{A} to any *generalized* arc (where self-intersections are allowed) and to any closed loop. In particular, we will define two sets $\mathcal{C}^\circ(S, M)$ and $\mathcal{C}(S, M)$ of collections of loops and arcs in (S, M) , and will associate a cluster algebra element to each element of $\mathcal{C}^\circ(S, M)$ and $\mathcal{C}(S, M)$.

3.1 Snake graphs and band graphs

Recall from [MSW11] that we have a positive combinatorial formula for the Laurent expansion of any cluster variable in a cluster algebra arising from a surface. Each such cluster variable corresponds to an arc in the surface, so our formula associates a cluster algebra element to every arc. We will generalize this construction and associate cluster algebra elements to *generalized* arcs as well as to closed loops (with or without self-crossings).

Let γ be an arc in (S, M) which is not in T . Choose an orientation on γ , let $s \in M$ be its starting point, and let $t \in M$ be its endpoint. We denote by $s = p_0, p_1, p_2, \dots, p_{d+1} = t$ the points of intersection of γ and T in order. Let τ_{i_j} be the arc of T containing p_j , and let Δ_{j-1} and Δ_j be the two triangles in T on either side of τ_{i_j} . Note that each of these triangles has three distinct sides but not necessarily three distinct vertices; see Figure 6.

Let G_j be the graph with four vertices and five edges, having the shape of a square with a diagonal, such that there is a bijection between the edges of G_j and the five arcs in the two triangles Δ_{j-1} and Δ_j which preserves the signed adjacency of the arcs up to sign and is such that the diagonal in G_j corresponds to the arc τ_{i_j} containing the crossing point p_j . We call the graph G_j a *tile*. Thus the tile G_j is given by the quadrilateral in the triangulation T whose diagonal is τ_{i_j} .

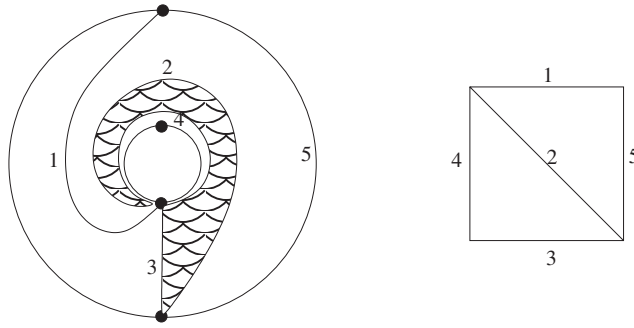

FIGURE 6. On the left: a triangle with two vertices. On the right: the tile G_j where $i_j = 2$.

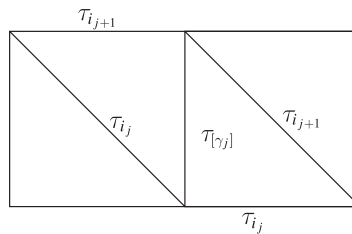

FIGURE 7. Gluing tiles \tilde{G}_j and \tilde{G}_{j+1} along the edge labeled $\tau_{[\gamma_j]}$.

DEFINITION 3.1. Given a planar embedding \tilde{G}_j of a tile G_j , we define the *relative orientation* $\text{rel}(\tilde{G}_j, T)$ of \tilde{G}_j with respect to T to be ± 1 , based on whether its triangles agree or disagree in orientation with those of T .

For example, in Figure 6, the tile G_j has relative orientation $+1$.

Using the notation above, the arcs τ_{i_j} and $\tau_{i_{j+1}}$ form two edges of a triangle Δ_j in T . Define $\tau_{[\gamma_j]}$ to be the third arc in this triangle.

We now recursively glue together the tiles G_1, \dots, G_d in order from 1 to d , so that for two adjacent tiles we glue G_{j+1} to G_j along the edge labeled $\tau_{[\gamma_j]}$, choosing a planar embedding \tilde{G}_{j+1} for G_{j+1} such that $\text{rel}(\tilde{G}_{j+1}, T) \neq \text{rel}(\tilde{G}_j, T)$. See Figure 7.

After gluing together the d tiles, we obtain a graph (embedded in the plane), which we denote by \overline{G}_γ .

DEFINITION 3.2. The *snake graph* G_γ associated to γ is obtained from \overline{G}_γ by removing the diagonal in each tile.

In Figure 8, we give an example of an arc γ and the corresponding snake graph G_γ . Since γ intersects T five times, G_γ has five tiles.

Remark 3.3. Even if γ is a generalized arc, thus allowing self-crossings, we can still define G_γ in the same way.

Now we associate a similar graph to closed loops. Let ζ be a closed loop in (S, M) , which may or may not have self-intersections, that is not contractible and has no contractible kinks. Choose an orientation for ζ , and choose a triangle Δ which is crossed by γ . Let p be a point in the interior of Δ which lies on γ , and let b and c be the two sides of the triangle crossed by γ

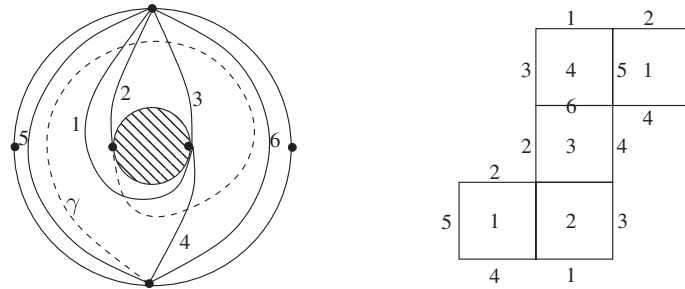

FIGURE 8. On the left: an arc γ in a triangulated annulus. On the right: the corresponding snake graph G_γ ; the tiles labeled 1 or 3 have positive relative orientation, while the tiles labeled 2 or 4 have negative relative orientation.

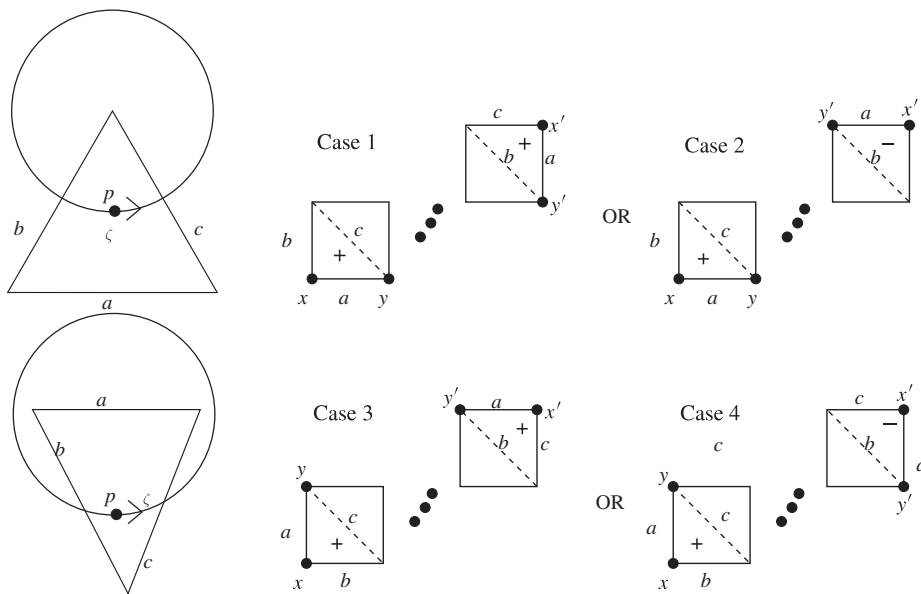

FIGURE 9. On the left: triangle containing p along the closed loop ζ . On the right: the corresponding band graph (with $x \sim x'$ and $y \sim y'$), depending on whether γ crosses an odd or even number of arcs; the + and - symbols indicate the relative orientation of each tile.

immediately before and following its travel through the point p . Let a be the third side of Δ . We let $\tilde{\gamma}$ denote the arc from p back to itself that exactly follows the closed loop γ . See the leftmost diagram of Figure 9.

We start by building the snake graph $G_{\tilde{\gamma}}$ as defined above. In the first tile of $G_{\tilde{\gamma}}$, let x denote the vertex at the corner of the edge labeled a and the edge labeled b , and let y denote the vertex at the other end of the edge labeled a . Similarly, in the last tile of $G_{\tilde{\gamma}}$, let x' denote the vertex at the corner of the edge labeled a and the edge labeled c , and let y' denote the vertex at the other end of the edge labeled a . See the right part of Figure 9.

DEFINITION 3.4. The *band graph* \tilde{G}_ζ associated to the loop ζ is the graph obtained from $G_{\tilde{\gamma}}$ by identifying the edges labeled a in the first and last tiles so that the vertices x and x' and the vertices y and y' are glued together. We refer to the two vertices obtained by identification as x

and y , and to the edge obtained by identification as the *cut edge*. The resulting graph lies on an annulus or a Möbius strip.

3.2 Laurent polynomials associated to generalized arcs and closed loops

Recall that if τ is a boundary segment, then $x_\tau = 1$,

DEFINITION 3.5. If γ is a generalized arc or closed loop and $\tau_{i_1}, \tau_{i_2}, \dots, \tau_{i_d}$ is the sequence of arcs in T which γ crosses, we define the *crossing monomial* of γ with respect to T to be

$$\text{cross}(T, \gamma) = \prod_{j=1}^d x_{\tau_{i_j}}.$$

DEFINITION 3.6. A *perfect matching* of a graph G is a subset P of the edges of G such that each vertex of G is incident to exactly one edge of P . If G is a snake graph or band graph, and if the edges of a perfect matching P of G are labeled $\tau_{j_1}, \dots, \tau_{j_r}$, then we define the *weight* $x(P)$ of P to be $x_{\tau_{j_1}}, \dots, x_{\tau_{j_r}}$.

DEFINITION 3.7. Let γ be a generalized arc. It is easy to see that the snake graph G_γ has precisely two perfect matchings, which we call the *minimal matching* $P_- = P_-(G_\gamma)$ and the *maximal matching* $P_+ = P_+(G_\gamma)$, that contain only boundary edges. To distinguish them, if $\text{rel}(\tilde{G}_1, T) = 1$ (respectively, $\text{rel}(\tilde{G}_1, T) = -1$), we define e_1 and e_2 to be the two edges of \tilde{G}_γ which lie in the counterclockwise (respectively, clockwise) direction from the diagonal of \tilde{G}_1 . Then P_- is defined as the unique matching which contains only boundary edges and does not contain edges e_1 or e_2 , while P_+ is the other matching with only boundary edges.

In the example of Figure 8, the minimal matching P_- contains the bottom edge of the first tile labeled 4.

DEFINITION 3.8. Let ζ be a closed loop. A perfect matching P of the band graph \tilde{G}_ζ is called a *good matching* if either x and y are matched to each other (i.e. $P(x) = y$ and $P(y) = x$) or both edges $(x, P(x))$ and $(y, P(y))$ lie on one side of the cut edge.

Remark 3.9. Let \tilde{G}_ζ be a band graph obtained by identifying two edges of the snake graph $G_{\tilde{\zeta}}$. The good matchings of \tilde{G}_ζ can be identified with a subset of the perfect matchings of $G_{\tilde{\zeta}}$. Let \tilde{P} be a good matching of \tilde{G}_ζ . Thinking of \tilde{P} as a subset of edges of $G_{\tilde{\zeta}}$, by the definition of ‘good’ we can add to it either the edge (x, y) or the edge (x', y') to get a perfect matching P of $G_{\tilde{\zeta}}$. In this case, we say that the perfect matching P of $G_{\tilde{\zeta}}$ *descends* to a good matching \tilde{P} of \tilde{G}_ζ . In particular, the minimal matching P_- of $G_{\tilde{\zeta}}$ descends to a good matching of \tilde{G}_ζ , which we will also refer to as *minimal*. (To see this, just consider the cases of $G_{\tilde{\zeta}}$ having an odd or even number of tiles, and observe that the minimal matching of $G_{\tilde{\zeta}}$ always uses one of the edges (x, y) and (x', y') .)

For an arbitrary perfect matching P of a snake graph G_γ , we let $P_- \ominus P$ denote the symmetric difference, defined as $P_- \ominus P = (P_- \cup P) \setminus (P_- \cap P)$.

LEMMA 3.10 [MS10, Theorem 5.1]. *The set $P_- \ominus P$ is the set of boundary edges of a (possibly disconnected) subgraph G_P of G_γ which is a union of cycles. These cycles enclose a set of tiles $\bigcup_{j \in J} G_j$, where J is a finite index set.*

We use this decomposition to define *height monomials* for perfect matchings. Note that the exponents in the height monomials defined below coincide with the definition of height functions given in [Pro02] for perfect matchings of bipartite graphs, based on earlier work of [CL90, EKLP92, Thu90] for domino tilings.

DEFINITION 3.11. With the notation of Lemma 3.10, we define the *height monomial* $y(P)$ of a perfect matching P of a snake graph G_γ by

$$y(P) = \prod_{j \in J} y_{\tau_{i_j}}.$$

The *height monomial* $y(\tilde{P})$ of a good matching \tilde{P} of a band graph \tilde{G}_ζ is defined to be the height monomial of the corresponding matching on the snake graph $G_{\tilde{\zeta}}$.

For each generalized arc γ , we now define a Laurent polynomial x_γ , as well as a polynomial F_γ^T obtained from x_γ by specialization.

DEFINITION 3.12. Let γ be a generalized arc, and let G_γ be its snake graph.

(i) If γ has a contractible kink, let $\bar{\gamma}$ denote the corresponding generalized arc with this kink removed, and define $x_\gamma = (-1)x_{\bar{\gamma}}$.

(ii) Otherwise, define

$$x_\gamma = \frac{1}{\text{cross}(T, \gamma)} \sum_P x(P)y(P),$$

where the sum is over all perfect matchings P of G_γ .

Define F_γ^T to be the polynomial obtained from x_γ by specializing all the x_{τ_i} to 1.

If γ is a curve that cuts out a contractible monogon, then we define $x_\gamma = 0$.

THEOREM 3.13 [MSW11, Theorem 4.9]. *If γ is an arc, then x_γ is the Laurent expansion with respect to the seed Σ_T of the cluster variable in \mathcal{A} corresponding to the arc γ , and F_γ^T is its F -polynomial.*

For every closed loop ζ , we now define a Laurent polynomial x_ζ , as well as a polynomial F_ζ^T obtained from x_ζ by specialization.

DEFINITION 3.14. Let ζ be a closed loop.

(i) If ζ is a contractible loop, then let $x_\zeta = -2$.

(ii) If ζ has a contractible kink, let $\bar{\zeta}$ denote the corresponding closed loop with this kink removed, and define $x_\zeta = (-1)x_{\bar{\zeta}}$.

(iii) Otherwise, let

$$x_\zeta = \frac{1}{\text{cross}(T, \zeta)} \sum_P x(P)y(P),$$

where the sum is over all good matchings P of the band graph \tilde{G}_ζ .

Define F_ζ^T to be the Laurent polynomial obtained from x_ζ by specializing all the x_{τ_i} to 1.

Remark 3.15. Note that x_γ depends on the triangulation T and the surface (S, M) , and it lies in (the fraction field of) $\mathcal{A}_\bullet(B_T)$. If we want to emphasize the dependence on T , we will use the notation X_γ^T instead of x_γ ; similarly for X_ζ^T and x_ζ .

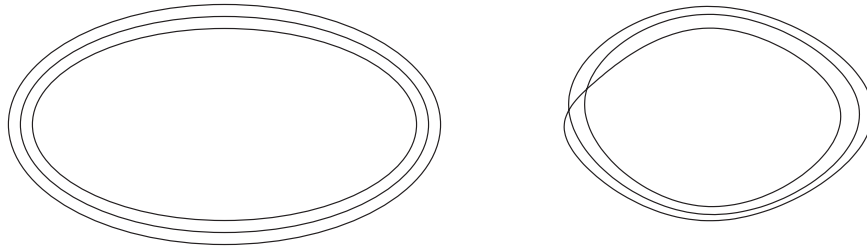

FIGURE 10. A bangle $\text{Bang}_3 \zeta$ (left) and a bracelet $\text{Brac}_3 \zeta$ (right).

3.3 Bangles and bracelets

DEFINITION 3.16. Let ζ be an essential loop in (S, M) . We define the *bangle* $\text{Bang}_k \zeta$ to be the union of k loops isotopic to ζ . (Note that $\text{Bang}_k \zeta$ has no self-crossings.) We define the *bracelet* $\text{Brac}_k \zeta$ to be the closed loop obtained by concatenating ζ exactly k times; see Figure 10. (Note that $\text{Brac}_k \zeta$ will have $k - 1$ self-crossings.)

Note that $\text{Bang}_1 \zeta = \text{Brac}_1 \zeta = \zeta$.

DEFINITION 3.17. A collection C of arcs and essential loops is said to be \mathcal{C}° -compatible if no two elements of C cross each other. We define $\mathcal{C}^\circ(S, M)$ to be the set of all \mathcal{C}° -compatible collections in (S, M) .

DEFINITION 3.18. A collection C of arcs and bracelets is said to be \mathcal{C} -compatible if:

- no two elements of C cross each other, except for the self-crossings of a bracelet; and
- given an essential loop ζ in (S, M) , there is at most one $k \geq 1$ such that the k th bracelet $\text{Brac}_k \zeta$ lies in C , and, moreover, there is at most one copy of this bracelet $\text{Brac}_k \zeta$ in C .

We define $\mathcal{C}(S, M)$ to be the set of all \mathcal{C} -compatible collections in (S, M) .

Note that a \mathcal{C}° -compatible collection may contain bangles $\text{Bang}_k \zeta$ for $k \geq 1$, but it will not contain bracelets $\text{Brac}_k \zeta$ except when $k = 1$. Also, a \mathcal{C} -compatible collection may contain bracelets but will never contain a bangle $\text{Bang}_k \zeta$ except when $k = 1$.

DEFINITION 3.19. Given an arc or a closed loop c , let x_c denote the corresponding Laurent polynomial defined in §3.2. We define \mathcal{B}° to be the set of all cluster algebra elements in $\mathcal{A} = \mathcal{A}_\bullet(B_T)$ corresponding to the set $\mathcal{C}^\circ(S, M)$; that is,

$$\mathcal{B}^\circ = \left\{ \prod_{c \in C} x_c \mid C \in \mathcal{C}^\circ(S, M) \right\}.$$

Similarly, we define

$$\mathcal{B} = \left\{ \prod_{c \in C} x_c \mid C \in \mathcal{C}(S, M) \right\}.$$

Remark 3.20. Both \mathcal{B}° and \mathcal{B} contain the cluster monomials of \mathcal{A} .

Remark 3.21. The notation \mathcal{C}° is meant to remind the reader that this collection includes bangles. We chose to use the unadorned notation \mathcal{C} for the other collection of arcs and loops, because the corresponding set \mathcal{B} of cluster algebra elements is believed to have better positivity properties than does the set \mathcal{B}° .

4. Proof of the main result

The goal of this section is to prove that both sets \mathcal{B}° and \mathcal{B} are bases for the cluster algebra \mathcal{A} . More specifically, we will prove the following theorem.

THEOREM 4.1. *If the surface has no punctures and at least two marked points, then the sets \mathcal{B}° and \mathcal{B} are bases of the cluster algebra \mathcal{A} .*

We subdivide the proof into the following three steps.

- (i) \mathcal{B}° and \mathcal{B} are subsets of \mathcal{A} .
- (ii) \mathcal{B}° and \mathcal{B} are spanning sets for \mathcal{A} .
- (iii) \mathcal{B}° and \mathcal{B} are linearly independent.

4.1 \mathcal{B}° and \mathcal{B} are subsets of \mathcal{A}

We start by describing the relation between bangles and bracelets, which involves the Chebyshev polynomials.

If τ and ζ are arcs or closed loops and L is a lamination, we let $e(\tau, \zeta)$ (respectively, $e(\tau, L)$) denote the number of crossings between τ and ζ (respectively, τ and L).

PROPOSITION 4.2. *Let ζ be an essential loop, and let $Y_\zeta = \prod_{\tau \in T} y_\tau^{e(\zeta, \tau)}$. Then we have*

$$x_{\text{Brac}_k \zeta} = T_k(x_\zeta),$$

where T_k denotes the k th normalized Chebyshev polynomial (with coefficients) defined in § 2.5.

Proof. We prove the statement by induction on k . Smoothing $\text{Brac}_{k+1} \zeta$ at one point of self-crossing produces the multicurves $\{\zeta, \text{Brac}_k \zeta\}$ and $\{\gamma\}$, where γ is the curve Brac_{k-1} with a contractible kink. It follows from Theorem 2.32 that

$$x_{\text{Brac}_{k+1} \zeta} = \pm x_\zeta x_{\text{Brac}_k \zeta} \prod_{i=1}^n y_i^{(c_i - a_i)/2} \pm x_{\text{Brac}_{k-1} \zeta} \prod_{i=1}^n y_i^{(c_i - b_i)/2},$$

where $c_i = e(\text{Brac}_{k+1} \zeta, L_i)$, $a_i = e(\text{Brac}_k \zeta, L_i) + e(\zeta, L_i)$ and $b_i = e(\text{Brac}_{k-1} \zeta, L_i)$. From the definition of bracelets, it follows that $c_i = a_i$ and that $c_i = b_i + 2e(\zeta, \tau_i)$. Thus

$$x_{\text{Brac}_{k+1} \zeta} = \pm x_\zeta x_{\text{Brac}_k \zeta} \pm x_{\text{Brac}_{k-1} \zeta} Y_\zeta.$$

It remains to show that the first sign is + and the second is -.

Since $k \geq 1$, each of x_ζ , $x_{\text{Brac}_k \zeta}$ and $x_{\text{Brac}_{k+1} \zeta}$ is a Laurent polynomial given by a band graph formula. So, in particular, each is in $\mathbb{Z}[x_i^{\pm 1}, y_i]$, has all signs positive, and has a unique term without any coefficients y_i , corresponding to the minimal matching. On the other hand, Y_ζ is a monomial in the y_i 's which is not equal to 1. If we set all the x_i 's equal to 1 and all the y_i 's equal to 0, then we get $1 = \pm 1 \pm 0$, which shows that the first sign must be +.

To see that the second sign is -, we use Definition 3.14 and the specialization $x_i = 1$ and $y_i = 1$ for all i . Letting $\text{Good}(G)$ denote the set of good matchings of G and using $\tilde{G}_{m\zeta}$ as a shorthand for the band graph $\tilde{G}_{\text{Brac}_m \zeta}$, our equation becomes

$$|\text{Good}(\tilde{G}_{(k+1)\zeta})| = +|\text{Good}(\tilde{G}_\zeta)| \cdot |\text{Good}(\tilde{G}_{k\zeta})| \pm |\text{Good}(\tilde{G}_{(k-1)\zeta})|.$$

Thus it suffices to show that

$$|\text{Good}(\tilde{G}_{(k+1)\zeta})| < |\text{Good}(\tilde{G}_\zeta)| \cdot |\text{Good}(\tilde{G}_{k\zeta})|.$$

For $d \geq 2$, we let $\bullet_{y'} \text{---} \bullet_{x'}$ denote the edge of the snake graph $G_{d\zeta}$ or the band graph $\tilde{G}_{d\zeta}$ succeeding the last tile of the subgraph G_ζ . We will exhibit an injective map $\psi : \text{Good}(\tilde{G}_{(k+1)\zeta}) \rightarrow \text{Good}(\tilde{G}_\zeta) \times \text{Good}(\tilde{G}_{k\zeta})$. In particular, given $\tilde{P} \in \text{Good}(\tilde{G}_{(k+1)\zeta})$, we define $\psi(\tilde{P}) = (\tilde{Q}_1, \tilde{Q}_2)$ as follows.

- **Lift** \tilde{P} to P , a perfect matching of the snake graph $G_{(k+1)\zeta}$.
- **Split** P along the edge $\bullet_{y'} \text{---} \bullet_{x'}$ into perfect matchings P_1 and P_2 of the snake graphs G_ζ and $G_{k\zeta}$, respectively. Note that there are two cases here. If the edge $\bullet_{y'} \text{---} \bullet_{x'}$ is in P , we copy it, and include it as a distinguished edge in both P_1 and P_2 . Otherwise, either P_1 or P_2 is missing one edge to be a perfect matching, and we adjoin the edge $\bullet_{y'} \text{---} \bullet_{x'}$ to that perfect matching.
- **Swap**. Consider the symmetric difference $P_1 \ominus P_2$, which, by Lemma 3.10, consists of a union of cycles. Let C be the cycle which encloses the tile G_1 , if such a cycle exists, and let C be empty otherwise. We then define the *first segment* of both P_1 and P_2 to be the matching on the induced subgraph formed by the tiles enclosed by the cycle C . Swap the first segments of P_1 and P_2 to obtain new perfect matchings of G_ζ and $G_{k\zeta}$, which we denote by Q_1 and Q_2 .
- **Descend** Q_1 and Q_2 down to good matchings \tilde{Q}_1 and \tilde{Q}_2 of the band graphs \tilde{G}_ζ and $\tilde{G}_{k\zeta}$.

A straightforward analysis of nine possible cases (contingent on how the perfect matching P looks locally around edges $\bullet_x \text{---} \bullet_y$ and $\bullet_{y'} \text{---} \bullet_{x'}$) shows that the map ψ is well-defined and has a left-inverse. In particular, swapping the first segments of P_1 and P_2 turns the condition that \tilde{P} is a *good* matching of the band graph $\tilde{G}_{(k+1)\zeta}$ into the condition that \tilde{Q}_1 and \tilde{Q}_2 are *good* matchings of the band graphs \tilde{G}_ζ and $\tilde{G}_{k\zeta}$. □

Remark 4.3. In the special case where the cluster algebra \mathcal{A} has trivial coefficients, a similar formula can be found in [FG00].

Remark 4.4. In the special case where the surface is an annulus, Chebyshev polynomials were used in [Dup10, DT11] to construct an atomic basis for the cluster algebra.

Next, we show that the sets \mathcal{B}° and \mathcal{B} are subsets of the cluster algebra, using our assumption that the number of marked points is at least two. We do not know whether the result is true for surfaces with exactly one marked point.

PROPOSITION 4.5. *If the surface has at least two marked points, then the sets \mathcal{B}° and \mathcal{B} are subsets of \mathcal{A} .*

Proof. First, recall that if γ is an arc, then x_γ is a cluster variable by [MSW11]. Thus, if C is a multicurve consisting of non-crossing arcs, then x_C is a monomial of cluster variables, and hence $x_C \in \mathcal{A}$.

Next, suppose that ζ is an essential loop. Suppose first that there exists one boundary component which contains at least two marked points m_1 and m_2 . Let γ be the arc obtained by attaching the loop ζ to the point m_1 ; more precisely, γ is the isotopy class of the curve $\gamma_1\zeta\gamma_1^{-1}$, where γ_1 is a curve from m_1 to the starting point of ζ ; see Figure 11. Let γ' be the unique arc that crosses γ twice, connects the two immediate neighbors m_1^- and m_1^+ of m_1 on the boundary, and is homotopic to the part of the boundary component between m_1^- and m_1^+ . Note that m_1^- and m_1^+ coincide if this boundary component contains exactly two marked points. The multicurve $C = \{\gamma, \gamma'\}$ smoothes to the four simple multicurves shown in Figure 12, and it follows from

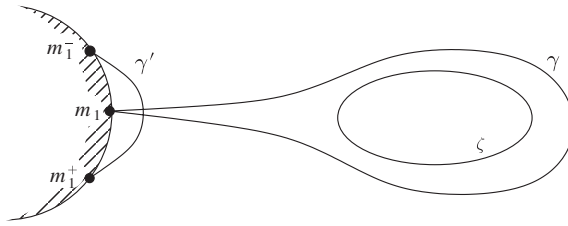

FIGURE 11. Two arcs γ and γ' associated to the essential loop ζ . The smoothing of the multicurve $\{\gamma, \gamma'\}$ is shown in Figure 12.

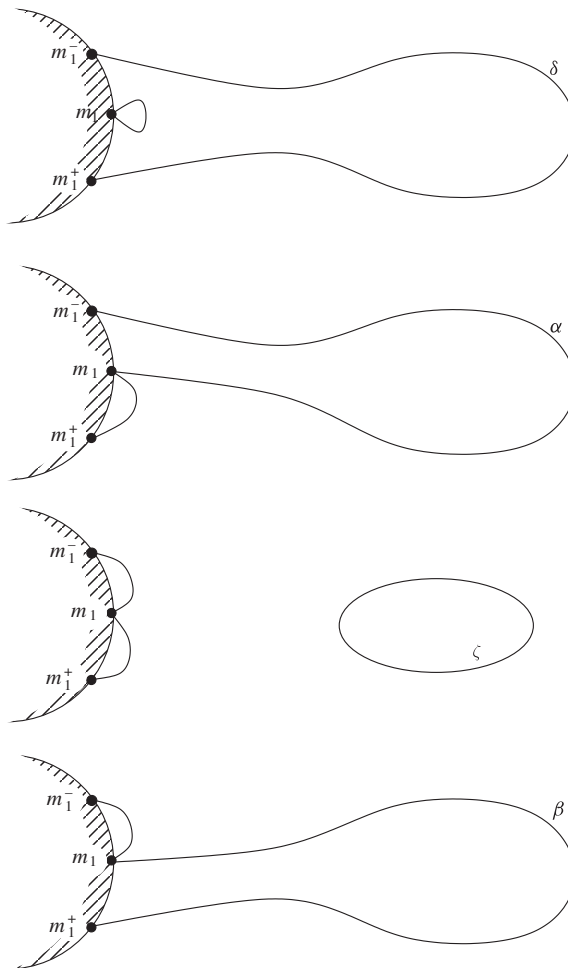

FIGURE 12. Smoothing of the multicurve $\{\gamma, \gamma'\}$ of Figure 11.

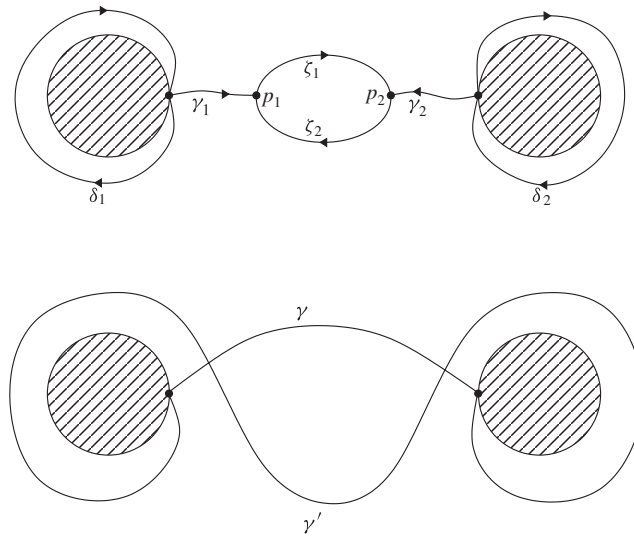

FIGURE 13. Two arcs γ and γ' associated to the essential loop ζ . The smoothing of the multicurve $\{\gamma, \gamma'\}$ is shown in Figure 14.

Theorem 2.32 that

$$x_\gamma x_{\gamma'} = 0 \pm y(\alpha : C)x_\alpha \pm y(\beta : C)x_\beta \pm y(\zeta : C)x_\zeta$$

for some coefficients $y(\alpha : C)$, $y(\beta : C)$ and $y(\gamma : C)$. Solving for x_ζ , we get

$$x_\zeta = (x_\gamma x_{\gamma'} \pm y(\alpha : C)x_\alpha \pm y(\beta : C)x_\beta) / y(\zeta : C),$$

which shows that $x_\zeta \in \mathcal{A}$.

Now suppose that each boundary component contains exactly one marked point. Then, by our assumption, there exist at least two such boundary components D_1 and D_2 . Let m_i denote the marked point on D_i . Choose two distinct points p_1 and p_2 on the loop ζ , fix an orientation of ζ , and denote by ζ_1 the segment of ζ from p_1 to p_2 and by ζ_2 the segment of ζ from p_2 to p_1 . Let γ_1 be a curve from m_1 to p_1 and γ_2 a curve from m_2 to p_2 . Define γ to be the arc homotopic to the concatenation $\gamma_1 \zeta_1 \gamma_2^{-1}$; see Figure 13.

To define γ' , we start with the arc from m_1 to m_2 given by $\gamma_1 \zeta_2^{-1} \gamma_2^{-1}$ and add to it a complete lap around each of the boundary components D_1 and D_2 in the directions that create crossings with γ . In Figure 13, γ' corresponds to the concatenation $\delta_1 \gamma_1 \zeta_2^{-1} \gamma_2^{-1} \delta_2$, where δ_i is a curve that starts and ends at m_i and goes around the boundary component D_i exactly once.

Then the multicurve $C = \{\gamma, \gamma'\}$ smoothes to the four simple multicurves shown in Figure 14, and again it follows from Theorem 2.32 that

$$x_\gamma x_{\gamma'} = \pm y(\zeta : C)x_\zeta \pm y(\alpha : C)x_\alpha \pm y(\beta : C)x_\beta \pm y(\{\sigma, \rho\} : C)x_\sigma x_\rho.$$

Again, solving for x_ζ shows that $x_\zeta \in \mathcal{A}$.

Thus, for every essential loop ζ the element x_ζ is in the cluster algebra. The element $x_{\text{Bang}_k \zeta}$ is a power of x_ζ , which shows that it also lies in the cluster algebra. This shows that $\mathcal{B}^\circ \subset \mathcal{A}$. Now Proposition 4.2 implies that $\mathcal{B} \subset \mathcal{A}$. □

COROLLARY 4.6. *If the surface has genus zero, then \mathcal{B}° and \mathcal{B} are subsets of \mathcal{A} .*

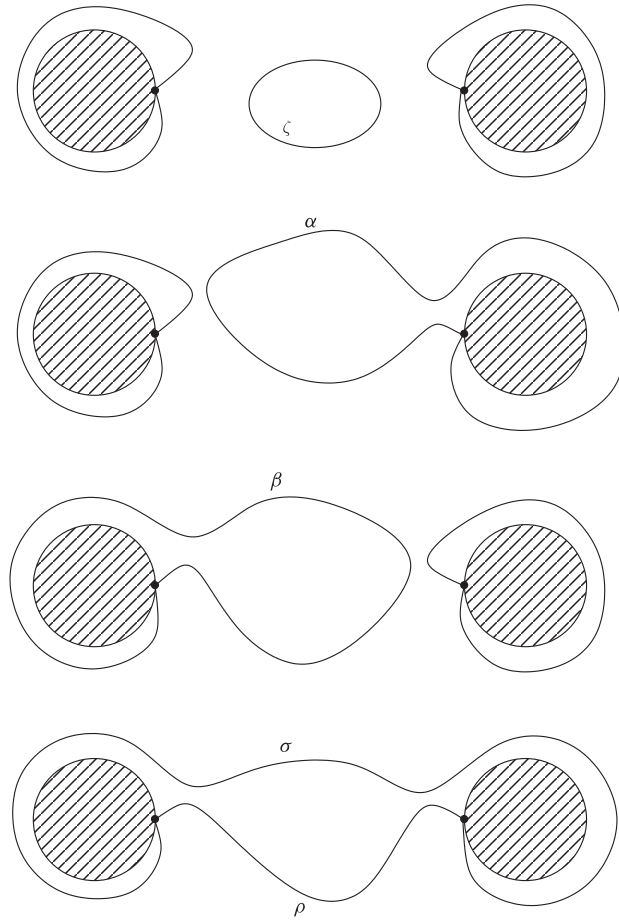

FIGURE 14. Smoothing of the multicurve $\{\gamma, \gamma'\}$ of Figure 13.

4.2 \mathcal{B}° and \mathcal{B} are spanning sets for \mathcal{A}

LEMMA 4.7. *The sets \mathcal{B}° and \mathcal{B} are both spanning sets for the cluster algebra \mathcal{A} .*

Proof. We start by showing the result for \mathcal{B}° . Since the elements of the cluster algebra are polynomials in the cluster variables, it suffices to show that any finite product of cluster variables can be written as a linear combination of elements of \mathcal{B}° .

We will prove the more general statement that for any multicurve C , the element $x_C = \prod_{c \in C} x_c$ can be written as a linear combination of elements of \mathcal{B}° . If there are no crossings between the elements of C , then $x_C \in \mathcal{B}^\circ$ and we are done. Suppose, therefore, that there are exactly d crossings between the elements of C . Using Theorem 2.32, we can write

$$x_C = \pm Y_+ x_{C_+} \pm Y_- x_{C_-}$$

where Y_+ and Y_- are coefficient monomials while C_+ and C_- are multicurves, each having at most $d - 1$ crossings between its elements. The statement for \mathcal{B}° now follows by induction.

To show the statement for \mathcal{B} , we use Propositions 2.35 and 4.2, which show that for each bangle $\text{Bang}_k \zeta$, we can write $x_{\text{Bang}_k \zeta}$ as a positive integer linear combination of elements of \mathcal{B} . Since \mathcal{B}° is a spanning set, it follows that \mathcal{B} is too. \square

Remark 4.8. While \mathcal{B} is expected to be an atomic basis, \mathcal{B}° is definitely not atomic. In particular, $x_{\text{Brack}} \zeta$ is in \mathcal{A}^+ (it expands positively in terms of every cluster), but its expansion in the basis \mathcal{B}° uses the polynomial $T_k(x)$, which has negative coefficients.

By comparing our construction of the basis \mathcal{B} with that of Fock and Goncharov, we obtain the following result.

COROLLARY 4.9. *For a coefficient-free cluster algebra \mathcal{A} from an unpunctured surface with at least two marked points, the upper cluster algebra and the cluster algebra coincide. Moreover, the sets \mathcal{B} and \mathcal{B}° are both bases of \mathcal{A} .*

Proof. It follows from [MW11, Theorem 4.11 and Proposition 4.12] that the set \mathcal{B} coincides with the basis of the upper cluster algebra constructed in [FG06]. Proposition 4.5 ensures that \mathcal{B} is a subset of the cluster algebra rather than simply the upper cluster algebra. Therefore \mathcal{B} is a basis for the cluster algebra and for the upper cluster algebra, and the two algebras coincide. \square

4.3 \mathcal{B}° and \mathcal{B} are linearly independent sets

It remains to show the linear independence of the sets \mathcal{B}° and \mathcal{B} . This is done in §§5 and 6.

5. Lattice structure of the matchings of snake and band graphs

In this section, we describe the structure of the set of perfect matchings of a snake graph and the set of good matchings of a band graph. The main application of our analysis of matchings is the proof of Theorem 5.1 below. In §6, we will use this theorem to extend the definition of \mathbf{g} -vector to all elements of \mathcal{B} and \mathcal{B}° .

THEOREM 5.1. *Any element z of \mathcal{B}° or \mathcal{B} contains a unique term \mathbf{x}^g not divisible by any coefficient variable, and the exponent vector of each other term is obtained from g by adding a non-negative linear combination of columns of \widetilde{B}_T . The same is true if we replace z by any product of elements in \mathcal{B}° or \mathcal{B} .*

Let G be a snake or band graph with tiles G_1, \dots, G_n . Let P_- denote the minimal matching of G . Given an arbitrary matching P of G , its *height function* or *height monomial* is the monomial $\prod_{G_i} w_i$ where G_i ranges over all tiles enclosed by $P \cup P_-$. We define a *twist* of a matching P to be a local move that affects precisely one tile T of G , replacing the two horizontal edges of T with the two vertical edges, or vice versa.

The following theorem is a consequence of [Pro02, Theorem 2]. See Figure 15.

THEOREM 5.2. *Consider the set of all perfect matchings of a snake graph G with tiles G_1, \dots, G_n . Construct a graph $L(G)$ whose vertices are labeled by these matchings and whose edges connect two vertices if and only if the two matchings are related by a twist. This graph is the Hasse diagram of a distributive lattice whose minimal element is P_- . The lattice is graded by the degree of each height monomial.*

We now prove some more properties of $L(G)$. We describe how to read off from G a poset Q_G whose lattice of order ideals $J(Q_G)$ is equal to $L(G)$.

Given a snake graph G , we define a *straight* subgraph of G to be a subgraph H formed by consecutive tiles which all lie in a row or in a column. We define a *zigzag* subgraph H of G to be a subgraph formed by consecutive tiles such that no three consecutive tiles in H lie in a row or in a column.

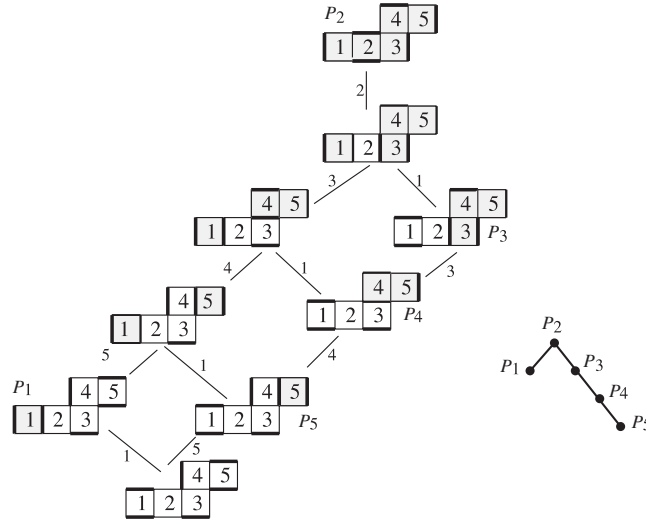

FIGURE 15. Lattice of perfect matchings of a snake graph.

DEFINITION 5.3. Let G be a snake graph with tiles G_1, \dots, G_n (labeled from southwest to northeast). Group the tiles of G into overlapping connected subsets of tiles S_1, \dots, S_k , where each S_i is either a maximal-by-inclusion straight or zigzag subgraph and the S_i alternate between straight and zigzag subgraphs. We associate to G (the Hasse diagram of) a poset $Q = Q_G$ as follows (see Figure 15). The elements of the poset are labeled P_1, \dots, P_n , and there is an edge in the Hasse diagram of Q between i and $i + 1$. Suppose that S_i consists of tiles G_r, G_{r+1}, \dots, G_s . If S_i is a zigzag subgraph, then the edges of the Hasse diagram between r and $r + 1$, $r + 1$ and $r + 2$, up to $s - 1$ and s , are either all oriented northeast or all oriented southeast. If S_i is a straight subgraph, then the edges of the Hasse diagram between i_1, \dots, i_r alternate between northeast and southeast orientations. If the tile G_2 is to the right of (respectively, above) the tile G_1 , then the edge from 1 and 2 is oriented northeast (respectively, southeast).

Note that the snake graph in Figure 15 is made up of a straight subgraph S_1 consisting of tiles G_1, \dots, G_3 and a zigzag subgraph S_2 consisting of tiles G_2, \dots, G_5 .

THEOREM 5.4. Let G be a snake graph with tiles G_1, \dots, G_n . We assume that the tile G_1 is chosen to have positive relative orientation (see Definition 3.1). Then $L(G)$ is the lattice of order ideals $J(Q_G)$ of the poset Q_G from Definition 5.3; the support of the height monomial of a matching in $L(G)$ consists precisely of the elements in the corresponding order ideal. Moreover, the twist-parity condition is satisfied: if i is odd (respectively, even), a twist on tile G_i going up in the poset replaces the horizontal edges in G_i with the vertical edges (respectively, the vertical edges with the horizontal edges).

Proof. We use induction on the number of tiles. If G is composed of tiles G_1, \dots, G_n , there are two cases: either G_n is to the right of G_{n-1} , or it is directly above tile G_{n-1} . We consider the first case here (the second case is similar, so we omit it). Let H_1 be the subgraph of G consisting of tiles G_1, \dots, G_{n-1} . Note that each perfect matching of H_1 can be extended uniquely to a perfect matching of G by adding the rightmost vertical edge of G_n ; we call such extended matchings *type 1* matchings of G . Now, consider perfect matchings of G which use the two horizontal edges

of G_n ; these we call *type 2* matchings. Recall the decomposition of G as a union of subgraphs S_1, \dots, S_k from Definition 5.3. Suppose that S_k consists of tiles G_r, G_{r+1}, \dots, G_n . If S_k is a zigzag subgraph, then type 2 perfect matchings will be forced to include every other edge of the boundary of $G_{r+1} \cup \dots \cup G_n$ and, indeed, will be in bijection with perfect matchings of the subgraph H_2 of G consisting of tiles G_1, \dots, G_{r-1} . If S_k is a straight subgraph, then type 2 perfect matchings will be in bijection with perfect matchings of the subgraph H_2 of G composed of tiles G_1, \dots, G_{n-2} .

In Figure 15, there are two type 2 perfect matchings, P_1 and the minimal element in the poset. These perfect matchings are in bijection with matchings of H_2 , which in this case consists of just tile G_1 . The other perfect matchings are of type 1.

The set of type 1 matchings forms a sublattice L_1 of $L(G)$ (isomorphic to $L(H_1)$), and the set of type 2 matchings forms a sublattice L_2 of $L(G)$ (isomorphic to $L(H_2)$). By induction, within L_1 and L_2 , the twist-parity condition is satisfied (note that within L_1 and L_2 there are no twists involving tile G_n). The lattice $L(G)$ is equal to the disjoint union of L_1 and L_2 together with some edges connecting them, which correspond to twists on tile G_n . If n is odd (respectively, even), then the minimal matching P_- of G uses one or both of the horizontal (respectively, vertical) edges of G_n . Therefore, when n is odd (respectively, even), if P is a matching of G which uses both horizontal (respectively, vertical) edges of G_n , then performing a twist will increase the height function. This proves the twist-parity condition.

To prove that $L(G) \cong J(Q_G)$, we use the decomposition $G = S_1 \cup \dots \cup S_k$. First, suppose that S_k is a straight subgraph. If n is even, then the type 1 matchings do not contain w_n in their height monomial, and by induction they are in bijection with order ideals in Q_{H_1} , i.e. order ideals of Q_G that do not use n . The type 2 matchings *do* contain w_n and also w_{n-1} in their height monomial, because S_k is straight and k is even. By induction, they are in bijection with order ideals in Q_{H_2} , which in turn are in bijection with order ideals of Q_G that involve n and $n - 1$. Together, this gives a decomposition of the order ideals of Q_G as a disjoint union of the type 1 and type 2 matchings, proving that $L(G) \cong J(Q_G)$. When n is odd the argument is similar, but this time it is the type 1 matchings whose height monomial contains w_n .

Now suppose that S_k is a zigzag subgraph. Write $S_k = G_r \cup G_{r+1} \cup \dots \cup G_n$. If n is even, then the type 1 matchings do not contain w_n in their height monomial, and by induction they are in bijection with order ideals in Q_{H_1} , which in turn are in bijection with order ideals of Q_G that do not use n . The type 2 matchings must contain w_r, w_{r+1}, \dots, w_n in their height monomials and, by induction, are in bijection with order ideals in Q_{H_2} , which in turn are in bijection with order ideals of Q_G that involve n (and hence $n - 1, n - 2, \dots, r$). Together, this gives a decomposition of the order ideals of Q_G as a disjoint union of the type 1 and type 2 matchings, which proves that $L(G)$ is isomorphic to $J(Q_G)$. When n is odd the argument is similar, but this time the height monomials of the type 1 matchings contain w_n , and the height monomials of the type 2 matchings do not contain any of w_r, w_{r+1}, \dots, w_n . □

Remark 5.5. If Q_T is the quiver of the triangulation T , then each generalized arc γ defines a string module $M(\gamma)$ over the corresponding Jacobian algebra; see [BZ10]. The string of $M(\gamma)$ is precisely the poset Q , and the lattice $L(G)$ is the lattice of string submodules of $M(\gamma)$.

We now consider the good matchings of a band graph \tilde{G} , where \tilde{G} is obtained from a snake graph G by identifying two edges. By Remark 3.9, we can identify the good matchings of \tilde{G} with a subset of the perfect matchings of G , so, in particular, we can consider the subgraph $L(\tilde{G})$ of $L(G)$ which is obtained from $L(G)$ by restricting to the good matchings. As we now

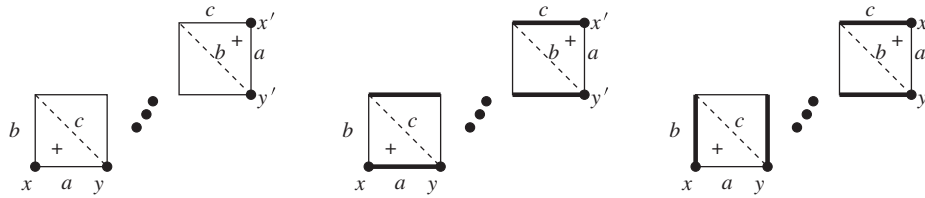

FIGURE 16. Illustration of the proof of Theorem 5.7.

explain, $L(\tilde{G})$ has the structure of a distributive lattice, that is, we can identify it with the lattice of order ideals of a certain poset.

DEFINITION 5.6. Let \tilde{G} be a band graph obtained from a snake graph G with tiles G_1, \dots, G_n . There are four different cases, based on the geometry of how x and y sit in the first and last tiles of \tilde{G} ; see Figure 9. Let $Q = Q_G$ be the poset associated to G by Definition 5.3. We now let $\tilde{Q} = \tilde{Q}_G$ be the poset obtained from the poset $Q = Q_G$ by imposing one more relation: in Cases 1 and 2, we impose the relation $1 > n$; in Cases 3 and 4, we impose the relation $1 < n$. (It is straightforward to verify that \tilde{Q} is still a well-defined poset.)

We have the following analogue of Theorem 5.4 for band graphs.

THEOREM 5.7. Let \tilde{G} be a band graph obtained from the snake graph G with tiles G_1, \dots, G_n . We assume that tile G_1 is chosen to have positive relative orientation. Then $L(\tilde{G})$ is the lattice of order ideals $J(\tilde{Q}_G)$ of the poset \tilde{Q}_G from Definition 5.6; the support of the height monomial of a matching in $L(\tilde{G})$ consists precisely of the elements in the corresponding order ideal. Since $L(\tilde{G})$ is a subgraph of $L(G)$, the twist-parity condition is satisfied.

Proof. While there are four cases to consider, the proofs in all cases are essentially the same, so we just give the proof in Case 1, where G and \tilde{G} are as in the left diagram of Figure 16 (so, in particular, G has an odd number of tiles). Then the minimal matching of G contains the edge between x and y and does *not* use the edge between x' and y' ; see the middle picture in Figure 16. Every perfect matching of G descends to a good matching of \tilde{G} , except for those which do not use either the edge between x and y or the edge between x' and y' ; see the picture on the right in Figure 16. Therefore the perfect matchings of G which do not descend to good matchings of \tilde{G} are precisely those whose height monomial contains w_1 but not w_n . Using the identification of perfect matchings of G with order ideals of Q_G , we see that the height monomials of good matchings of \tilde{G} can be identified with the order ideals of Q_G which use the element n whenever they use element 1. These are precisely the order ideals of \tilde{Q}_G . \square

See Figure 17 for the lattice of good matchings of a band graph \tilde{G} obtained from the snake graph G from Figure 15 by identifying the vertices x with x' and y with y' .

Remark 5.8. If Q_T is the quiver of the triangulation T , then each essential loop ζ defines a family of band modules $M_{\lambda,k}(\zeta)$, $\lambda \in \mathbb{P}^1$ and $k \geq 1$, over the corresponding Jacobian algebra; see [BZ10]. The band is precisely the poset Q , and the lattice $L(G)$ is the lattice of string submodules of $M_{\lambda,1}(\zeta)$ together with $M_{\lambda,1}(\zeta)$.

The bangle $\text{Bang}_k(\zeta)$ corresponds to the direct sum of k copies of $M_{\lambda,1}(\zeta)$. If the surface is a disk or an annulus, then the basis \mathcal{B}° corresponds to the generic basis in [Dup11, GLS11a].

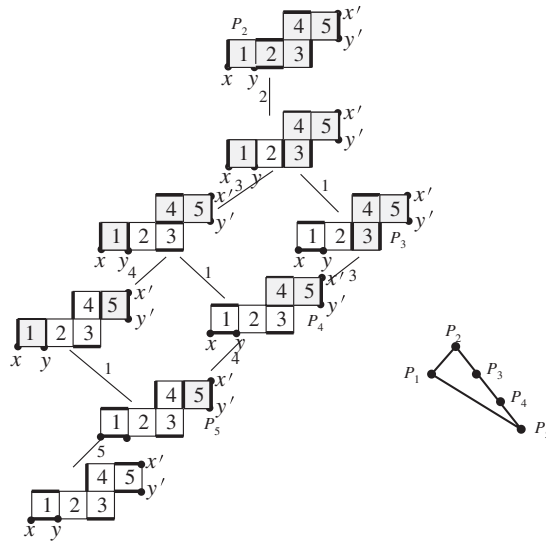

FIGURE 17. Lattice of good matchings of a band graph.

On the other hand, the bracelet $\text{Brac}_k(\zeta)$ does not have a module interpretation; it does *not* correspond to the band module $M_{\lambda,k}(\zeta)$.

Finally, we turn to the proof of Theorem 5.1.

Proof. Let $\tilde{B} = \tilde{B}_T$ be the extended exchange matrix. Note that if any two cluster algebra elements z_1 and z_2 satisfy the conditions of Theorem 5.1, then so does $z_1 z_2$. Therefore, it suffices to prove Theorem 5.1 for cluster variables and the cluster algebra elements associated to essential loops and bracelets. Theorem 5.1 for cluster variables follows from Proposition 2.10 and the fact that the F -polynomials of cluster variables from surfaces have constant term 1 (see [MSW11, § 13.1]).

By Definition 3.14, each cluster algebra element associated to a closed loop is a generating function for the good matchings of a band graph. By Theorem 5.7, there is a sequence of twists from the minimal matching P_- to any other good matching P of a band graph, where every twist is a cover relation going up in the poset. Moreover, the twist-parity condition holds: along this path, each twist on a tile of positive (respectively, negative) relative orientation will replace horizontal edges by vertical ones (respectively, vertical edges by horizontal ones). Finally, suppose that P_2 is a good matching obtained from P_1 by such a twist on tile G_i . Then it follows from our construction of band graphs that the exponent vector of $x(P_2)y(P_2)$ is equal to the exponent vector of $x(P_1)y(P_1)$ plus the i th column of \tilde{B} .

Note that similar arguments, together with Theorem 5.4, give a new proof of Theorem 5.1 for cluster variables associated to arcs. \square

6. The g-vector map and linear independence of \mathcal{B}^0 and \mathcal{B}

By Theorem 5.1 and Remark 2.12, each element of \mathcal{B} and \mathcal{B}^0 is homogeneous with respect to the \mathbf{g} -vector grading. The same is true for any product of elements from \mathcal{B} and \mathcal{B}^0 . This allows us to extend the definition of \mathbf{g} -vector to all elements of \mathcal{B} and \mathcal{B}^0 (and to all products of such elements).

DEFINITION 6.1. The \mathbf{g} -vector of any element x_C of \mathcal{B} or \mathcal{B}^0 , with respect to the seed T , is the multidegree of x_C , using the \mathbf{g} -vector grading. Additionally, for every collection $x_j, j \in J$, of elements of \mathcal{B} (or \mathcal{B}^0), we define $\mathbf{g}(\prod_j x_j) = \sum_j \mathbf{g}(x_j)$.

In Theorem 5.1, we have shown that every element of \mathcal{B}° and \mathcal{B} has a unique leading term. For arcs and essential loops, this leading term is given by the minimal matching P_- of the corresponding snake graph. Therefore, we can compute its \mathbf{g} -vector as follows.

PROPOSITION 6.2. Let γ be an arc or an essential loop. Then x_γ has a unique Laurent monomial $x(P_-)/\text{cross}(T, \gamma)$ which is not divisible by any coefficient variable y_{τ_i} . Moreover,

$$\mathbf{g}(x_\gamma) = \text{deg}\left(\frac{x(P_-)}{\text{cross}(T, \gamma)}\right),$$

where P_- is the minimal matching of the snake or band graph associated to γ and T , and $\text{cross}(T, \gamma)$ is the corresponding crossing monomial.

LEMMA 6.3. Let c_1 and c_2 be arcs or essential loops, and consider the skein relation in \mathcal{A} which writes $x_{c_1}x_{c_2} = \sum_i Y_i M_i$, where the M_i 's are elements of \mathcal{B}° and the Y_i 's are monomials in coefficient variables y_{τ_j} . Then there is a unique j such that $Y_j = 1$. As a consequence, for each $i \neq j$, the exponent vector of M_i is obtained from the exponent vector of M_j by adding a non-negative linear combination of columns of \widetilde{B}_T . We call the element M_j the leading term in the skein relation $x_{c_1}x_{c_2} = \sum_i Y_i M_i$.

Proof. The key to the proof is the observation that every skein relation which expresses a product of crossing arcs or loops in terms of arcs and loops that do not cross has a unique term on the right-hand-side with no coefficient variables. Once we have proved this observation, the existence and uniqueness of j follow. The relationship between $\mathbf{g}(M_i)$ and $\mathbf{g}(M_j)$ is then a consequence of the fact that elements of \mathcal{B}° are homogeneous with respect to the \mathbf{g} -vector grading (see Theorem 5.1), which implies that every term in the equation $x_{c_1}x_{c_2} = \sum_i Y_i M_i$ must have the same \mathbf{g} -vector.

It remains to verify the observation above. Theorem 2.32 implies that the skein relations have the form

$$H_1 = \pm Y_2 H_2 \pm Y_3 H_3,$$

where Y_2 and Y_3 are monomials in the coefficient variables and each H_i represents the product of one or two cluster algebra elements, with those elements given by our snake and band graph formulas. In particular, each H_i is in $\mathbb{Z}[x_i^{\pm 1}, y_i]$, has all coefficients positive, and has a unique term that is not divisible by any of the y_i .

It follows from [Thu, Lemma 7] and Theorem 2.32 that at least one of Y_2 and Y_3 is equal to 1. For the sake of contradiction, suppose that both of them are equal to 1. In that case, we have

$$H_1 = \pm H_2 \pm H_3.$$

It is impossible to have two negative signs on the right-hand side, but we may have one negative sign. So either $H_1 = H_2 + H_3$ or $H_1 + H_2 = H_3$. The two cases are equivalent after permuting indices, so let us suppose without loss of generality that $H_1 + H_2 = H_3$. Then, if we set all the cluster variables equal to 1 and all the coefficient variables equal to 0, we get $1 = 1 + 1$, which is a contradiction. □

PROPOSITION 6.4. Let γ be an essential loop in (S, M) . Then $\text{Brac}_k(\gamma)$ and $\text{Bang}_k(\gamma)$ have the same \mathbf{g} -vector.

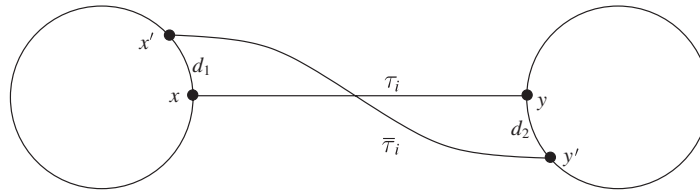

FIGURE 18. The arc $\bar{\tau}_i$.

Proof. On one hand, we have

$$\mathbf{g}(\text{Bang}_k \gamma) = \mathbf{g}(x_\gamma^k) = k\mathbf{g}(x_\gamma).$$

On the other hand, $\mathbf{g}(\text{Brac}_k(\gamma)) = \mathbf{g}(T_k(x_\gamma))$ by Proposition 4.2, and the result follows from Proposition 2.35. \square

Let e_i denote the element of \mathbb{Z}^n with a 1 in the i th place and zeros elsewhere. Let (τ_1, \dots, τ_n) denote the elements of the initial triangulation T . By the definition of \mathbf{g} -vectors, $\mathbf{g}(x_{\tau_i}) = e_i$ for all i . We now construct an element of \mathcal{A} whose \mathbf{g} -vector is $-e_i$, for each $1 \leq i \leq n$.

PROPOSITION 6.5. *Let i be an integer between 1 and n . Then there exists an arc $\bar{\tau}_i$ of (S, M) such that $\mathbf{g}(x_{\bar{\tau}_i}) = -e_i$. The arc $\bar{\tau}_i$ is constructed as follows. Suppose that τ_i is an arc between two marked points x and y , and let d_1 and d_2 denote the boundary segments such that d_1 is incident to x and is in the clockwise direction from τ_i , while d_2 is incident to y and is in the clockwise direction from τ_i . Let x' and y' be the other endpoints of d_1 and d_2 besides x and y . Let $\bar{\tau}_i$ be the arc of (S, M) between points x' and y' , which is homotopic to the concatenation of d_2, τ_i and d_1 . See Figure 18.*

Proof. Let r and s be the arcs in (S, M) from x to y' and from x' to y , respectively, obtained by resolving the crossing between $\bar{\tau}_i$ and τ_i . Then we have the exchange relation $x_{\tau_i} x_{\bar{\tau}_i} = Y x_r x_s + 1$, where Y is a monomial in the y_{τ_j} . Note that the term 1 comes from the two boundary segments obtained by resolving the crossing between $\bar{\tau}_i$ and τ_i in the other direction. Since cluster variables are homogeneous elements with respect to the \mathbf{g} -vector grading, it follows that $\mathbf{g}(x_{\tau_i} x_{\bar{\tau}_i}) = 0$. It then follows that $\mathbf{g}(x_{\bar{\tau}_i}) = -\mathbf{g}(x_{\tau_i}) = -e_i$, as desired. \square

Remark 6.6. In the corresponding cluster category, the arc $\bar{\tau}_i$ corresponds to the Auslander–Reiten translate of the arc τ_i ; see [BZ10].

6.1 Fans

Let T be a triangulation and let γ be an arc or a closed loop. Let Δ be a triangle in T with sides β_1, β_2 and τ that is crossed by γ in the following way: γ crosses β_1 at the point p_1 and crosses β_2 at the point p_2 , and the segment of γ from p_1 to p_2 lies entirely in Δ ; see the left diagram in Figure 19. Then there exist a unique vertex v of the triangle Δ and a unique contractible closed curve ϵ , given as the homotopy class of a curve starting at the point v , then following β_1 until the point p_1 , then following γ until the point p_2 , and then following β_2 until v . We will use the following notation to describe this definition:

$$\epsilon = v \xrightarrow{\beta_1} p_1 \xrightarrow{\gamma} p_2 \xrightarrow{\beta_2} v.$$

DEFINITION 6.7. A (T, γ) -fan with vertex v is a collection of arcs $\beta_0, \beta_1, \dots, \beta_k$, where $\beta_i \in T$ and $k \geq 0$, having the following properties (see the diagram on the right in Figure 19).

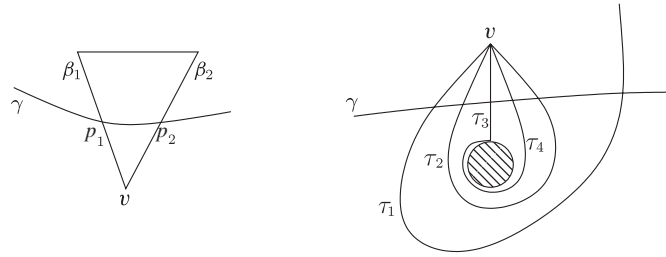

FIGURE 19. Left diagram: construction of (T, γ) -fans. Right diagram: the fan $\tau_1, \tau_2, \tau_3, \tau_4, \tau_2$ cannot be extended to the right, because the configuration $\tau_1, \tau_2, \tau_3, \tau_4, \tau_2, \tau_1$ does not satisfy condition (iii) of Definition 6.7.

- (i) γ crosses $\beta_0, \beta_1, \dots, \beta_k$ in order at the points p_0, p_1, \dots, p_k , such that p_i is a crossing point of γ and β_i and the segment of γ from p_0 to p_k does not have any other crossing points with T .
- (ii) Each β_i is incident to v .
- (iii) For each $i < k$, let ϵ_i be the unique contractible closed curve given by

$$v \xrightarrow{\beta_i} p_i \xrightarrow{\gamma} p_{i+1} \xrightarrow{\beta_{i+1}} v;$$

then, for each $i < k - 1$, the concatenation of the curves $\epsilon_i \epsilon_{i+1}$ is homotopic to

$$v \xrightarrow{\beta_i} p_i \xrightarrow{\gamma} p_{i+1} \xrightarrow{\gamma} p_{i+2} \xrightarrow{\beta_{i+2}} v.$$

Property (iii) in the above definition is equivalent to the condition that

$$v \xrightarrow{\beta_i} p_i \xrightarrow{\gamma} p_{i+2} \xrightarrow{\beta_{i+2}} v$$

is contractible.

DEFINITION 6.8. A (T, γ) -fan $\beta_0, \beta_1, \dots, \beta_k$ is said to be *maximal* if there is no arc $\alpha \in T$ such that $\beta_0, \beta_1, \dots, \beta_k, \alpha$ or $\alpha, \beta_0, \beta_1, \dots, \beta_k$ is a (T, γ) -fan.

Every (T, γ) -fan $\beta_0, \beta_1, \dots, \beta_k$ defines a triangle with simply connected interior whose vertices are v, p_0, p_k and whose boundary is the contractible curve

$$v \xrightarrow{\beta_0} p_0 \xrightarrow{\gamma} p_k \xrightarrow{\beta_k} v.$$

The orientation of the surface S induces an orientation on this triangle, and we say that β_0 is the *initial* arc and β_k is the *terminal* arc of the fan, if going around the boundary of the triangle along the curve $v \xrightarrow{\beta_0} p_0 \xrightarrow{\gamma} p_k \xrightarrow{\beta_k} v$ is in the clockwise direction. In the fan $\tau_1, \tau_2, \tau_3, \tau_2$ of the example given in the right-hand diagram of Figure 19, the initial arc is τ_2 and the terminal arc is τ_1 .

6.2 Multicurves and leading terms

Recall from § 4.2 that given any multicurve $\{\gamma_1, \dots, \gamma_t\}$, we can always apply a series of smoothings to replace it with a union of simple multicurves, called the *smooth resolution* of $\{\gamma_1, \dots, \gamma_t\}$. In the cluster algebra, taking the resolution of the multicurve $\{\gamma_1, \gamma_2, \dots, \gamma_t\}$

corresponds to applying skein relations to the product $x_{\gamma_1}x_{\gamma_2}\cdots x_{\gamma_t}$ until the result is a linear combination of elements of \mathcal{B}° . Also recall that, by Lemma 6.3, if we write the product $x_{\gamma_1}x_{\gamma_2}\cdots x_{\gamma_t}$ as a linear combination of elements of \mathcal{B}° , then there is a unique term with trivial coefficient, say $x_{\alpha_1}x_{\alpha_2}\cdots x_{\alpha_s}$, which is called the *leading term*. We say that the multicurve $\{\alpha_1, \alpha_2, \dots, \alpha_s\}$ is *equivalent to the leading term of the resolution of $\{\gamma_1, \gamma_2, \dots, \gamma_t\}$* . Note that any boundary segment b which appears during the process is not included in the multicurves, since the corresponding element x_b in the cluster algebra is equal to 1.

6.3 An inverse for the g-vector map

In this subsection, we use the (T, γ) -fans to prove that the **g**-vector map is a bijection between \mathcal{B}° and \mathbb{Z}^n . We will define a map $f : \mathbb{Z}^n \rightarrow \mathcal{B}^\circ$ and show that it is the inverse of the **g**-vector map. Recall that for an arc τ_i , we denote by $\bar{\tau}_i$ the unique arc whose **g**-vector is $-e_i$.

DEFINITION 6.9. Let $v = (v_1, \dots, v_n) \in \mathbb{Z}^n$, and write it uniquely as $v = \sum_i r_i e_i + \sum_j s_j (-e_j)$, where i ranges over all coordinates of v with $v_i > 0$ and j ranges over all coordinates of v with $v_j < 0$. So $r_i = v_i > 0$ and $s_j = -v_j > 0$. Then use the skein relations to write $\prod_i (x_{\tau_i})^{r_i} \prod_j (x_{\bar{\tau}_j})^{s_j}$ as a linear combination of elements in \mathcal{B}° . Define $f(v)$ to be the leading monomial in this sum, as defined by Lemma 6.3.

LEMMA 6.10. *The composition $\mathbf{g} \circ f$ is the identity map from \mathbb{Z}^n to itself, and so \mathbf{g} is surjective and f is injective.*

Proof. For $v \in \mathbb{Z}^n$, we have $\mathbf{g}(f(v)) = \mathbf{g}(\prod_i (x_{\tau_i})^{r_i} \prod_j (x_{\bar{\tau}_j})^{s_j})$; thus, by Definition 6.1, $\mathbf{g}(f(v)) = v$. \square

LEMMA 6.11. *Let γ be an arc. Choose an orientation of γ , and let s be its starting point and t its ending point. Denote by δ_s the arc that is clockwise from s in the first triangle of T that γ meets, and denote by δ_t the arc that is clockwise from t in the last triangle that γ meets. Let F_1, \dots, F_ℓ be the maximal (T, γ) -fans ordered by the orientation of γ , and let σ_i be the initial arc of F_i and τ_i the terminal arc of F_i .*

(i) *If γ crosses the initial arc of F_1 first, then γ is equivalent to the leading term in the resolution of the multicurve*

$$\{\delta_s, \delta_t, \bar{\sigma}_i, \tau_i, \bar{\sigma}_\ell \mid i \text{ is an odd integer with } 1 \leq i < \ell\}.$$

(ii) *If γ crosses the terminal arc of F_1 first, then γ is equivalent to the leading term in the resolution of the multicurve*

$$\{\delta_s, \delta_t, \bar{\sigma}_i, \tau_i, \bar{\sigma}_\ell \mid i \text{ is an even integer with } 2 \leq i < \ell\}.$$

Proof. We may assume without loss of generality that γ crosses the initial arc of F_1 first. Note first that $\sigma_i = \sigma_{i+1}$ for all even $i < \ell$ and that $\tau_i = \tau_{i+1}$ for all odd $i < \ell$. We proceed by induction on ℓ . Suppose first that $\ell = 1$. Then $\{\delta_s, \delta_t, \bar{\sigma}_1\}$ is the multicurve shown on the left of Figure 20, where boundary segments are labeled b .

The leading term of the resolution of this multicurve is shown on the right of Figure 20, and we see that it is equivalent to γ .

Now suppose that $\ell > 1$. The smoothing at the first crossing point p_1 of γ and σ_1 has the leading term $\{\delta_s, \gamma'\}$, where γ' is the arc starting at the vertex s' of the first fan F_1 , following σ_1 up to the point p_1 and then following γ until the endpoint t ; see Figure 21. Note that γ' is avoiding all the crossings with the fan F_1 . Thus the maximal (T, γ') -fans $F'_2, F'_3, \dots, F'_\ell$ are given

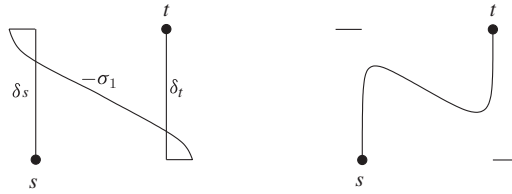

FIGURE 20. Proof of Lemma 6.11 for $\ell = 1$.

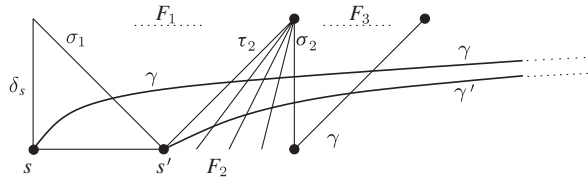

FIGURE 21. Proof of Lemma 6.11 for $\ell > 1$.

by $F'_i = F_i$, for $i > 2$, and F'_2 is obtained from F_2 by removing the terminal arc τ_2 . By induction, we know that γ' is equivalent to the leading term of the resolution of the multicurve

$$\{\tau_1 = \delta_{s'}, \delta_t, \bar{\sigma}_i, \tau_i, \bar{\sigma}_\ell \mid i \text{ is an odd integer with } 3 \leq i < \ell\}.$$

On the other hand, the leading term of the resolution of $\{\delta_s, \bar{\sigma}_1, \gamma'\}$ is equivalent to γ , and the result follows. \square

LEMMA 6.12. *Let γ be a closed loop. Let F_1, \dots, F_ℓ be the maximal (T, γ) -fans ordered by the orientation of γ , and let σ_i be the initial arc of F_i and τ_i the terminal arc of F_i . Then γ is equivalent to the leading term in the resolution of the multicurve*

$$\{\bar{\sigma}_i, \tau_i \mid i \text{ is an odd integer with } 1 \leq i \leq \ell - 1\},$$

which is the same as

$$\{\bar{\sigma}_i, \tau_i \mid i \text{ is an even integer with } 2 \leq i \leq \ell\}.$$

Proof. First, note that since γ is a closed loop, the number of maximal fans whose vertex lies in the interior of γ must be equal to the number of maximal fans whose vertex lies in the exterior of γ ; thus ℓ is even. Choose a starting point p and an orientation for γ such that the first arc that γ crosses is the terminal arc τ_1 of the fan F_1 in the point x , and then γ crosses the fan F_1 . Note that $\tau_\ell = \tau_1$, since γ is a closed loop. Upon smoothing the multicurve $\{\tau_\ell, \gamma\}$, we get a leading term γ' that is an arc starting at a point s , following τ_ℓ up to the point x , then following γ one time around up to the point x again, and then following τ_ℓ until its endpoint, which we label t .

Lemma 6.11 implies that γ' is equivalent to the leading term of the resolution of the multicurve

$$\{\delta_s, \delta_t, \bar{\sigma}_i, \tau_i, \bar{\sigma}_\ell \mid i \text{ is an even integer with } 2 \leq i < \ell\}.$$

Note that $\delta_s = \delta_t = \tau_\ell$. On the other hand, γ is equivalent to the leading term of the resolution of the multicurve $\{\gamma', (-\tau_\ell)\}$, and the result follows since the leading term of $\{(-\tau_\ell), \tau_\ell\}$ is equivalent to a union of boundary segments. \square

THEOREM 6.13. *The \mathbf{g} -vector maps $\mathbf{g} : \mathcal{B}^\circ \rightarrow \mathbb{Z}^n$ and $\mathbf{g} : \mathcal{B} \rightarrow \mathbb{Z}^n$ are both bijections.*

Proof. By Proposition 6.4, it suffices to show that $\mathbf{g} : \mathcal{B}^\circ \rightarrow \mathbb{Z}^n$ is a bijection. Lemmas 6.11 and 6.12 imply that each arc and each closed loop lies in the image of f , which allows us to conclude that f is surjective. We have shown in Lemma 6.10 that $\mathbf{g} \circ f$ is the identity on \mathbb{Z}^n , which shows that f is a bijection and $\mathbf{g} = f^{-1}$. \square

COROLLARY 6.14. *The sets \mathcal{B}° and \mathcal{B} are both linearly independent.*

Proof. Clearly, the extended $2n \times n$ exchange matrix \widetilde{B}_T associated to T , whose bottom $n \times n$ submatrix consists of the identity matrix, has linearly independent columns. Let x_1, \dots, x_n denote the cluster variables $x_{\tau_1}, \dots, x_{\tau_n}$, and let x_{n+1}, \dots, x_{2n} denote the coefficient variables $y_{\tau_1}, \dots, y_{\tau_n}$.

Proposition 6.2 implies that if γ is any arc, essential loop or bracelet, then x_γ has a unique term x_M which is a Laurent monomial in x_1, \dots, x_n and which is not divisible by any coefficient variable y_{τ_i} . Proposition 2.10 and Theorem 5.1 imply that the exponent vector of every other Laurent monomial in the expansion of x_γ can be obtained from the exponent vector of x_M by adding a non-negative linear combination of columns of \widetilde{B}_T . This means that x_M is the leading term of each Laurent expansion. Finally, Theorem 6.13 implies that the exponent vectors of the leading terms of all elements of \mathcal{B}° are pairwise distinct. Proposition 2.13 now implies that elements of \mathcal{B}° are linearly independent. The same proof works for \mathcal{B} . \square

For completeness, we include the following result on the computation of \mathbf{g} -vectors.

COROLLARY 6.15. (i) *The \mathbf{g} -vector of an arc is equal to $e_{\delta_s} + e_{\delta_t} - e_{\sigma_\ell} + \sum(e_{\tau_i} - e_{\sigma_i})$, where σ_i and τ_i are, respectively, the initial and terminal arcs of the i th fan, and the sum is taken over all maximal T -fans F_i of the arc, with odd (respectively, even) index i if the arc crosses an initial (respectively, terminal) arc first.*

(ii) *The \mathbf{g} -vector of a closed loop is equal to $\sum(e_{\tau_i} - e_{\sigma_i})$, where the sum is taken over all odd maximal T -fans of the loop, and σ_i and τ_i are, respectively, the initial and terminal arcs of the i th fan.*

Proof. This follows from Theorem 6.13 and Lemmas 6.11 and 6.12. \square

7. Coefficient systems coming from a full-rank exchange matrix

In this section we will prove Corollary 1.2, which extends the results of this paper to a cluster algebra from a surface with a coefficient system coming from a full-rank exchange matrix.

Let (S, M) be a surface without punctures and having at least two marked points, and let $T = (\tau_1, \dots, \tau_n)$ be a triangulation of (S, M) . Let B be a full-rank $m \times n$ exchange matrix whose top $n \times n$ part B_T comes from the triangulation T . Let $\mathcal{A}_* = \mathcal{A}(B) \subset \mathbb{Q}(x_1, \dots, x_m)$; here (x_1, \dots, x_n) is the set of initial cluster variables. We will construct two bases \mathbb{B}° and \mathbb{B} for \mathcal{A}_* using the corresponding bases \mathcal{B}° and \mathcal{B} for \mathcal{A} , where \mathcal{A} is the cluster algebra associated to (S, M) with principal coefficients with respect to the seed T .

In order to define \mathbb{B}° and \mathbb{B} , we need to recall the *separation formulas* from [FZ07]. We will apply them here to the case of the cluster algebra of geometric type, $\mathcal{A}_* = \mathcal{A}(B)$. First, we need some notation.

If $P(u_1, \dots, u_n)$ is a Laurent polynomial, we define $\text{Trop}(P)$ by setting

$$\text{Trop}\left(\prod_j u_j^{a_j} + \prod_j u_j^{b_j}\right) = \prod_j u_j^{\min(a_j, b_j)}$$

and extending linearly. In particular, $\text{Trop}(P)$ is always a Laurent monomial.

Let $\Sigma_{t_0} = (x_1, \dots, x_n; y_1, \dots, y_n; B_T)$ be the initial seed of the cluster algebra with principal coefficients \mathcal{A} . For each $1 \leq j \leq n$, we define

$$y_j = \prod_{i=n+1}^m x_i^{b_{ij}} \quad \text{and} \quad \hat{y}_j = \prod_{i=1}^m x_i^{b_{ij}}.$$

Then [FZ07, Theorem 3.7] and [FZ07, Corollary 6.3] express the cluster variable x_γ of \mathcal{A}_* in the following equivalent forms. Recall that X_γ^T and F_γ^T denote the quantities defined in Definitions 3.12 and 3.14; see also Remark 3.15.

PROPOSITION 7.1. *Let γ be an arc in (S, M) . Then the cluster variable x_γ of \mathcal{A}_* can be expressed as*

$$x_\gamma = \frac{X_\gamma^T(x_1, \dots, x_n; y_1, \dots, y_n)}{\text{Trop}(F_\gamma^T(y_1, \dots, y_n))} = \frac{F_\gamma^T(\hat{y}_1, \dots, \hat{y}_n)}{\text{Trop}(F_\gamma^T(y_1, \dots, y_n))} \cdot x_1^{g_1} \dots x_n^{g_n},$$

where (g_1, \dots, g_n) is the \mathbf{g} -vector of X_γ^T .

By analogy, if ζ is a closed loop in (S, M) , we define the cluster algebra element x_ζ in \mathcal{A}_* as follows.

DEFINITION 7.2. Let ζ be a closed loop in (S, M) . Then the cluster algebra element x_ζ in \mathcal{A}_* is defined to be

$$x_\zeta = \frac{X_\zeta^T(x_1, \dots, x_n; y_1, \dots, y_n)}{\text{Trop}(F_\zeta^T(y_1, \dots, y_n))} = \frac{F_\zeta^T(\hat{y}_1, \dots, \hat{y}_n)}{\text{Trop}(F_\zeta^T(y_1, \dots, y_n))} \cdot x_1^{g_1} \dots x_n^{g_n},$$

where (g_1, \dots, g_n) is the \mathbf{g} -vector of X_ζ^T (see Definition 6.1).

Note that it is easy to check that the second and third expressions above are equivalent, following the proof of [FZ07, Corollary 6.3].

Now that we have defined elements of \mathcal{A}_* associated to each arc and closed loop, we may define the collections of elements which will constitute our bases:

$$\mathbb{B}^\circ = \left\{ \prod_{c \in C} x_c \mid C \in \mathcal{C}^\circ(S, M) \right\} \quad \text{and} \quad \mathbb{B} = \left\{ \prod_{c \in C} x_c \mid C \in \mathcal{C}(S, M) \right\}.$$

As before, $\mathcal{C}^\circ(S, M)$ and $\mathcal{C}(S, M)$ denote the \mathcal{C}° -compatible and \mathcal{C} -compatible collections of arcs and loops.

THEOREM 7.3. \mathbb{B}° is a basis for \mathcal{A}_* and, similarly, \mathbb{B} is a basis for \mathcal{A}_* .

Proof. First, we show that \mathbb{B}° and \mathbb{B} are subsets of \mathcal{A}_* . We define a homomorphism of algebras $\phi: \mathcal{A} \rightarrow \mathcal{A}_*$ which sends each cluster variable X_γ^T to $X_\gamma^T(x_1, \dots, x_n; y_1, \dots, y_n)$. This is just a specialization of variables, so in particular it is a homomorphism. Using this notation,

$$x_\zeta = \frac{\phi(X_\zeta^T)}{\text{Trop}(F_\zeta^T(y_1, \dots, y_n))}, \tag{7.1}$$

where the denominator is a Laurent monomial in coefficient variables. Therefore, whenever X_ζ^T lies in \mathcal{A} , i.e. whenever X_ζ^T can be written as a polynomial in cluster variables, x_ζ can also be written as a polynomial in cluster variables and hence is in \mathcal{A}_* . Since we have shown that \mathcal{B}° and \mathcal{B} are subsets of \mathcal{A} , it follows that \mathbb{B}° and \mathbb{B} are subsets of \mathcal{A}_* .

Next, we show that \mathbb{B}° and \mathbb{B} are spanning sets for \mathcal{A}_* . As before, each k -bracelet $x_{\text{Brac}_k}(\zeta)$ can be written as a Chebyshev polynomial in x_ζ , so it suffices to show that \mathbb{B}° spans \mathcal{A}_* . By the arguments of the previous paragraph and (7.1), every skein relation in \mathcal{A} gives rise to a skein relation in \mathcal{A}_* . It follows that we can write every polynomial in cluster variables in terms of the elements of \mathbb{B}° .

Finally, we show that the elements of \mathbb{B}° (respectively, \mathbb{B}) are linearly independent. Every F -polynomial F_γ^T and F_ζ^T has constant term 1. Therefore it follows from Proposition 7.1 and Definition 7.2 that the Laurent expansion of any element x_γ (respectively, x_ζ) contains a Laurent monomial $x_1^{g_1} \dots x_n^{g_n} x_{n+1}^{g_{n+1}} \dots x_m^{g_m}$ where (g_1, \dots, g_n) is the \mathbf{g} -vector of x_γ (respectively, of x_ζ), and the exponent vector of any other Laurent monomial in the same expansion is obtained from (g_1, \dots, g_m) by adding some non-negative integer linear combination of the columns of B . The same property holds for monomials in the variables x_γ and x_ζ . Therefore, by Theorem 1.6 (which shows that the \mathbf{g} -vectors are all distinct) and Proposition 2.13, the elements of \mathbb{B}° are linearly independent. A similar argument holds for \mathbb{B} . □

ACKNOWLEDGEMENTS

We thank Grégoire Dupont, Sergey Fomin, Sasha Goncharov, Bernard Leclerc, Hugh Thomas, Dylan Thurston and Andrei Zelevinsky for interesting discussions. We are particularly grateful to Dylan Thurston for his inspiring lectures in Morelia, Mexico.

Appendix A. Extending the results to surfaces with punctures

In this appendix we explain how the results and proofs in this paper need to be modified when dealing with a marked surface (S, M) which has punctures, i.e. marked points in the interior of S . In the presence of punctures, cluster variables are in bijection with *tagged arcs*, which generalize ordinary arcs, and clusters are in bijection with *tagged triangulations*. In this appendix we will assume that the reader is familiar with tagged arcs; see [FST08, § 7] for details. If γ is an arc (without notches) with an endpoint at puncture p , we denote the corresponding tagged arc which is notched at p by $\gamma^{(p)}$. If γ is an arc (without notches) with endpoints at punctures p and q , we denote the corresponding tagged arc which is notched at both these punctures by $\gamma^{(pq)}$.

We believe that the results of the present paper may be extended to the case of marked surfaces (S, M) which have punctures. The main obstacle lies in proving the appropriate skein relations for tagged arcs, using principal coefficients, and extending Lemma 6.3 to this setting. We will present several approaches to doing so at the end of § A.4. We believe that the second approach described there is the most feasible; the drawback is that it involves giving separate proofs for all fifteen cases of the new tagged skein relations.

A.1 Definition of \mathcal{B}° and \mathcal{B}

Our definitions of the conjectural bases are just a slight generalization of the corresponding definitions from § 3.3.

DEFINITION A.1. A closed loop in (S, M) is said to be *essential* if it is not contractible *nor contractible onto a single puncture* and it does not have self-crossings.

DEFINITION A.2. A collection C of tagged arcs and essential loops is said to be \mathcal{C}° -compatible if the tagged arcs in C are pairwise compatible and no two elements of C cross each other. We define $\mathcal{C}^\circ(S, M)$ to be the set of all \mathcal{C}° -compatible collections in (S, M) .

A collection C of tagged arcs and bracelets is said to be \mathcal{C} -compatible if:

- the tagged arcs in C are pairwise compatible;
- no two elements of C cross each other except for the self-crossings of a bracelet; and
- given an essential loop γ in (S, M) , there is at most one $k \geq 1$ such that the k th bracelet $\text{Brac}_k \gamma$ lies in C , and, moreover, there is at most one copy of this bracelet $\text{Brac}_k \gamma$ in C .

We define $\mathcal{C}(S, M)$ to be the set of all \mathcal{C} -compatible collections in (S, M) .

DEFINITION A.3. We define \mathcal{B}° to be the set of all cluster algebra elements in $\mathcal{A} = \mathcal{A}_\bullet(B_T)$ corresponding to the set $\mathcal{C}^\circ(S, M)$, that is,

$$\mathcal{B}^\circ = \left\{ \prod_{c \in C} x_c \mid C \in \mathcal{C}^\circ(S, M) \right\}.$$

Similarly, we define

$$\mathcal{B} = \left\{ \prod_{c \in C} x_c \mid C \in \mathcal{C}(S, M) \right\}.$$

A.2 Cluster algebra elements associated to generalized tagged arcs

In order to prove that \mathcal{B}° and \mathcal{B} are spanning sets, we need to prove skein relations involving tagged arcs. As in the unpunctured case, the skein relation involving tagged arcs should have a simple pictorial description in terms of resolving a crossing. However, when one resolves two (tagged) arcs that cross each other more than once, one may get a generalized (tagged) arc, i.e. a (tagged) arc with a self-crossing; see Figure A.1. For this reason, we need to make sense of the element of the (fraction field of the) cluster algebra associated to a generalized tagged arc. As in [MSW11], in order to deduce the positivity of such elements with respect to all clusters, it suffices to consider cluster algebras of the form $\mathcal{A}_\bullet(B_T)$ where T is an *ideal triangulation* of (S, M) . (Note that the snake graph or band graph corresponding to an arc can be defined even if it crosses through self-folded triangles.)

There are several options for how to define the elements $x_{\gamma^{(p)}}$ and $x_{\gamma^{(pq)}}$ when $\gamma^{(p)}$ and $\gamma^{(pq)}$ are generalized tagged arcs. All three options should be equivalent.

(i) *Algebraic definition.* If γ is an arc (without self-crossings) with one end incident to a puncture p , then $x_\ell = x_\gamma x_{\gamma^{(p)}}$ where ℓ is the arc cutting out a once-punctured monogon enclosing p and γ . If γ is an arc (without self-crossings) between two punctures p and q , then there is a more complicated identity (see [MSW11, Theorem 12.9]) that expresses $x_{\gamma^{(pq)}}$ in terms of x_γ , $x_{\gamma^{(p)}}$ and $x_{\gamma^{(q)}}$. By analogy, if γ is a generalized arc (with self-crossings allowed), then one could define $x_{\gamma^{(p)}}$ and $x_{\gamma^{(pq)}}$ using the above algebraic identities.

(ii) *Combinatorial definition.* In [MSW11, Theorems 4.16 and 4.20], we proved that the cluster algebra elements associated to singly and doubly notched arcs $x_{\gamma^{(p)}}$ and $x_{\gamma^{(pq)}}$ have Laurent expansions which are given as sums over γ -symmetric matchings and γ -compatible pairs of matchings, respectively. By analogy, when γ is a generalized arc with self-intersections, one

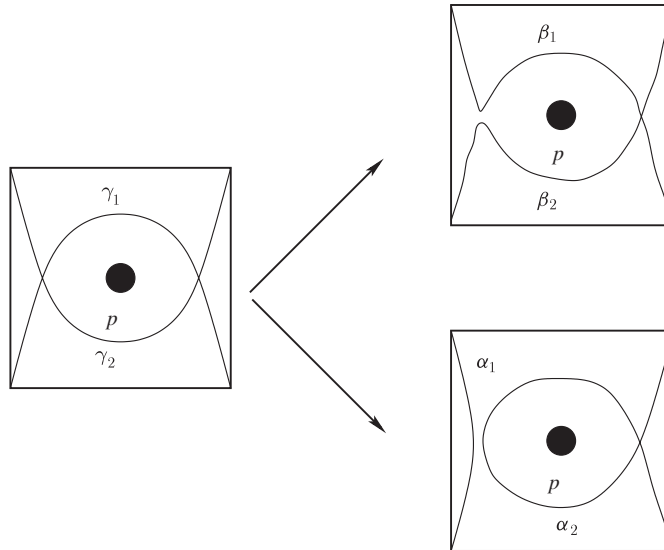

FIGURE A.1. Smoothing two arcs may produce a generalized arc with a self-crossing.

could define $x_{\gamma(p)}$ and $x_{\gamma(pq)}$ combinatorially, in terms of γ -symmetric matchings and γ -compatible pairs of matchings. The proofs of [MSW11, §12] should carry over and show that the above algebraic and combinatorial definitions of $x_{\gamma(p)}$ and $x_{\gamma(pq)}$ are equivalent.

(iii) *Definition using the separation formula.* The separation formula [FZ07, Theorem 3.7] expresses the cluster variables of a cluster algebra over an arbitrary semifield, with a seed at t_0 , using the cluster variables and F -polynomials of the corresponding cluster algebra with principal coefficients at t_0 . By using the separation formula together with the fact that the B -matrix of a tagged triangulation equals the B -matrix of a corresponding ideal triangulation (obtained by changing the tagging around a collection of punctures), one obtains a formula for cluster variables associated to ordinary arcs, in cluster algebras $\mathcal{A}_\bullet(B_T)$ where T is an arbitrary tagged triangulation. One can then combine this formula with [MSW11, Proposition 3.15] to obtain a formula for cluster variables associated to tagged arcs, in cluster algebras $\mathcal{A}_\bullet(B_T)$ where T is an arbitrary ideal triangulation. By analogy, when γ is a generalized arc, one could define $x_{\gamma(p)}$ and $x_{\gamma(pq)}$ by extending the above formula from tagged arcs to generalized tagged arcs.

A.3 Cluster algebra elements associated to closed loops

A closed loop is not incident to any marked points, so there is no such thing as a tagged closed loop. We therefore define $X_\zeta^T = x_\zeta$ when ζ is a closed curve via good matchings in a band graph, just as before (in Definition 3.14) but with one exception. If ζ is a closed loop without self-intersections enclosing a single puncture p , then $X_\zeta^T = 1 + y_\tau/y_\tau^{(p)}$ or $1 + \prod_{\tau \in T} y_\tau^{e_p(\tau)}$, depending on whether or not T contains a self-folded triangle enclosing p . Here, $e_p(\tau)$ denotes the number of ends of τ incident to p .

A.4 \mathcal{B}° and \mathcal{B} are spanning sets for \mathcal{A}

In order to prove that both \mathcal{B}° and \mathcal{B} span $\mathcal{A}_\bullet(S, M)$, one must prove skein relations involving tagged arcs. Note that two tagged arcs are incompatible if they cross each other or if they have an incompatible tagging at a puncture, as in the left-hand diagram of Figure A.2.

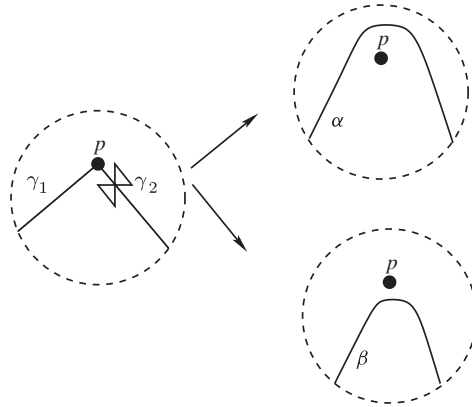

FIGURE A.2. Resolving an incompatibility at a puncture.

In particular, one must prove skein relations involving:

- (i) an ordinary arc and a singly notched arc which cross each other;
- (ii) an ordinary arc and a doubly notched arc which cross each other;
- (iii) two singly notched arcs which cross each other;
- (iv) a singly notched arc and a doubly notched arc which cross each other;
- (v) two doubly notched arcs which cross each other;
- (vi) an ordinary arc and a singly notched arc which have an incompatible tagging at a puncture;
- (vii) an ordinary arc and a doubly notched arc which have one incompatible tagging at a puncture;
- (viii) an ordinary arc and a doubly notched arc which have two incompatible taggings at a puncture;
- (ix) two singly notched arcs which have one incompatible tagging at a puncture;
- (x) two singly notched arcs which have two incompatible taggings at a puncture;
- (xi) a singly notched arc and a doubly notched arc which have an incompatible tagging at a puncture;
- (xii) a singly notched arc and a loop;
- (xiii) a doubly notched arc and a loop;
- (xiv) a singly notched generalized arc with a self-crossing;
- (xv) a doubly notched generalized arc with a self-crossing.

In the coefficient-free case, proving skein relations is straightforward. One can use the fact that given a puncture p in M , the map Ψ_p which sends an arc γ to either $\gamma^{(p)}$ or γ (depending on whether or not γ has an endpoint at p) induces an automorphism on the cluster algebra $\mathcal{A}(B_T) = \mathcal{A}(S, M)$. This automorphism maps the cluster corresponding to the triangulation T to the cluster corresponding to the triangulation T' obtained from T by changing the tags at the puncture p , and it is easy to show that it commutes with the mutations at these clusters; note that this is a cluster automorphism in the sense of [ASS12]. This reduces all of the tagged skein relations involving a crossing to the untagged skein relations that we have already proved.

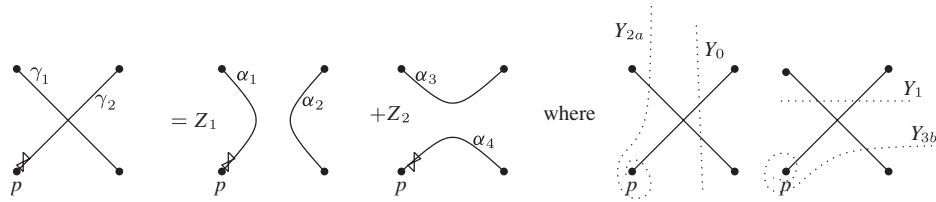

FIGURE A.3. Illustration of Example A.4.

Furthermore, it is straightforward to prove the skein relation from Figure A.2 involving an ordinary arc and a singly notched arc with an incompatible tagging at a puncture, by using the identity $x_\gamma x_{\gamma(p)} = x_\ell$ together with an ordinary skein relation (and the same proof works with principal coefficients as well). Similar proofs should work for all other skein relations involving an incompatible tagging at a puncture, at least in the coefficient-free case. Note that Fock and Goncharov proved (see [FG06, § 12.6]) that \mathcal{B} is a basis of the upper cluster algebra in the coefficient-free case, even in the presence of punctures, by utilizing the monodromy around punctures.

However, in the presence of principal coefficients, the map Ψ_p is not a cluster automorphism on $\mathcal{A}_\bullet(B_T)$; it acts non-trivially on the coefficients. Therefore it is not possible, as above, to use this map to reduce the tagged skein relations involving a crossing to the corresponding untagged skein relations.

Additionally, we do not know a good analogue of the matrix formulas in [MW11] for cluster variables associated to arcs with notches. If one had such matrix formulas, one might hope to prove the corresponding skein relations via matrix identities, as in [MW11].

There are several alternative approaches that one might use. A first approach is to use the formulas and definitions of § A.2(iii) (the separation formula) to prove the tagged skein relations. This approach allows us to express the cluster algebra elements associated to tagged arcs and tagged generalized arcs in terms of the cluster variables and F -polynomials associated to untagged arcs and generalized arcs. From such formulas, one could obtain some ‘skein relations’ immediately. However, using this approach, it is not at all clear how to prove the analogue of Lemma 6.3.

A second approach is to use the algebraic identities that the cluster algebra elements associated to tagged arcs satisfy. For example, if one wants to prove the skein relation involving an ordinary arc x_{γ_1} and a singly notched arc $x_{\gamma_2(p)}$ which cross each other, one could use the identity $x_{\gamma_2} x_{\gamma_2(p)} = x_{\ell_0}$. By considering the skein relation involving x_{γ_1} and x_{ℓ_0} , and keeping careful track of the coefficients using the lamination corresponding to the initial triangulation T , it is possible to write down the skein relation that expresses $x_{\gamma_1} x_{\gamma_2(p)}$.

Example A.4 (Case (i) of the skein relations). Let $\alpha_1, \alpha_2, \alpha_3$ and α_4 be the four arcs obtained by smoothing at the intersection point of γ_1 and γ_2 , as shown in Figure A.3. Then there are monomials in the coefficient variables Z_1 and Z_2 such that

$$x_{\gamma_1} x_{\gamma_2(p)} = Z_1 x_{\alpha_1} x_{\alpha_2} + Z_2 x_{\alpha_3} x_{\alpha_4}, \tag{A.1}$$

and precisely one of them equals 1.

Proof. To show this, we will show that $Z_1 = Y_0 Y_{2a}$ and $Z_2 = Y_1 Y_{3b}$, where Y_0, Y_1, Y_{2a} and Y_{3b} are monomials in coefficient variables representing contributions from the laminations whose local

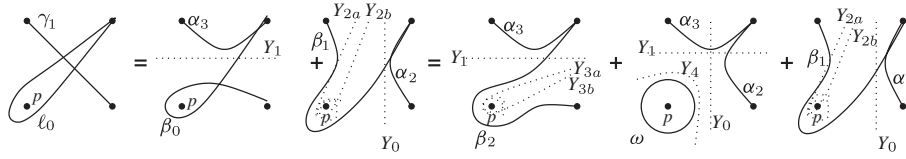

FIGURE A.4. Left-hand side of (A.1).

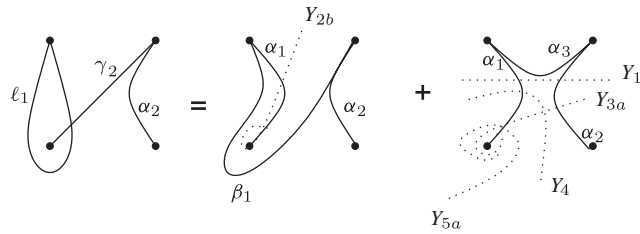

FIGURE A.5. First term on the right-hand side of (A.1).

configurations are as shown by the dotted curves in Figure A.3. Note that we use the subscript ‘a’ (respectively, ‘b’) to indicate a contribution from laminations spiraling counterclockwise (respectively, clockwise) into the puncture.

We multiply both sides of (A.1) by x_{γ_2} and verify the resulting equation. Applying skein relations to x_{γ_2} times the left-hand-side of (A.1), i.e. to $x_{\gamma_2}x_{\gamma_1}x_{\gamma_2(p)} = x_{\gamma_1}x_{\ell_0}$, we get

$$x_{\gamma_1}x_{\ell_0} = Y_1x_{\alpha_3}x_{\beta_0} + Y_{2a}Y_{2b}Y_0x_{\beta_1}x_{\alpha_2} \tag{A.2}$$

$$= Y_1Y_{3a}Y_{3b}x_{\alpha_3}x_{\beta_2} + Y_0Y_1Y_4x_{\alpha_2}x_{\alpha_3}x_{\omega} + Y_0Y_{2a}Y_{2b}x_{\alpha_2}x_{\beta_1}, \tag{A.3}$$

where the (generalized) arcs β_0, β_1 and β_2 and the closed loop ω are as in Figure A.4. Also, $Y_{2a}, Y_{2b}, Y_{3a}, Y_{3b}$ and Y_4 are monomials in coefficient variables representing contributions from laminations whose local configurations are as shown by the dotted curves in Figure A.4.

On the right-hand side of (A.1), after multiplying through by x_{γ_2} we obtain

$$\begin{aligned} x_{\gamma_2}x_{\alpha_1(p)}x_{\alpha_2} &= x_{\ell_1}x_{\beta}x_{\alpha_2}(x_{\alpha_1})^{-1} \\ &= (Y_{2b}x_{\alpha_1}x_{\alpha_2}x_{\beta_1} + Y_1Y_{3a}Y_4Y_{5a}x_{\alpha_1}x_{\alpha_2}x_{\alpha_3})(x_{\alpha_1})^{-1} \\ &= Y_{2b}x_{\alpha_2}x_{\beta_1} + Y_1Y_4Y_{3a}Y_{5a}x_{\alpha_2}x_{\alpha_3}; \end{aligned}$$

see Figure A.5. Here Y_{5a} represents the contribution from all leaves spiraling counterclockwise into p which are not already included in Y_{2a} or Y_{3a} .

Similarly, using the notation of Figure A.6, we get

$$x_{\gamma_2}x_{\alpha_3}x_{\alpha_4(p)} = x_{\gamma_2}x_{\alpha_3}x_{\ell_2}(x_{\alpha_4})^{-1} = Y_{3a}x_{\alpha_3}x_{\beta_2} + Y_0Y_4Y_{2b}Y_{5b}x_{\alpha_3}x_{\alpha_2}.$$

Therefore, x_{γ_2} times the right-hand-side of (A.1) is equal to

$$Z_1Y_{2b}x_{\beta_1}x_{\alpha_2} + Z_2Y_{3a}x_{\alpha_3}x_{\beta_2} + (Z_1Y_1Y_4Y_{3a}Y_{5a} + Z_2Y_0Y_4Y_{2b}Y_{5b})x_{\alpha_2}x_{\alpha_3}. \tag{A.4}$$

We need to show that the expressions (A.4) and (A.3) are equivalent.

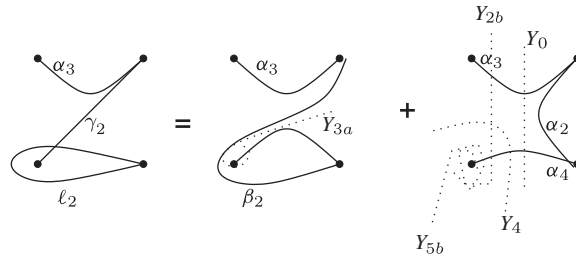

FIGURE A.6. Second term on the right-hand side of (A.1).

Setting $Z_1 = Y_0Y_{2a}$ and $Z_2 = Y_1Y_{3b}$ makes two terms in each of the above expressions coincide, so we have reduced the proof of (A.1) to showing that $Y_0Y_{2a}Y_1Y_4Y_{3a}Y_{5a} + Y_1Y_{3b}Y_0Y_4Y_{2b}Y_{5b} = Y_0Y_1Y_4x_\omega$ or, equivalently,

$$Y_{2a}Y_{3a}Y_{5a} + Y_{3b}Y_{2b}Y_{5b} = x_\omega. \tag{A.5}$$

There are two cases, based on whether or not T contains a self-folded triangle enclosing the puncture p . If not, then all leaves of the lamination spiral counterclockwise into p , and so $Y_{2b}Y_{3b}Y_{5b} = 1$. In this case, it follows from the definition that $x_\omega = 1 + Y_{2b}Y_{3b}Y_{5b}$ (since the second monomial represents the product of all coefficient variables indexed by arcs of T incident to p). This proves (A.5).

If T does contain a self-folded triangle enclosing the puncture p , then let us denote the radius incident to p by r . In this case, there are exactly two leaves of the lamination spiraling into p , L_r and L_{r^p} , which spiral counterclockwise and clockwise, respectively. The left-hand-side of (A.5) then equals $y_r + y_{r^p}$. But this agrees with the definition of x_ω . Either way, we have now shown (A.1).

Now, we claim that at least one of Y_0 and Y_1 is not equal to 1. If both were 1, then any laminations cutting across the quadrilateral formed by the endpoints of γ_1 and γ_2 would have to cut across corners of the quadrilateral. But such a lamination could not have come from a triangle. Now note that if $Y_1 \neq 1$, then Y_0 and Y_{2a} must equal 1, since the leaves of a lamination cannot intersect each other. Similarly, if $Y_0 \neq 1$, then Y_1 and Y_{3b} must equal 1. \square

We have shown how to prove the first of fifteen skein relations, as well as how to prove the analogue of Lemma 6.3 for this case. In theory, one could use a similar argument on a case-by-case basis for the remaining fourteen types of skein relations above. *We believe that this approach would successfully generalize the results of the present paper to the case of general surfaces (S, M) , with or without punctures.*

A.5 \mathcal{B}° and \mathcal{B} are linearly independent sets

If one could extend Lemma 6.3 to the case of tagged arcs, then it would be possible to prove that the sets \mathcal{B}° and \mathcal{B} are linearly independent.

Indeed, one can extend Proposition 6.5 to define a tagged arc $\bar{\tau}_i$ of (S, M) such that $\mathbf{g}(x_{\bar{\tau}_i}) = -e_i$ for each $1 \leq i \leq n$. This could be called the *anti-arc* construction.

- If τ_i is an arc between two marked points which are both on a boundary component, then the definition of $\bar{\tau}_i$ is the same as in Proposition 6.5.
- Suppose that τ_i is an arc between two marked points x and p , where x lies on a boundary

component and p is a puncture. Let d_1 denote the boundary segment such that d_1 is incident to x and is in the clockwise direction from τ_i ; let x' denote the other endpoint of d_1 . Let $\bar{\tau}_i$ be the tagged arc of (S, M) between the points x' and p , tagged plain at x' and notched at p , such that its untagged version is homotopic to the concatenation of d_1 and τ_i .

- Suppose that τ_i is an arc between two punctures p and q . Let $\bar{\tau}_i$ be the tagged arc of (S, M) which is obtained from τ_i by notching both ends.

In order to prove that $\mathbf{g}(x_{\bar{\tau}_i}) = -e_i$, one uses the tagged skein relations.

It is then straightforward to extend the arguments of § 6.3 to show that in almost all cases, the \mathbf{g} -vector maps $\mathbf{g} : \mathcal{B}^\circ \rightarrow \mathbb{Z}^n$ and $\mathbf{g} : \mathcal{B} \rightarrow \mathbb{Z}^n$ are bijections. A main tool here is the generalization of Lemma 6.3. The only situation in which the \mathbf{g} -vector map is not a bijection to \mathbb{Z}^n is the case where (S, M) is a once-punctured closed surface. In this case, \mathbf{g} is an injection but not a surjection. (This is because the anti-arc construction for such a surface always gives a doubly tagged arc which is in the tagged arc complex but not the cluster complex, when (S, M) is a once-punctured closed surface.) However, injectivity suffices to show linear independence: by the proof of Corollary 6.14, it is enough to know that the \mathbf{g} -vectors of the basis elements are all distinct.

A.6 \mathcal{B}° and \mathcal{B} are subsets of \mathcal{A}

One can show that the bases \mathcal{B}° and \mathcal{B} are subsets of \mathcal{A}_\bullet if S has a non-empty boundary and at least two of its marked points are on the boundary, or if S has genus zero. It suffices to show that the cluster algebra elements corresponding to essential loops lie in \mathcal{A}_\bullet .

The proof of Proposition 4.5 (which treats the case where at least two marked points are on the boundary) goes through without changes in the presence of punctures.

However, when (S, M) has punctures, a new argument is required in order to prove Corollary 4.6 (which treats the case where S has genus zero). Let ζ be an essential loop that cuts out a disk with at least two punctures m_1 and m_2 inside it. If S is a sphere, then ζ cuts out two disks, and we choose the one with the smaller number of punctures inside it. One can then prove Corollary 4.6 by induction on the number of punctures inside ζ . The idea is to consider an appropriate skein relation involving an unnotched arc between m_1 and m_2 and a doubly notched arc between m_1 and m_2 .

REFERENCES

- Ami09 C. Amiot, *Cluster categories for algebras of global dimension 2 and quivers with potential*, Ann. Inst. Fourier **59** (2009), 2525–2590.
- ABCP10 I. Assem, T. Brüstle, G. Charbonneau-Jodoin and P. G. Plamondon, *Gentle algebras arising from surface triangulations*, Algebra Number Theory **4** (2010), 201–229.
- ASS12 I. Assem, R. Schiffler and V. Shramchenko, *Cluster automorphisms*, Proc. Lond. Math. Soc. **104** (2012), 1271–1302.
- BZ10 T. Brüstle and J. Zhang, *On the cluster category of a marked surface*, Algebra Number Theory, to appear, arXiv:1005.2422.
- BMRRT06 A. Buan, R. Marsh, M. Reineke, I. Reiten and G. Todorov, *Tilting theory and cluster combinatorics*, Adv. Math. **204** (2006), 572–612.
- CCS06 P. Caldero, F. Chapoton and R. Schiffler, *Quivers with relations arising from clusters (A_n case)*, Trans. Amer. Math. Soc. **358** (2006), 1347–1364.

- CK08 P. Caldero and B. Keller, *From triangulated categories to cluster algebras*, *Invent. Math.* **172** (2008), 169–211.
- Cer09 G. Cerulli Irelli, *Cluster algebras of type $A_2^{(1)}$* , *Algebr. Represent. Theory*, to appear, arXiv:0904.2543.
- Cer11 G. Cerulli Irelli, *Positivity in skew-symmetric cluster algebras of finite type*, Preprint (2011), arXiv:1102.3050.
- CL12 G. Cerulli Irelli and D. Labardini-Fragoso, *Quivers with potentials associated to triangulated surfaces, Part III: tagged triangulations and cluster monomials*, *Compositio Math.* **148** (2012), 1833–1866.
- CKLP12 G. Cerulli Irelli, B. Keller, D. Labardini-Fragoso and P.-G. Plamondon, *Linear independence of cluster monomials for skew-symmetric cluster algebras*, Preprint (2012), arXiv:1203.1307.
- CL90 J. Conway and J. Lagarias, *Tiling with polyominoes and combinatorial group theory*, *J. Combin. Theory Ser. A* **53** (1990), 183–208.
- DWZ10 H. Derksen, J. Weyman and A. Zelevinsky, *Quivers with potentials and their representations II: Applications to cluster algebras*, *J. Amer. Math. Soc.* **23** (2010), 749–790.
- DXX09 M. Ding, J. Xiao and F. Xu, *Integral bases of cluster algebras and representations of tame quivers*, Preprint (2009), arXiv:0901.1937.
- Dup08 G. Dupont, *Generic variables in acyclic cluster algebras and bases in affine cluster algebras*, Preprint (2008), arXiv:0811.2909.
- Dup10 G. Dupont, *Transverse quiver Grassmannians and bases in affine cluster algebras*, *Algebra Number Theory* **4** (2010), 599–624.
- Dup11 G. Dupont, *Generic variables in acyclic cluster algebras*, *J. Pure Appl. Algebra* **215** (2011), 628–641.
- DT11 G. Dupont and H. Thomas, *Atomic bases in cluster algebras of types A and \tilde{A}* , Preprint, (2011), arXiv:1106.3758.
- EKLP92 N. Elkies, G. Kuperberg, M. Larsen and J. Propp, *Alternating-sign matrices and domino tilings I*, *J. Algebraic Combin.* **1** (1992), 111–132.
- FST12 A. Felikson, M. Shapiro and P. Tumarkin, *Skew-symmetric cluster algebras of finite mutation type*, *J. Eur. Math. Soc.* **14** (2012), 1135–1180.
- FG06 V. Fock and A. Goncharov, *Moduli spaces of local systems and higher Teichmüller theory*, *Publ. Math. Inst. Hautes Études Sci.* **103** (2006), 1–211.
- FG07 V. Fock and A. Goncharov, *Dual Teichmüller and lamination spaces*, in *Handbook of Teichmüller theory. Volume I*, IRMA Lectures in Mathematics and Theoretical Physics, vol. 11 (European Mathematical Society, Zürich, 2007), 647–684.
- FG09 V. Fock and A. Goncharov, *Cluster ensembles, quantization and the dilogarithm*, *Ann. Sci. Éc. Norm. Supér. (4)* **42** (2009), 865–930.
- FST08 S. Fomin, M. Shapiro and D. Thurston, *Cluster algebras and triangulated surfaces. Part I: cluster complexes*, *Acta Math.* **201** (2008), 83–146.
- FT08 S. Fomin and D. Thurston, *Cluster algebras and triangulated surfaces. Part II: lambda lengths*, Preprint (2008), <http://www.math.lsa.umich.edu/~fomin/Papers/cats2.ps>.
- FZ02 S. Fomin and A. Zelevinsky, *Cluster algebras I: foundations*, *J. Amer. Math. Soc.* **15** (2002), 497–529.
- FZ07 S. Fomin and A. Zelevinsky, *Cluster algebras IV: coefficients*, *Compositio Math.* **143** (2007), 112–164.
- FG00 C. Frohman and R. Gelca, *Skein modules and the noncommutative torus*, *Trans. Amer. Math. Soc.* **352** (2000), 4877–4888.
- GLS11a C. Geiss, B. Leclerc and J. Schröer, *Kac–Moody groups and cluster algebras*, *Adv. Math.* **228** (2011), 329–433.

- GLS11b C. Geiss, B. Leclerc and J. Schröer, *Cluster structures on quantum coordinate rings*, *Selecta Math.*, to appear, arXiv:1104.0531.
- GLS12 C. Geiss, B. Leclerc and J. Schröer, *Generic bases for cluster algebras and the Chamber Ansatz*, *J. Amer. Math. Soc.* **25** (2012), 21–76.
- GSV05 M. Gekhtman, M. Shapiro and A. Vainshtein, *Cluster algebras and Weil–Petersson forms*, *Duke Math. J.* **127** (2005), 291–311.
- GSV10 M. Gekhtman, M. Shapiro and A. Vainshtein, *Cluster algebras and Poisson geometry*, *Mathematical Surveys and Monographs*, vol. 167 (American Mathematical Society, Providence, RI, 2010).
- HL11 D. Hernandez and B. Leclerc, *Quantum Grothendieck rings and derived Hall algebras*, Preprint (2011), arXiv:1109.0862.
- Lab09 D. Labardini-Fragoso, *Quivers with potentials associated to triangulated surfaces*, *Proc. Lond. Math. Soc.* (3) **98** (2009), 797–839.
- Lam11a P. Lampe, *A quantum cluster algebra of Kronecker type and the dual canonical basis*, *Int. Math. Res. Not.* **2011** (2011), 2970–3005.
- Lam11b P. Lampe, *Quantum cluster algebras of type A and the dual canonical basis*, Preprint (2011), arXiv:1101.0580.
- Lus90 Lusztig, *Canonical bases arising from quantized enveloping algebras*, *J. Amer. Math. Soc.* **3** (1990), 447–498.
- Lus93 Lusztig, *Introduction to quantum groups*, *Progress in Mathematics*, vol. 110 (Birkhäuser, Basel, 1993).
- Lus94 Lusztig, *Total positivity in reductive groups*, in *Lie theory and geometry: in honor of Bertram Kostant*, *Progress in Mathematics*, vol. 123 (Birkhäuser, Basel, 1994).
- MS10 G. Musiker and R. Schiffler, *Cluster expansion formulas and perfect matchings*, *J. Algebraic Combin.* **32** (2010), 187–209.
- MSW11 G. Musiker, R. Schiffler and L. Williams, *Positivity for cluster algebras from surfaces*, *Adv. Math.* **227** (2011), 2241–2308.
- MW11 G. Musiker and L. Williams, *Matrix formulae and skein relations for cluster algebras from surfaces*, *Int. Math. Res. Not.*, to appear, arXiv:1108.3382.
- Pen87 R. Penner, *The decorated Teichmüller space of punctured surfaces*, *Comm. Math. Phys.* **113** (1987), 299–339.
- Pen06 R. Penner, *Lambda lengths*, Preprint (2006), <http://www.ctqm.au.dk/research/MCS/lambdaLengths.pdf>.
- Pla11a P. G. Plamondon, *Catégories amassées aux espaces de morphismes de dimension infinie, applications*, PhD thesis, Université Paris Diderot (2011). <http://people.math.jussieu.fr/~plamondon/plamondonthese.pdf>.
- Pla11b P. G. Plamondon, *Cluster algebras via cluster categories with infinite-dimensional morphism spaces*, *Compositio Math.* **147** (2011), 1921–1934.
- Pro02 J. Propp, *Lattice structure for orientations of graphs*, Preprint (2002), arXiv:math/0209005.
- Sch08 R. Schiffler, *A geometric model for cluster categories of type D_n* , *J. Algebraic Combin.* **27** (2008), 1–21.
- Sch08 R. Schiffler, *A cluster expansion formula (A_n case)*, *Electron. J. Combin.* **15** (2008), #R64.
- Sch10 R. Schiffler, *On cluster algebras arising from unpunctured surfaces II*, *Adv. Math.* **223** (2010), 1885–1923.
- ST09 R. Schiffler and H. Thomas, *On cluster algebras arising from unpunctured surfaces*, *Int. Math. Res. Not.* **2009** (2009), 3160–3189.
- SZ04 P. Sherman and A. Zelevinsky, *Positivity and canonical bases in rank 2 cluster algebras of finite and affine types*, *Mosc. Math. J.* **4** (2004), 947–974, 982.

BASES FOR CLUSTER ALGEBRAS FROM SURFACES

- Thu D. Thurston, Geometric intersection of curves in surfaces, Preprint,
<http://www.math.columbia.edu/~dpt/DehnCoordinates.ps>.
- Thu88 W. Thurston, *On the geometry and dynamics of diffeomorphisms of surfaces*, Bull. Amer. Math. Soc. (N.S.) **19** (1988), 417–431.
- Thu90 W. Thurston, *Conway's tiling groups*, Amer. Math. Monthly **97** (1990), 757–773.
- Thu08 D. Thurston, *Lectures at the International Conference on Cluster Algebras and Related Topics, Mexico, December 8–20, 2008*, based on joint work with Sergey Fomin and Michael Shapiro.
- Zel07 A. Zelevinsky, *Semicanonical basis generators of the cluster algebra of type $A_1^{(1)}$* , Electron. J. Combin. **14** (2007), #N4.

Gregg Musiker musiker@math.umn.edu

School of Mathematics, University of Minnesota, Minneapolis, MN 55455, USA

Ralf Schiffler schiffler@math.uconn.edu

Department of Mathematics, University of Connecticut, Storrs, CT 06269, USA

Lauren Williams williams@math.berkeley.edu

Department of Mathematics, University of California, Berkeley, CA 94720, USA