

THE STRUCTURES OF ORNITHINE-VERMICULITE AND 6-AMINOHEXANOIC ACID-VERMICULITE

P. G. SLADE, M. I. TELLERIA and E. W. RADOSLOVICH

(Received 22 January 1976)

Abstract—Fourier syntheses have been used to establish the arrangement of organic molecules in the interlamellar regions of a 16.10 Å phase of ornithine-vermiculite and a 16.92 Å phase of 6-aminohexanoic acid-vermiculite. The organic cations form two layers parallel to the silicate surfaces in ornithine-vermiculite and in 6-aminohexanoic acid-vermiculite the organic cations form ascending and descending “stairs” from the silicate sheets.

Ornithine-vermiculite forms a true single layer polytype but by contrast 6-aminohexanoic acid-vermiculite is two-layered and has a true *c* axis of 34.09 Å. Since a two layered vermiculite was used as a starting material to prepare the organic complexes, exchangeable organic cations affect the stacking sequence of the silicate sheets.

INTRODUCTION

An interlamellar complex formed by lysine and vermiculite has been described previously (Raupach *et al.*, 1975). The present study contrasts the complex formed between ornithine and vermiculite with that formed between 6-aminohexanoic acid and vermiculite.

Mifsud *et al.* (1970) described the formation of cationic complexes of vermiculite-ornithine-water with basal spacings from 42.2 to 14.35 Å. Rausell-Colom and Fornés (1974) made one-dimensional Fourier analyses of three stable crystalline phases (with basal spacings of 20.3 Å, 16.3 Å, 16.3 Å and 14.63 Å). They deduced that the 16.3 Å phases contained mono-valent ornithine cations and water molecules. The 14.63 Å phase was dehydrated and, as shown by i.r. spectroscopy, contained amino-acid molecules linked through peptide bonds.

Kanamaru and Vand (1970) showed by two-dimensional X-ray analysis of a 6-aminohexanoic acid-vermiculite complex, formed at pH 5.5, that the organic molecules were statistically distributed over crystallographically equivalent sites with the carbon chains parallel to the *b*-axis of the vermiculite. As a pH of 5.5 is intermediate between the isoelectric point (pH 7.6) and that for the cationic-form (pH 3.2) of 6-aminohexanoic acid, we have investigated the complex formed between vermiculite and 6-aminohexanoic acid at the pH 3.2.

In a structural study of a vermiculite-piperidine complex, Iglesias and Steinfink (1974) concluded that their data led only to ambiguous models for the orientation of the organic molecules and remarked “It appears that on the basis of four complexes studied by us, by single crystal X-ray diffraction techniques and from results reported by other investigators, that the statistical distribution of organic molecules is inherent in the nature of these complexes and that probably no crystallographically ordered complexes can be prepared by the usual ion exchange

techniques.” We have also found that X-ray Fourier analysis does not yield a complete definition of the structural parameters for organic-vermiculites, but in conjunction with i.r. studies we have been able to distinguish explicitly between the arrangement of ornithine molecules which lie parallel to the surface oxygen atoms of the silicate layers and a stair-type arrangement of 6-aminohexanoic acid molecules which form ‘stairs’ away from it.

The present paper describes an X-ray study of the complex (formed at pH 3.2) between 6-aminohexanoic acid and vermiculite. We also refer to a parallel i.r. study in this laboratory by Raupach and Janik (1975) of the same vermiculite-organic complexes. The results are compared with those obtained by Rausell-Colom and Fornés (1974) using the same methods upon an apparently identical phase of ornithine-vermiculite. We show that our 16.22 Å phase of ornithine-vermiculite is a true single-layer polytype, although the original vermiculite is two-layered. By contrast, our 6-aminohexanoic acid-vermiculite is a two-layer polytype. Thus the exchangeable organic cations affect the stacking sequence of the silicate sheets. This complements the study of Calle *et al.* (1975) on Mg, Ca, Na and Ba vermiculites where shifts between adjacent silicate layers were reported to occur according to the polarizing power of the exchangeable cation.

EXPERIMENTAL

Sample preparation

The vermiculite used came from Kapirikamodzi and was obtained from Dr. K. Norrish who previously analysed a calcium saturated sample and calculated its formula as:

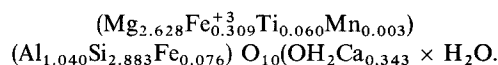

Its cation exchange capacity is 174 m-equiv./100 g

(ignited basis) which is equivalent to 1.37 charge units/24 oxygens. The *l*-ornithine monohydrochloride (chromatographically homogenous) was a BDH biochemical with a calculated molecular weight of 168.63. The 6-aminohexanoic acid (an Eastman chemical) had a molecular weight of 131.18.

The natural vermiculite was cut into flakes about $0.5 \times 0.3 \times 0.1$ mm and treated with a 1 N solution of sodium chloride for 48 hr at 80°C. Flakes were then lightly washed with distilled water and reacted with 0.5 N solutions either of *l*-ornithine monohydrochloride or 6-aminohexanoic acid at the pH of maximum cation concentration, 5.2 or 3.2 respectively. Reactions were followed with a transmitted light microscope by observing the replacement boundaries as they moved from the edges of flakes to their centres. Specimens were then left in the amino acid solution for a further two hours at 40°C; after this they were washed, to remove excess organic material and dried at room temperature. The rate of reaction between vermiculite and 6-aminohexanoic acid was considerably slower than that between vermiculite and ornithine. After drying at room temperature, the basal spacing of the 6-aminohexanoic acid-vermiculite was found to be 16.92 Å and the ornithine-vermiculite had formed a phase with a basal spacing of 19.69 Å. This value is to be contrasted with Rausell-Colom and Fornés (1974) result of 20.3 Å. Upon heating the ornithine-vermiculite for 12 hr at 60°C, or by leaving the material at room temperature for four days, we obtained the 16.1 Å phase from the material with a d_{001} of 19.69 Å. Samples of each complex checked a number of times over a period of three months were found to have both constant *d*-spacings and reflection patterns.

METHODS

To obtain the 00*l* spectra, single crystals were mounted on Mylar films stretched over specimen holders of the type normally used for powders. Filtered cobalt radiation was used in a Norelco powder diffractometer with the following slits: divergence 0.25°, receiving 0.146 mm in front of a 1° slit. The scan rate was 1°/min.

Reacted flakes of each complex were mounted upon glass fibres and oscillation photographs were taken with filtered CoK α radiation, flakes which gave the nearest approximation to sharp single crystal patterns were chosen for structural work.

The pseudo-hexagonal character of layer silicate crystals makes the choice of unique *a* or *b* axes difficult. This problem was resolved in our work by taking Weissenberg photographs about each of the three *a* axes. Only one such photograph showed *Ok**l* and *Ok**l* reflections equal in intensity and arranged symmetrically about *b**. This unique direction was taken as the true *b** for the crystal. From Weissenberg photographs, carefully checked against accurate computer-drawn templates and from diffractometer traces

of the 00*l* spectra, dimensions of the monoclinic cells of the ornithine and the 6-aminohexanoic acid vermiculites were determined to be $a = 5.33$ Å, $b = 9.18$ Å, $c = 16.22$ Å, $\beta = 97.0^\circ$; $a = 5.33$ Å, $b = 9.18$ Å, $c = 34.09$ Å and $\beta = 97.0^\circ$ respectively. These cell dimensions describe a one-layer polymorph for the ornithine complex and a two-layer polymorph for the 6-aminohexanoic acid complex.

The only *Ok**l* reflections present in the original material and in the 6-aminohexanoic acid-vermiculite were as follows:

0,2,*l* when $l = 2n + 1$; 0,4,*l* when $l = 2n + 1$; 0,6,*l* when $l = 2n$ and 0,8,*l* when $l = 2n + 1$. Those *Ok**l* reflections in the ornithine-vermiculite had both *k* and *l* even. The extent to which stacking disorder affects these specimens can be judged from the degree of streaking along *c** of the 0,2,*l* and the 0,4,*l* reflections, as these are sensitive to disordering of those atoms whose *y* coordinates are not multiples of *b*/3 (Brown and Bailey, 1962). By using these criteria we judged the ornithine-vermiculite to be well ordered, the natural material slightly less so and the 6-aminohexanoic acid-vermiculite the least ordered of all.

Space group C2 was chosen for the ornithine-vermiculite and Cc for the 6-aminohexanoic acid-vermiculite, as calculations within these groups allowed sufficient degrees of freedom to subsequently refine the positional parameters of the silicate atoms.

By using CoK α radiation and multiple-film-pack Weissenberg photographs intensity data were initially recorded for the 00*l*, *Ok**l* and *h*0*l* reflections for each of the two complexes. Subsequently intensity data for 406 observed reflections were recorded for the first 6 levels about *b* for the ornithine complex. All intensity measurements were made by visual comparison with a set of standards, obtained by timed exposures of a selected 00*l* reflection oscillated over a small angular range. Such comparisons were quickly made and since the standards were similar in shape to the unknowns some allowance could be made for streaking. Corrections were applied for Lorentz and polarization factors, and for the absorption factor by the integration method of Busing and Levy (1957); $\mu \approx 95 \text{ cm}^{-1}$ for CoK α radiation.

STRUCTURE DETERMINATIONS

Phases were computed from the known configuration of the silicate part of the structure and assigned to the observed structure amplitudes. Such phasing should be very nearly correct because the contribution to the total scattering by the interlamellar material is comparatively small. The positional parameters for the atoms of the silicate structure required by the analysis of the sample which we have utilized, were taken from Mathieson and Walker (1954) modified for the *c* axes of the unit cells of our materials.

One-dimensional Fourier projections

Initially one-dimensional Fourier projections were computed from the 00*l* structure factors for each of

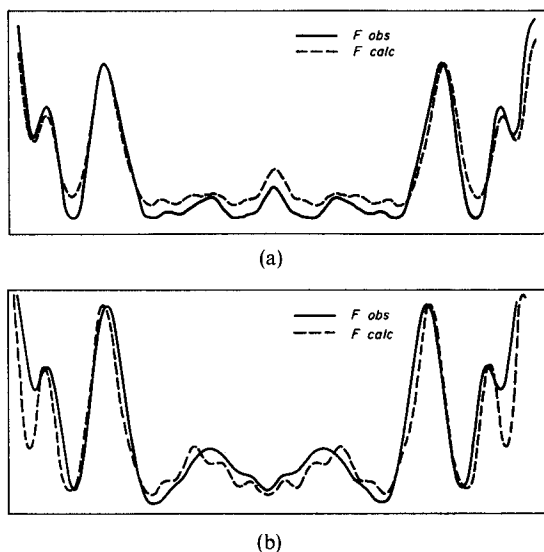

Fig. 1. One dimensional electron density function from F_{obs} — and F_{calc} --- for (a) 6-aminohexanoic acid-vermiculite and (b) ornithine-vermiculite.

the complexes. Figures 1(a) and (b) show the electron density distributions of 6-aminohexanoic acid-vermiculite and of ornithine-vermiculite projected onto the c axes of the respective unit cells.

In contrast with Kanamaru and Vand's (1970) result for the 6-aminohexanoic acid-vermiculite, which they prepared at a pH of 5.5, our material projects with a comparatively high peak at the middle of the interlayer region. From this and the i.r. study, we were able to postulate a "stair type" configuration

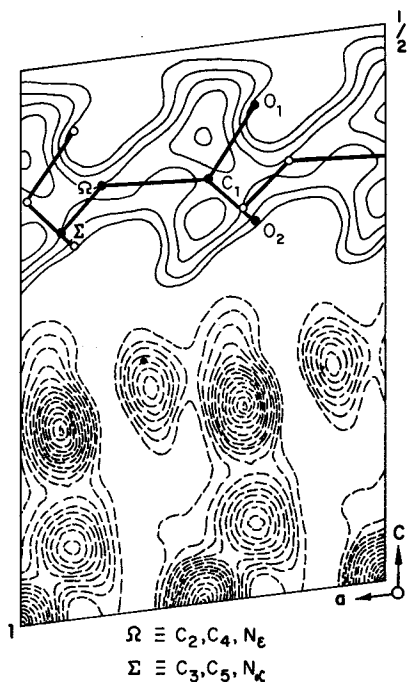

Fig. 2(a)

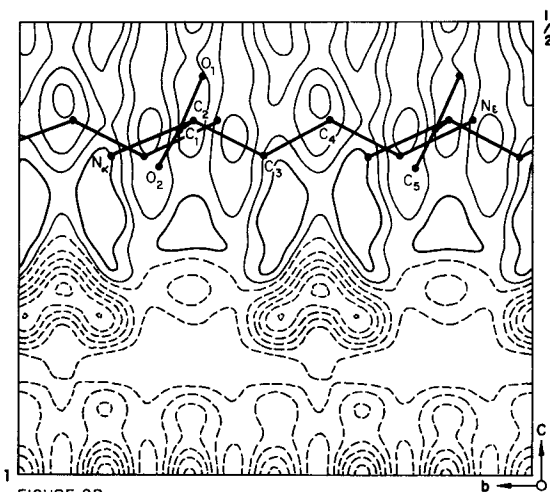

Fig. 2(b)

Fig. 2. Electron density function and structural model for ornithine-vermiculite projected in (a) upon the (010) plane and in (b) upon the (100) plane. Solid contours at intervals of $1 \text{ e}\text{\AA}^{-2}$. Dashed contours at intervals of $3 \text{ e}\text{\AA}^{-2}$.

for the organic molecules. The equivalent projection of the structure of ornithine-vermiculite, Fig. 1(b), shows two broad peaks; one on either side of the middle of the interlayer region. Our result is similar to that obtained by Rausell-Colom and Fornés (1974) and supports their hypothesis that the ornithine molecules are parallel to the silicate surface. The carbon chains of the organic molecules in the materials which we studied, therefore, seemed to have contrasting orientations. Two-dimensional Fourier analyses were used to fix the orientation of the organic molecules more precisely.

Two-dimensional analyses

The phased $h0l$ and $0kl$ structure factors were used to compute electron density and difference electron density projections on the (010) and (100) planes for each of the complexes. Figures 2 and 3 show the electron density projections for each complex. In both cases, peak heights in the interlammellar regions of the (010) projections tend to be stronger than peak heights in the interlamellar regions of the corresponding (100) projections. This could be the result of overlap in the (010) projections or that the chains of the organic molecules have considerable components along the b axes of the vermiculite cells. Possible orientations of the organic molecules, including those suggested by the i.r. studies of Raupach and Janik, were tested visually by optical projection of scaled molecular models onto the electron density projections. By this simple means models were derived for the two organic vermiculites which not only agreed with the evidence from the one-dimensional projection, but also yielded suitable interatomic distances with respect to the adjacent silicate surfaces.

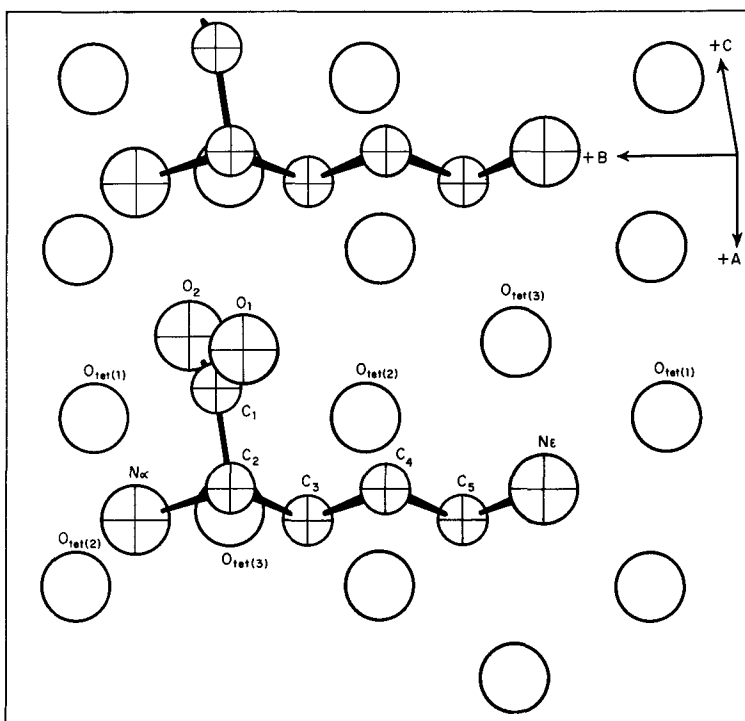

Fig. 3. The structure of ornithine-vermiculite viewed approximately along the c axis.

THE STRUCTURE OF ORNITHINE-VERMICULITE

Figure 2(a) shows the unique portion of the electron density projection on the (010) plane of a unit cell; superimposed upon this are schematic projections of ornithine molecules oriented with their alkyl chains parallel to b and with their zig-zag planes tilted at an angle of about 50° to the silicate surface. The C_1 - C_2 bonds are approximately parallel to that surface. The planes which contain O_1 , O_2 and C_2 are tilted at approximately 25° away from the ac plane. Figure 2(b) shows two molecules related by the $(\frac{1}{2}, \frac{1}{2}, 0)$ translation, projected upon the electron density projection on the (100) plane. This model was chosen as a basis for the calculation of a three-dimensional set of structure factors which were compared with their experimental equivalents.

Refinement of the model was carried out using the Least Squares Program of Busing *et al.* (1962). The isotropic temperature factor for all the atoms in the silicate sheets was left at $1.2 \times 10^{-16} \text{ cm}^2$; the value determined by Mathieson and Walker (1954) and used in all of our calculations. Temperature factors for atoms of the organic molecules were set at the reasonable value of $2.5 \times 10^{-16} \text{ cm}^2$. After a full-matrix least-squares adjustment of the interlayer scale factors the positional parameters for the silicate atoms were adjusted. Least squares adjustment of the positional parameters of the organic atoms produced slight shifts which were meaningless in comparison with the associated errors, but trial and error shifts of these parameters enabled us to finally reduce the

overall R factor to 31.5%. This rather large value reflects the difficulty of obtaining accurate intensity data even from selected crystals of these complexes. The final positional parameters are given in Table 1 which also sets out the results for the significant interatomic distances. No attempt was made to calculate the errors associated with these parameters, but if they are compared with their equivalents, reported by Chiba *et al.* (1967) in their crystallographic study of 1-ornithine hydrochloride, errors in the corresponding interatomic distances might be as large as 0.2 Å.

Three-dimensional Fourier analysis of ornithine-vermiculite

Following the full matrix least squares adjustment of the interlayer scale factors, three-dimensional Fourier and difference Fourier syntheses were prepared. Although the interlamellar regions in both of these syntheses were similar, certain differences were noted. Some peaks on the mirror planes ($y = 1/6$ and $y = 2/3$) were broad in both maps, but tended to be weaker in the difference synthesis. However, strong sharp peaks (designated as atom X in Table 1) were observed in these planes at coordinates generated by the space group from $x = 0.944$ and $z = 0.218$. These peaks were about half the height of those for the silicate oxygen atoms and about twice the electron density of any observed in the interlamellar space. The strength of the peaks implies a fairly high occupancy factor for any atom or ion of low scattering power. The distances from the centres of the oxygen atoms,

Table 1. Final atomic coordinates and interatomic distances for ornithine-vermiculite (S.G.5)

Atom			
(Mg, Fe, Ti, Mn) _{oct} (1)	0.000	0.000	0.000
(Mg, Fe, Ti, Mn) _{oct} (2)	0.000	0.333	0.000
(Mg, Fe, Ti, Mn) _{oct} (3)	0.000	0.667	0.000
(Si, Al, Fe) _{tet} (1)	0.387	0.001	0.172
(Si, Al, Fe) _{tet} (2)	0.410	0.333	0.169
O _{oct} (1)	0.368	0.000	0.068
O _{oct} (2)	0.352	0.337	0.066
O _{oct} (3)	0.360	0.659	0.067
O _{tet} (1)	0.144	0.407	0.201
O _{tet} (2)	0.143	0.927	0.203
O _{tet} (3)	0.429	0.187	0.202
N _ε	0.790	0.123	0.393
N _z	0.897	0.833	0.351
C ₅	0.897	0.263	0.351
C ₄	0.790	0.399	0.393
C ₃	0.897	0.532	0.351
C ₂	0.790	0.670	0.393
C ₁	0.494	0.694	0.382
O ₁	0.358	0.648	0.443
O ₂	0.358	0.739	0.339
Atom X	0.944	0.164	0.218
Interatomic distances (Å)			
O ₁ -C ₁	1.23		
O ₂ -C ₁	1.15		
C ₁ -C ₂	1.62		
C ₂ -C ₃	1.51		
C ₃ -C ₄	1.47		
C ₄ -C ₅	1.50		
C ₅ -N _ε	1.53		
N _z -O _{tet} (1)	3.00		
N _z -O _{tet} (2)	2.74		
N _z -O _{tet} (3)	2.75		
C ₃ -O _{tet} (1)	4.51		
C ₅ -O _{tet} (2)	3.27		
O ₂ -O _{tet} (3)	3.41		
O ₂ -O _{tet} (2)	3.13		
O ₂ -O _{tet} (1)	4.02		
Atom(X)-O _{tet} (1)	2.47		
Atom(X)-O _{tet} (2)	2.42		
Atom(X)-O _{tet} (3)	2.79		

forming the smallest of the two interpenetrating isosceles triangles and the unexplained peaks are 2.42 Å and therefore preclude the possibility of their being water molecules—sodium, magnesium or calcium are small enough to statistically occupy the ditrigonal holes formed by the surface oxygens.

A study of the interlamellar region of the difference map revealed eighteen additional peaks which could have been possible locations for the atoms of the organic molecule. The most definite of these had coordinates suggestive of some zig-zag chain of carbon atoms parallel to the *b* axis and with *x* coordinates of 0.397 or 0.897, as previously inferred from the two-dimensional analysis. All peaks found in this initial study were used to augment the "silicate only" model from which a new set of phases were computed for a second difference Fourier synthesis. Although several doubtful peaks observed in the first synthesis were still weaker in the second, a careful study of

the remainder threw little light upon the probable disposition of the carboxyl region of the molecule. Three peaks were possible real atoms but their coordinates only approximated to likely values; in addition five other peaks remained unexplained. Even if we allow that some of these may be allocated to water molecules, we must conclude that there are other possible locations for ornithine molecules, but with a lower probability of occurrence than for that proposed.

Table 2. Final atomic coordinates and interatomic distances for 6-aminohexanoic acid-vermiculite (S.G.9)

Atom	<i>x</i>	<i>y</i>	<i>z</i>
(Mg, Fe, Ti, Mn) _{oct} (1)	0.000	0.000	0.000
(Mg, Fe, Ti, Mn) _{oct} (2)	0.000	0.333	0.000
(Mg, Fe, Ti, Mn) _{oct} (3)	0.000	0.667	0.000
(Si, Al, Fe) _{tet} (1)	0.397	0.000	0.082
(Si, Al, Fe) _{tet} (2)	-0.397	0.000	-0.082
(Si, Al, Fe) _{tet} (3)	0.397	0.333	-0.083
(Si, Al, Fe) _{tet} (4)	-0.397	-0.333	-0.083
O _{oct} (1)	0.358	0.000	0.025
O _{oct} (2)	-0.358	0.000	-0.031
O _{oct} (3)	0.358	0.333	0.032
O _{oct} (4)	-0.358	-0.333	-0.032
O _{oct} (5)	0.358	0.667	0.029
O _{oct} (6)	-0.358	-0.667	-0.033
O _{tet} (1)	0.148	0.414	0.097
O _{tet} (2)	-0.148	-0.396	-0.097
O _{tet} (3)	0.148	0.954	0.097
O _{tet} (4)	-0.148	-0.909	-0.097
O _{tet} (5)	0.432	0.167	0.097
O _{tet} (6)	-0.432	-0.167	-0.097

The atomic parameters for the organic molecule are quoted to imply centrosymmetric pairs.

N	0.858	0.151	0.149
C ₆	0.858	0.151	0.190
C ₅	0.858	0.318	0.204
C ₄	0.858	0.335	0.250
C ₃	0.858	0.500	0.263
C ₂	0.858	0.506	0.312
C ₁	0.858	0.654	0.319
O ₁	0.634	0.763	0.331
O ₂	1.044	0.768	0.317
Water	0.375	0.396	0.250

Interatomic distance (Å)

O ₁ -C ₁	1.64
O ₂ -C ₁	1.44
C ₁ -C ₂	1.32
C ₂ -C ₃	1.66
C ₃ -C ₄	1.58
C ₄ -C ₅	1.57
C ₅ -C ₆	1.60
C ₆ -N	1.40
O ₁ -O _{tet} (1)	3.33
O ₁ -O _{tet} (2)	3.27
O ₁ -O _{tet} (3)	3.13
O ₁ -O _{tet} (4)	2.92
O ₁ -O _{tet} (5)	
O ₁ -O _{tet} (6)	> 3.5

The distances from the N atom to the nearest 6 oxygens forming the ditrigonal hole range from 2.70 Å–3.47 Å.

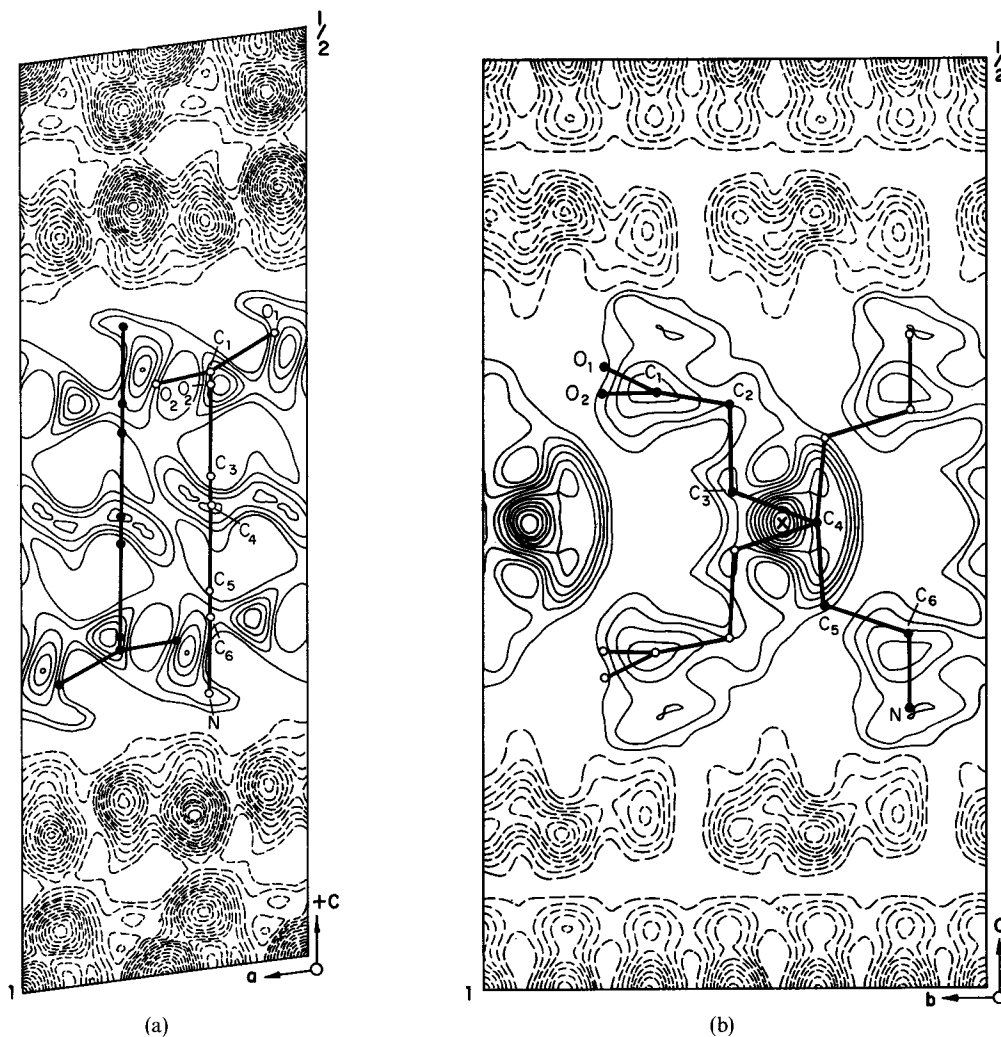

Fig. 4. Electron density function and structural model for 6-aminohexanoic acid-vermiculite projected in (a) upon the (010) plane and in (b) upon the (100) plane. Solid contours at intervals of $1 \text{ e}\text{\AA}^{-2}$. Dashed contours at intervals of $2 \text{ e}\text{\AA}^{-2}$.

Figure 3 is a schematic drawing of an ornithine molecule, showing its relation to the structure of vermiculite. This illustration shows how the dimensions of the ornithine molecule allow it to interact easily with the charged surface. For example the total length of the zig-zag chain in projection is very close to the distance between the centre of a particular silicate tetrahedron and the centre of an adjacent hexagonal hole, just beyond the next tetrahedron.

THE STRUCTURE OF 6-AMINOHEXANOIC ACID-VERMICULITE

Figure 4(a) shows the electron density projected on to the (010) plane of the unit cell. Superimposed upon this is a schematic drawing of the 6-aminohexanoic acid molecule with its $\text{N}_\epsilon\text{-C}_6$ bond perpendicular to the silicate surface. Figure 4(b) shows the molecule drawn upon the electron density projected onto the (100) plane. The model shown in these drawings for

the structure of 6-aminohexanoic acid is that reported by Bodor *et al.* (1967). The height of the strong peak on the middle of the interlayer region is partly accounted for in our model by atoms C_3 and C_4 of ascending and descending molecules, and would also be partly accounted for by water molecules if these form bridges between pairs of organic molecules, which seems not unreasonable. Since occupancy of possible sites by organic molecules is statistical in character we postulate that some of the interlamellar water molecules are alternative occupiers of these sites and the rest are randomly packed between the silicate sheets. Introduction of the organic and water molecules into the silicate-only model enabled the positional parameters and the site occupancy factors for the non-silicate atoms to be refined. The F factor for the $Ok1$ reflections changed from 0.40 to 0.28 and that for the $h0l$ reflections from 0.26 to 0.23. Table 2 lists the final atomic parameters and shows a selection of bond lengths. Again the errors associated with

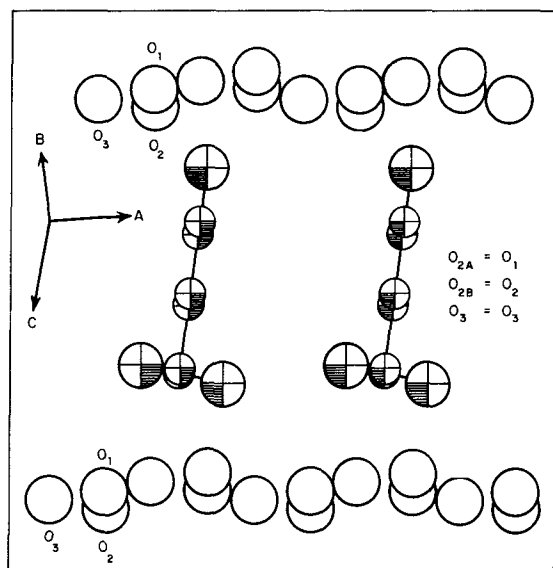

Fig. 5. The structure of 6-aminohexanoic acid-vermiculite viewed along the b axis.

these are of the order of 0.2 \AA and reflect the difficulties of obtaining accurate intensity data from complexes of vermiculite and amino acids. Figure 5 is a schematic drawing of the organic molecule shown in relation to the adjacent oxygens.

DISCUSSION

A parallel i.r. study of ornithine- and 6-aminohexanoic acid-vermiculites, by Raupach and Janik (1976) shows the amino acid molecules in both of these materials to be in a cationic form and very likely bonded to the silicate surfaces through nitrogen atoms. Their i.r. model for ornithine-vermiculite is substantially the same as that suggested by the X-ray work, but for 6-aminohexanoic acid-vermiculite Raupach and Janik have proposed a model, based upon the relevant transition moment directions, in which the C_6-N_6 bond of the organic molecule is not perpendicular to the silicate surface. Evidence from other transition moment directions, requires the plane of the zig-zag chain of the organic molecule to be tilted away from the normal to the silicate surface but still with a stair-type of configuration with respect to it. The i.r. and X-ray models are in substantial agreement; they both position the alkyl chain with a stair-type configuration stretching away from the silicate surface.

Our model for ornithine-vermiculite is substantially similar to that suggested by Rausell-Colom and Fornés (1974). It only differs from theirs with respect to the configuration of the ornithine molecule. This difference relates to the position of the α nitrogen, which the crystallographic study by Chiba *et al.* (1967) shows to be within the plane of the zig-zag aliphatic chain and not in the plane of the carboxyl group.

The specific structure proposed here for ornithine-vermiculite, may be only a favored arrangement amongst several alternatives; as we have pointed out, unexplained peaks (which may be spurious) remain in the three-dimensional Fourier maps. In addition, the occupancy factors (0.25–0.30) for the sites required by our model are less, when determined from the X-ray data, than the expected value of 0.34 obtained by dividing the exchange capacity (1.37) by the number of equivalent sites per cell (4, in space group C2). This enhances the probability of there being several alternative configurations for the ornithine molecules with respect to the surface. Our work has been unable to specifically locate the water molecules of the structure, because we believe, these will essentially have z coordinates similar to those of the carbon atoms as well as similar scattering power. We therefore postulate that the water molecules occupy sites on the silicate surface unoccupied by organic molecules. The F_{calc} curve of Fig. 1(b) is based upon a model without water and is therefore lower than the F_{obs} curve in the region about $z = 0.37$ where we suppose the water to be.

Our structure for 6-aminohexanoic acid-vermiculite requires the organic molecules to "key" into the silicate surface. The interlayer height available to accommodate them is approximately 7.8 \AA but the organic molecules have a vertical height of 6.0 \AA from centre of nitrogen to centre of oxygen, plus the sum of the van der Waal radii (3.5) for ammonium at one end and oxygen at the other. This "keying" into the surfaces of the silicate sheets by the ϵ nitrogens and the O_1 atoms of the organic molecules facilitates hydrogen bond formation between these atoms and the nearest surface oxygens. Table 2 shows that several of those interatomic distances which involve either N_6 or O_1 and the surface oxygens are consistent with hydrogen bond formation, although most seem to be too great. At the low pH used for the reaction between vermiculite and 6-aminohexanoic acid, the organic molecules carry single positive charges and hence the carboxyl groups will be in the form

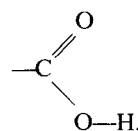

Each carboxyl group might therefore be expected to form a single hydrogen bond with the adjacent surface. Table 2 shows that only one of the six interatomic distances involving carboxyl and surface oxygens, is less than 3.0 \AA , that between O_1 and O_{let} (4), and therefore likely to represent a hydrogen bond distance.

The model suggested for the 17.32 \AA phase of 6-aminohexanoic acid-vermiculite by Kanamaru and Vand (1970), differs from our model for the double cell complex ($c = 34.09 \text{ \AA}$) in that the earlier workers placed the organic molecules in two layers with long chains parallel to the b -axis. Fourier maps produced

from their data differ from our own maps mainly in the region at the centre of the interlayer space where we find appreciable electron density. This difference probably is due to the higher concentration of positively charged organic ions at the lower pH, at which we formed our complex.

The fact that organic cations can influence the type and perfection of stacking of silicate layers reflects a subtle balance between the electrical and geometrical properties of the organic molecules and those of the silicate surface. In their discussion of the orientation of the silicate layers in vermiculite Calle *et al.* (1975) were able to relate the polytype to the polarizing power of the interlayer inorganic cation. Such a simple concept as this seems inapplicable to organic cations because of their more complex shape and charge distribution. In general terms one might expect these charged groups to seek points of opposite charge upon the silicate surfaces. For vermiculite, the surface charges will be localized near those tetrahedra in which aluminium has substituted for silicon. The energy necessary to change from one polytype to another will be obtained from the electrostatic field between the positive charges upon organic cations and the localized negative charges associated with the silicate surfaces.

Although ornithine and 6-aminohexanoic acid impose different stacking sequences upon the silicate sheets of vermiculite there is a common factor associated with the resulting polytypes; shifts between adjacent layers are chiefly in the *b* direction. This is implied by the fact that the patterns of their *h0l* reflections are similar and therefore lead to similar (010) projections of the silicate sheets. In addition their β angles are the same, namely 97° . However an unpublished study of lysine-vermiculite shows it to have a two-layer structure with a β angle different from 97° , thus implying a relative shift between adjacent sheets along the *a* direction in addition to likely shifts along *b*. From our study of these complexes between amino acids and vermiculites it has become apparent that much still remains to be understood of the mechanisms whereby organic cations influence the polytype of the complex formed. Work in this laboratory continues upon this problem, and also upon the

identification of the species near the centres of the ditrigonal holes of the silicate surfaces, as seen in the three-dimensional study of ornithine-vermiculite.

Acknowledgements—The authors gratefully acknowledge helpful criticism by Dr. K. Norrish and also wish to thank him for supplying the analysed vermiculite used for the work.

REFERENCES

- Boder, G., Bednowitz, A. L. and Post, B. (1967) The crystal structure of ϵ -aminocaproic acid: *Acta Cryst.* **23**, 482–490.
- Brown, B. E. and Bailey, S. W. (1962) Chlorite polytypism—I. Regular and semi-random one layer structures: *Am. Miner.* **47**, 819–850.
- Busing, W. R. and Levy, H. A. (1957) High-speed computation of the absorption correction for single crystal diffraction measurements: *Acta Cryst.* **10**, 180–182.
- Busing, W. R., Martin, K. O. and Levy, H. A. (1962) ORFLS, A Fortran crystallographic least-squares program: Oak Ridge National Laboratory, Tennessee.
- Calle, C. de la, Suquet, H. and Pezerat, H. (1975) Glissement de feuillets accompagnant certains échanges cationiques dans les monocristaux de vermiculites: *Bull. Gr. Fr. Arg.* t. XXVII, 31–49.
- Chiba, A., Ueki, T., Ashida, T., Sasada, Y. and Kakuda, M. (1967) The crystal structure of L-ornithine hydrochloride: *Acta Cryst.* **22**, 863–870.
- Iglesias, J. E. and Steinfink, H. (1974) A structural investigation of a vermiculite-piperidine complex: *Clays & Clay Minerals* **22**, 91–95.
- Kanamaru, E. and Vand, V. (1970). The crystal structure of a clay-organic complex of 6-aminohexanoic acid and vermiculite: *Am. Miner.* **55**, 1550–1561.
- Mathieson, A. McL. and Walker, G. F. (1954) Crystal structure of magnesium-vermiculite: *Am. Miner.* **39**, 231–255.
- Mifsud, A., Fornés, V. and Rausell-Colom, J. A. (1970) Cationic complexes of vermiculite with L-ornithine: *Reunion hispano-belga de minerales de la arcilla*. Proc. Madrid pp. 121–127
- Raupach, M. and Janik, L. (1976) The orientation of ornithine and 6-aminohexanoic acid adsorbed on vermiculite from polarized i.r. ATR spectra. *Clays & Clay Minerals* **24**, 127–133.
- Raupach, M., Slade, P. G., Janik, L. and Radoslovich, E. W. (1975) A polarized i.r. and X-ray study of lysine-vermiculite: *Clays & Clay Minerals* **23**, 181–186.
- Rausell-Colom, J. A. and Fornés, V. (1974) Monodimensional Fourier analysis of some vermiculite-l-ornithine⁺ complexes: *Am. Miner.* **59**, 790–798.