

REVIEW ARTICLE

# Reconfigurable cable-driven parallel mechanism design: physical constraints and control

Elham Khoshbin<sup>1,2</sup> , Martin J.-D. Otis<sup>1</sup> and Ramy Meziane<sup>1,2</sup>

<sup>1</sup>LAR.i Lab, Applied Science Department, University of Quebec at Chicoutimi, Quebec, Canada

<sup>2</sup>ITMI (Technological Institute of Industrial Maintenance), Sept-Îles College, Sept-Îles, Canada

**Corresponding author:** Elham Khoshbin; Email: [Elham.khoshbin1@uqac.ca](mailto:Elham.khoshbin1@uqac.ca)

**Received:** 1 March 2024; **Revised:** 8 June 2024; **Accepted:** 30 June 2024

**Keywords:** cable-driven parallel mechanism; collision; physical constraints; sagging; reconfiguration; workspace; wrapping

## Abstract

The cable-driven parallel mechanism (CDPM) is known as an interesting application in industry to pick and place objects owing to its advantages such as large workspaces. In addition to the advantages of this mechanism, there are some challenges to improving performance by considering constraints in different components, such as the behavior of cables, shape, size of the end effector and base, and model of pulleys and actuators. Moreover, the impact of online geometry reconfiguration must be analyzed. This paper demonstrates the impact of these constraints on the performance of reconfigurable CDPM. The methodology is based on the systematic review and meta-analysis guidelines to report the results. The databases used to find the papers are extracted from Scopus and Google Scholar, using related keywords. As a result, the impact of physical constraints on system performance is discussed. A total of 90 and 37 articles are selected, respectively. After removing duplicates and unrelated papers, 88 studies that met the inclusion criteria are selected for review. Even when considering the physical constraints in modeling the mechanism, simplifications in designing a model for the reconfigurable CDPM generate errors. There is a gap in designing high-performance controllers to track desired trajectories while reconfiguring the geometry, and the satisfaction of physical constraints needs to be satisfied. In conclusion, this review presents several constraints in designing a controller to track desired trajectories and improve performance in future work. This paper presents an integrated controller architecture that includes physical constraints and predictive control.

## 1. Introduction

Cables in cable-driven parallel mechanism (CDPM) are capable of pulling the end-effector but not pushing it, resulting in inherent limitations for these systems. The unique feature of using cables instead of rigid links to move loads has made CDPM popular choices in various fields. Despite their advantages, such as high rigidity, low weight, high load capacity, less error compared to serial mechanisms, and less energy consumption, CDPMs still face challenges in improving their performance. The Sharing Production Activities in Dynamic Environment project proposes a human–robot collaboration strategy for moving or lifting industrial objects. This project aims to enhance the performance of CDPMs in industrial applications. The development of geometry reconfiguration changes the workspace size and geometry and improves the system quality compared to other parallel robots. For such mechanisms, the development of cable tension distribution techniques, motion modeling, and control methods presents significant challenges. Caro and Merlet, 2020 [1] investigated potential physical failures that may occur during human–robot collaboration in CDPMs, as follows:

1. Cable breaking or deformation of cables due to their mass (the cables are considered as a straight line in several papers);
2. A mechanical failure in the reel;

3. An encoder, motor, or control module failure;
4. Cables stuck in the reel/pulleys to ensure operator safety;
5. Collision avoidance in all forms (between cables, between cables, and obstacles/end effector) and
6. Lower accuracy in position of end effector due to error in measurement length of cables.

This study highlights the impact of physical parameters (including cable properties, shape and size of the end effector and base, location of attachment points, pulleys, and actuator choice and design) on the performance of CDPMs. These parameters become more important for analysis, while reconfiguration of the geometry is applied online on a CDPM because the geometry of the workspace is modified, and the motion of the attachment points has some impact on the model error. Moreover, the physical constraints in cables, collision avoidance, and singularity can affect the performance of the system. In addition, reconfiguration can address these constraints by moving the attachment points, wrench generation capability, and transparency, which are essential for human–robot collaboration. Furthermore, the motion of cables in CDPMs can present several challenges, which can be addressed using the following approaches:

- 1) Adjust the cables' length using a motorized reel and pulley system.
- 2) Modifying the position of attachment points on the base or end effector using reconfiguration of the geometry [2].

This review paper focuses on the physical constraints in the geometry of the CDPM, allowing a better reconfiguration of the CDPM geometry, including cable constraints, collision avoidance, and singularity. The contribution of this paper is to suggest a design process and steps to allow the reconfiguration and control architecture of the CDPM while considering safety issues, modelization accuracy, and constraints. To the best of the authors' knowledge, a design strategy is not fully detailed in previous literature reviews related to the CDPM reconfiguration of the geometry. Therefore, section 2 outlines our methodology for identifying relevant papers to be included in the review to define a design strategy for the CDPM to add the reconfiguration of the geometry, including a control strategy. In section 3, the results of the review are presented by analyzing the contribution of each study in tables divided by the main characteristics of each study. The design strategy with the control architecture is presented in the final section of this paper.

## 2. Methodology

This paper presents a comprehensive systematic review of the physical models and constraints that must be considered to achieve high-performance (R)CDPMs<sup>1</sup> for use in human–robot collaboration tasks. By analyzing the relevant literature, this paper aims to identify the key factors that influence the performance of (R)CDPMs and provides insights into future directions for improving their effectiveness in human–robot interaction scenarios. According to the contributions of this paper, the main research questions are as follows.

How is the reconfigurable CDPM applicable in the human–robot collaboration process by considering physical constraints? Therefore, the following research questions are introduced as the main objectives of this review:

- 1- How (R)CDPM can be applicable in the industry?
- 2- What are the challenges, advantages, disadvantages, and limitations of (R)CDPM?
- 3- Which physical constraints can affect the performance of (R)CDPM?
- 4- How reconfiguration can affect the performance of CDPM?
- 5- How accuracy and precision could be improved in (R)CDPM?

To answer these questions and suggest a design strategy and control architecture, a search strategy is presented in the following section, using specific keywords to identify the papers that meet our

<sup>1</sup>Reconfigurable Cable Driven Parallel Robot.

review criteria. By analyzing the selected papers, we aimed to provide acceptable answers to the research questions that motivated this study.

### 2.1. Search strategy

To our knowledge, there has been little research on modeling reconfigurable CDPM for human–robot collaboration tasks while considering physical constraints such as collision avoidance, payload, cable wrapping, and cable sagging. Therefore, to analyze the latest information available over the past nine years, we conducted a comprehensive systematic literature review of papers published between 2015 and 2023.

The review methodology is primarily based on the guidelines provided by Boolean [3]. A comprehensive search for relevant papers on Scopus and Google Scholar using the search terms in the publication titles, abstracts, and keywords is conducted in this paper. Subsequently, an initial selection to eliminate irrelevant research and duplicate papers is performed. This paper aimed to investigate the impact of physical constraints on (R)CDPM, with a primary focus on human–robot collaboration, to improve the performance of (R)CDPM. Accordingly, the keywords are selected as follows.

( TITLE-ABS-KEY ( cable AND driven AND parallel AND robot ) OR TITLE-ABS-KEY ( cable AND driven AND parallel AND mechanism ) OR TITLE-ABS-KEY ( cdpr ) OR TITLE-ABS-KEY ( cdpm ) OR TITLE-ABS KEY ( wire AND driven AND parallel AND mechanism ) AND TITLE ( collabora\* ) AND ABS ( collaborate\* ) )

Despite conducting an extensive search using the selected keywords, a limited number of relevant papers that met the inclusion criteria are encountered. Therefore, to provide a comprehensive review, this review paper is divided into three sections.

**a.** Impact of physical constraints on (R)CDPM: In addition to considering physical constraints, CDPM components to design CDPM are discussed, such as pulleys, motors, and cable models, which can significantly impact the modeling of the system. A precise mechanism model can improve the performance and stability of (R)CDPM.

**b.** Papers on (R)CDPM:

This section discusses the relevant literature on the reconfiguration of the CDPM, which is a critical aspect of enhancing the system’s flexibility and adaptability.

**c.** Papers on (R)CDPM in Human–Robot Collaboration: The papers in this section focus on the utilization of (R)CDPM in the human–robot collaboration process, which requires a high degree of accuracy, safety, and user-friendliness.

By analyzing the relevant literature, the key challenges, opportunities, and future directions for enhancing the performance of (R)CDPM in the human–robot collaboration process are discussed in this paper.

**Keywords for physical constraints of CDPM:**

1. **Sagging**

( TITLE-ABS-KEY ( cable AND driven AND parallel AND robot ) OR TITLE-ABS-KEY ( cable AND driven AND parallel AND mechanism ) OR TITLE-ABS-KEY ( cdpr ) OR TITLE-ABS-KEY ( cdpm ) AND TITLE ( sag\* ) AND ABS ( sag\* ) )

2. **Wrapping**

( TITLE-ABS-KEY ( cable AND driven AND parallel AND robot ) OR TITLE-ABS-KEY ( cable AND driven AND parallel AND mechanism ) OR TITLE-ABS-KEY ( cdpr ) OR TITLE-ABS-KEY ( cdpm ) AND TITLE ( wrap\* ) AND ABS ( wrap\* ) )

### 3. Creep

(TITLE-ABS-KEY(cable AND driven AND parallel AND robot ) OR TITLE-ABS-KEY ( cable AND driven AND parallel AND mechanism ) OR TITLE-ABS-KEY ( cdpr ) OR TITLE-ABS-KEY ( cdpm ) AND TITLE ( creep ) AND ABS ( creep ))

### 4. Unstable payload

( TITLE-ABS-KEY ( cable AND driven AND parallel AND robot ) OR TITLE-ABS-KEY (cable AND driven AND parallel AND mechanism) OR TITLE-ABS-KEY ( cdpr ) OR TITLE-ABS-KEY ( cdpm ) AND TITLE-ABS-KEY ( unstable AND payload )

### 5. Singularity

( TITLE-ABS-KEY ( cable AND driven AND parallel AND robot ) OR TITLE-ABS-KEY ( cable AND driven AND parallel AND mechanism ) OR TITLE-ABS-KEY ( cdpr ) OR TITLE-ABS-KEY ( cdpm ) AND TITLE ( singular\* ) AND ABS ( singular )

### 6. Collision avoidance

( TITLE-ABS-KEY ( cable AND driven AND parallel AND robot ) OR TITLE KEY (cable AND driven AND parallel And mechanism) OR TITLE-ABS-KEY ( cdpr ) OR TITLE-ABS-KEY (cdpm) AND TITLE (collision) OR TITLE (interference) AND ABS(collision) OR ABS (collision))

### 7. Reconfiguration

( TITLE-ABS-KEY ( cable AND driven AND parallel AND robot ) OR TITLE-ABS-KEY (cable AND driven AND parallel AND mechanism) OR TITLE-ABS-KEY ( cdpr ) OR TITLE-ABS-KEY ( cdpm ) AND TITLE (reconfigure\*))

By analyzing the selected papers using specific keywords, this review will aggregate recent studies on the advantages, drawbacks, and challenges of (R)CDPMs, suggest new research approaches for future projects, and identify areas that require further investigation.

## 2.2. Data extraction

The data extraction process primarily involves the selection of physical constraints and reconfiguration approaches that directly impact the performance of the CDPM. The results of a thorough search conducted using Scopus and Google Scholar are presented in Table I.

## 2.3. Physical constraints with PRISMA method

Figure 1 presents the components of (R)CDPM. The PRISMA method, as illustrated in Figure 2, is utilized to identify and analyze the relevant literature on the physical constraints of the CDPM. Initially, 114 papers are identified and screened and 88 remained after the screening process. Eligible papers included both journal articles and conference papers. The results of the analysis are discussed in detail in the following section.

## 3. Results

The focus of this review is the utilization of (R)CDPM in industrial applications, where the use of lightweight components is critical for the ease of relocation and installation. A cable system is an

**Table I.** Parameters that impact the performance of reconfiguration for a cable-driven parallel mechanism related to its workspace.

	Scopus 90	Relevant paper of Scopus 64	Relevant paper of Google Scholar 37
Cable sagging	21 papers	16 papers [4–19]	12 papers [20–31]
Cable wrapping	6 papers	5 papers [32–36]	2 papers [37, 32]
Creep	2 papers	2 papers [38, 39]	2 papers [40, 41]
Unstable payload	1 paper	1 paper [42]	0
Singularity	7 papers	5 papers [4, 14, 43–45]	1 paper [46]
Collision avoidance	15 papers	11 papers [47–57]	13 papers [2, 58–69]
Reconfiguration	38 papers	24 papers [2, 47, 57, 59, 61, 63, 65, 70–86]	7 papers [56] [58, 62, 80, 87–89]

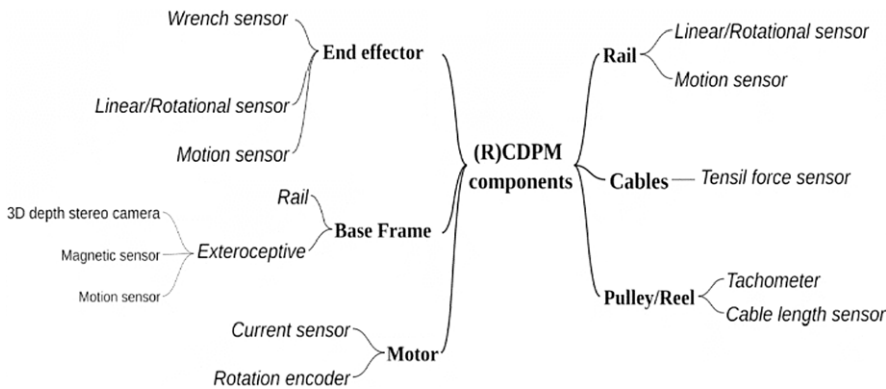

**Figure 1.** Components of the (R)CDPM.

appropriate choice for (R)CDPM due to its lightweight nature. The design of each component must consider different approaches in order to accommodate a large workspace. This section illustrates the five-step process of mechanical design, as shown in Figure 3.

**Step1. problem definition:** In this step, the identification of CDPM’s application in various fields, such as industry, rehabilitation, and medicine, is accomplished based on the fulfillment of specific requirements.

**Step 2: Mechanical design and software simulation:** Subsequently, the mathematical formulation of the mechanical design is identified in two distinct parts.

**Step 2.1. Topology design:** This step involved the type and topology design of the mechanical structure of the CDPM. This includes identifying the number of degrees of freedom, shape of the end effector and base frame, type of transmission system, and the degree of redundancy. Six types of DOFs for CDPM are presented by Verhoeven [90]: pure translational motion of 1, 2, and 3 DOFs (1T, 2T, and 3T) with the point end effector, and the 2T1R, 3T2R, and 3T3R (T denotes translation and R denotes rotation) DOFs based on the nonpoint end effector.

**Step 2.2. Size and dimension design:** The dimensions of the end effector and base frame are determined in this step. This is a critical aspect of design as it involves determining the optimal dimensions for the CDPM. Kelaiaia et al. 2012 [91] proposed an Atlas approach and a cost function approach for dimensional synthesis. The cost function in this paper is proposed to optimize the system while considering several constraints.

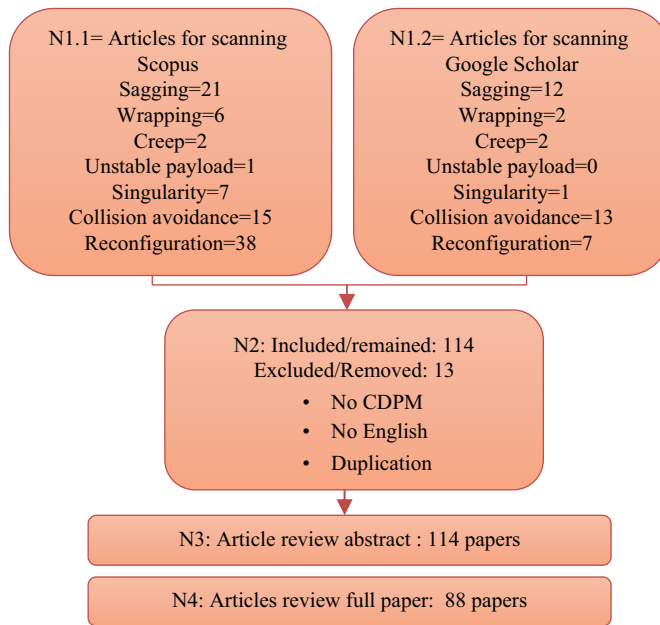

Figure 2. PRISMA research method.

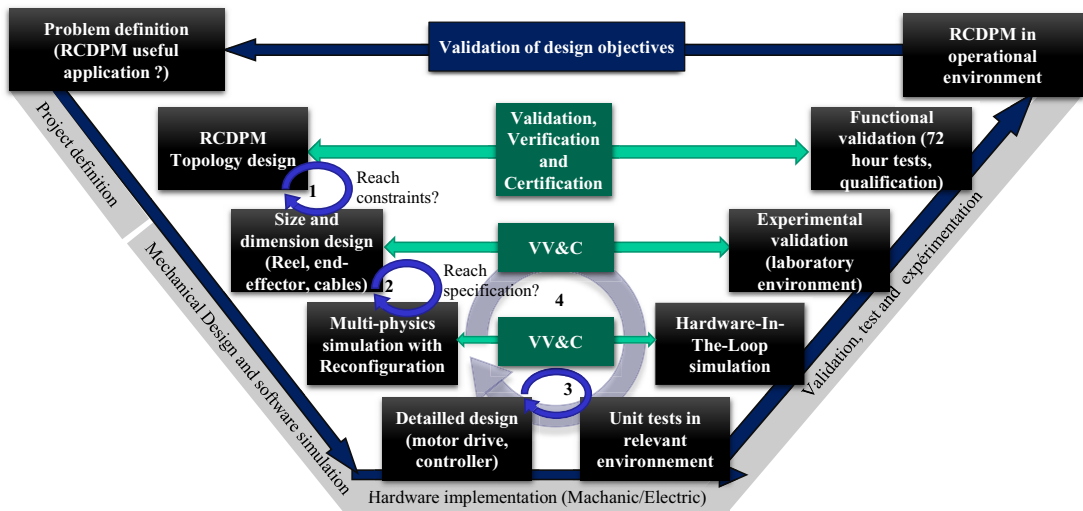

Figure 3. RCDPM incremental V-cycle (V-Model XT) with virtual prototyping (1 and 2) and iterations based on component implementation (3) and component integration (4).

**Step 3. Hardware implementation:** This step involves the hardware of the CDPM structure components, such as the motor drive and controller.

**Step 4. Validation, Test, and Experimentation:** The validation is a functional and experimental validation. This is the final step to prove that the CDPM meets all required standards. Figure 3 shows the details of all four steps.

This review primarily focuses on steps 2 and 3, as well as several challenges that enhance the (R)CDPM performance. Section A discusses the impact of physical design parameters, such as the type and dimensions of the components (i.e., cables, end effector, base frame, sensors, and actuators), on the

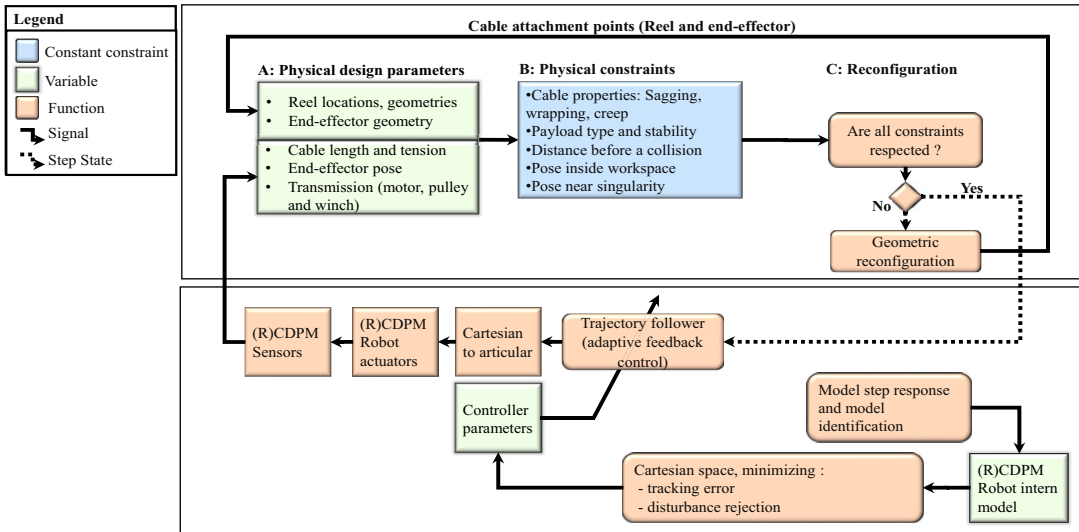

Figure 4. Physical constraints impact on the reconfiguration.

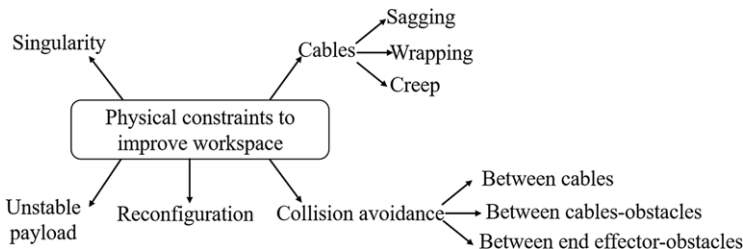

Figure 5. Concepts of the (R)CDPM design (physical constraints).

(R)CDPM performance. Section A.1 discusses the physical parameters, which consist of the mechanical parameters of the cables, and section A.2 discusses the geometrical parameters of the transmission system, end effector, and base frame. Section B introduces some of the constraints faced by (R)CDPMs and their impact on performance, such as physical constraints in cables, collision avoidance, instability, and payload, which impact the workspace and performance of the CDPM. Figure 4 indicates sections A and B and shows how reconfiguration in section C is used to avoid collisions between humans and cables. The next section of this paper is divided into three sections.

### 3.1. Physical design parameters

Mechanical design is important in describing a (R)CDPM. Improving the mechanical behavior of the mechanism can significantly improve the performance of the (R)CDPM. Schmidt, V. L. 2017 [92] discusses several components of the (R)CDPM, which are available in Figure 5.

Some of the most important parameters include:

1. Cable parameters such as cable length, cable mass, cable diameter, number of cables, and material of cables
2. Geometrical parameters of CDPM including the size and shapes of the base and end effector, actuators, and pulleys
3. Payload

To improve the performance of (R)CDPM, each component requires a mathematical model in the control scheme to improve the performance of the R-CDPM. In some research papers, these models are considered in the dynamic or kinematic aspects of the control scheme [40]; however, in many studies, these models have been ignored [47].

To improve the accuracy of CDPR kinematic and dynamic models [93] and enhance CDPM performance, one approach is to use a kinematic model that considers pulleys and a model of a continuous-mass elastic cable.

For instance, motorized reels are used to coil cables, whereas some studies utilize pulleys to direct cables from winches to cable attachment points. The pulleys in the geometric model can enhance the estimation of the payload center of mass [94]. By selecting the optimal values for these physical parameters, it is feasible to design a CDPM that satisfies the specific performance requirements for a given application. In subsection (A.1), the cable's physical parameters, which affect the high performance of the CDPM, are discussed. Due to nonlinear friction and model error, sensorless methods that rely on motor current for wrench estimation are less accurate than sensor-based approaches. Exteroceptive sensors are recommended to ensure accurate end-effector pose measurements despite system perturbations and modeling errors.

### 3.1.1 Mechanical properties of cables

The cables are used as the connection elements of the CDPR end effector to a fixed base frame, and significantly influence the performance of the robot. Generally, cables are good at transmission and weak at constraints. Cables can produce only positive tension, which has nonlinear features such as rigidity (with a linear or hysteresis model [95, 96], damping [95], operating preload, creep [40], sagging due to heavy weight cables, deformation of cables, wrapping, lifetime (preload and sagging are not intrinsic cable properties), and stiffness. These mechanical properties of cables can influence the CDPR performance, add complexity to the dynamic model of the CDPM, and may cause unexpected vibration at the end effector. In addition, neglecting these nonlinear features in a dynamic model of the CDPM to design a controller increases the tracking errors. The physical parameters of the cables are as follows:

**Cable mass:** The gravitational force acting on heavier cables may experience greater vibration, elasticity, and wrapping. Particularly, in the context of large workspace applications with heavy cables, the sagging of cables can add complexity to their modeling [97]. Active cable tension control systems can also be used to maintain optimal tension in cables regardless of their mass.

**Cable length:** *The cable length can be changed using winches actuated by motors fixed on the base frame.*

The gravitational force acting on the cables induces tensile stress that causes elongation in their length, leading to sagging. Longer cables pose a higher risk of entanglement with other cables, which can impede robot performance. Cables that exceed the optimal length may exhibit heightened vibration and slackness, which can compromise the stability of the system and increase the risk of collision or other operational hazards, thereby undermining the safety, reliability, and efficiency of robotic systems.

Meanwhile, the controller is required to track the desired trajectory, but cable deformation can increase the cable length and cause deviations in the position and orientation of the end-effector. However, this deformation cannot be easily measured in practice. Piao et al. 2017 [40] proposed an elongation compensator (precise cable deformation). His model is a serial combination of a linear spring and two Voigt models and is a function of the payload and cable length. This paper consists of two parts. The first part is inverse kinematics to compute the desired length of the cables. Inverse kinematic is used for massless inextensible cables in the CDPM. However, it becomes a nonlinear kineto-static problem by considering the mass and elasticity of the cables. It is important to note that cable length can also affect the robot's workspace and performance, as longer cables can limit the robot's speed and motion range.

**Cable diameter:** An increase in cable diameter results in a decrease in sag due to the increased moment of inertia. Larger diameter cables exhibited greater vibration resistance. Cables with smaller



diameters may increase the risk of collision due to increased bending and deformation. Although the internal configuration of cables can lead to variations in their diameters, these changes are typically negligible, and the diameter of the cable is considered constant [96].

**Cable stiffness:** A parameter that can affect the stiffness of the (R)CDPM is cable stiffness. The cable stiffness can be considered as linear [98]. By considering the cable model and its stiffness in the design of the controller (to track the desired pose of the end effector), the system can be made more accurate and better able to evaluate the stability in the presence of mechanical uncertainties and disturbances. Stiffer cables are less likely to sag and wrap, which improves the accuracy and precision of the CDPRs. They are also better equipped to resist deformation and bending because of their high-frequency vibrations. The cable stiffness is related to the Young's modulus, which is a measure of the material's resistance to deformation under stress. Active cable tension control systems can be highly beneficial for managing cable stiffness and reducing any potential vibrations. With these types of systems, the tension in the cables is adjusted to optimize the stiffness and limit any sagging or vibration. This is especially crucial for CDPMs that have considerable movement and require precise control.

**Cable material:** Mechanical phenomena can vary depending on the cable material used. Different materials, such as steel [26], ultrahigh-molecular-weight polyethylene (Dyneema<sup>®</sup>), Spectra<sup>®</sup>, and aramid (also named Kevlar<sup>®</sup>), are used for cable construction. To compare the effects of different cable materials and structures on the CDPM behavior, static and dynamic models of a CDPM are established and parameterized with cable properties. The mechanical properties of the cables, including the stiffness, damping, hysteresis, and creep, are compared in Table II using an evaluation ranging from 1 (low) to 5 (high). As can be seen in Table I, the steel cable has a higher value than the Dyneema and Kelvar cables. However, this evaluation can be adapted by considering the requirements of the final application. For CDPM, if weight and flexibility are critical factors, Dyneema might be the best option because of its high strength-to-weight ratio and flexibility, whereas the creep in Dyneema is higher than that in steel and Kelvar. Steel may be more suitable for applications requiring high strength and durability. Kevlar can be a good middle ground with a balance between strength, weight, and durability.

It is important to note that the elastic modulus for Dyneema is not constant and the viscous effect must be considered. Conversely, with steel cables, there is no need for a preliminary loading cycle and the creep effect must not be considered. For example, Gueners et al. 2021 [99] compared aramid, Dyneema, and steel cables. Materials with higher Young's moduli are less elastic and tend to be less prone to sagging and wrapping. The IPAnema cable robot presented by Miermeister et al. 2015 [100] used Dyneema cables that have a lower weight but a more complex elastic behavior in the most relevant force transition element. The findings of this study indicate that Dyneema polyethylene cables exhibit time-varying elastic behavior and are susceptible to overload-induced changes. Moreover, hysteresis effects have been observed in these cables.

**Viscoelasticity of cables:** Polymer cables improve the performance dynamics in high-payload CDPM systems due to their low inertia effect and low friction between moving parts. However, their viscoelastic behavior and elasticity can lead to imprecise position control, resulting in errors in tracking set points and feedback loop outputs. To improve the performance of the CDPM, the viscosity of the cable is considered in the controller design [101]. The elongation of polymer cables can cause errors in the position of the end-effector, particularly for heavy payloads.

Piao et al. 2017 [40] developed a mathematical model of polymer cable deformation using a five-element cable model with a series combination of a linear spring and two Voigt models for pick-and-place applications. The viscoelastic cable model is defined using a brute force method, and the errors in cable length due to viscoelastic effects through position control under a heavy payload, based on the identified viscoelastic cable model, are compensated. The goal is to improve the accuracy of the pick-and-place operations, particularly for high-payload applications.

Korayem, M. H., 2020 [101] used the Gibbs–Appell formulation to obtain a dynamic equation by considering the viscoelasticity of cables. Subsequently, a feedback linearization controller, along with

*Table II. Comparison between cables.*

<b>Material</b>	<b>Damp</b>	<b>Hysteresis effect</b>	<b>Preload handling</b>	<b>Deformation resistance</b>	<b>Suitability of linear elastic model</b>	<b>Load cycles to have a repeatable behavior</b>	<b>Creep</b>	<b>Mass for the same length and diameter</b>	<b>Minimum elastic bending radius</b>	<b>Gap between simulation and experiment</b>	<b>Value</b>
Ultra-high-molecular weight polyethylene (UHMWPE/Dyneema®)	Moderate (3)	Very low (5)	Low (2)	Low (2)	Low (2)	Higher repeatability of load cycles (2)	Higher (2)	Low (5)	Small (5)	High (2)	30
Kelvar (aramid)	High (4)	Low (4)	Moderate (3)	Moderate (3)	Moderate (3)	Higher (3)	Moderate (3)	Moderate (4)	Small (5)	Moderate (3)	35
Steel	Low (2)	High (2)	High (5)	High (5)	High (5)	Lower (5)	Extremely lower (5)	High (2)	Large (2)	Low (5)	38

two other controllers (optimal controller and finite horizon model predictive controller), is proposed to track the payload tracking task in a wide workspace.

Korayem et al. 2017 [102] developed a dynamic model of the CDPM that considers the viscoelastic properties of the cables. The feedback linearization gains are obtained using the LQR method to balance the control input and tracking error. The system states are estimated using the LQG method in the presence of noise, which is assumed to be the result of the end-effector vibrations caused by cable elasticity.

**Cable lifetime:** Cable lifetime is a crucial factor in CDPM design. Real cables can achieve a reasonable lifetime only if the minimum bending radius is exceeded. Furthermore, the friction on the attachment points can reduce the lifetime of the cables.

**Temperature:** Temperature variations can exert a substantial influence on cable material properties, such as the Young's modulus and thermal expansion coefficient, thereby leading to modifications in cable stiffness and length. Thermal expansion of cables can cause sagging and wrapping, which can result in unwanted vibrations. Increased temperatures can also reduce cable stiffness, rendering them more elastic. To mitigate the effects of temperature variations on cables, active tension control and temperature compensation techniques can be employed, which can effectively counteract the negative impact on cables and alleviate sagging in the (R)CDPM. More details on these challenges are discussed in the following sections.

### 3.1.2. Geometrical parameters of the transmission system, end effector, and base frame

CDPMs comprise a base frame, an end effector, pulleys, winches, and actuators. The point-to-point straight-line model neglects pulley and cable shapes. The CDPM can be designed by considering geometrical constraints. Cables are wound on winches, guided by pulleys, and connected to the end effector on the opposite side. There is a correlation between the dimensions of these components and the performance of the CDPM in terms of the static and kinematic equilibria of the end effector. Moreover, the mass, shape, and size of the end effector can significantly affect several physical constraints of a CDPM, including sagging, wrapping, collision, vibration, elasticity, workspace, and singularity.

**Mass of end effector and base frame:** The mass of the end effector and base frame is crucial in the CDPM design. The mass of the end effector influences cable sagging, wrapping around pulleys, vibration, and singularity issues. To improve the performance of the CDPM, the end-effector mass must be increased to have a larger gravitational force or springs can be added [103]. Picard et al., 2018 [104] design a PD controller with real-time mass estimation and compensation in feedforward terms for a suspended CDPM. This mechanism is used to select and place objects of different shapes, sizes, and masses. Dynamometers quantify the force exerted by individual cables on a moving platform and are used to evaluate the payload mass in real time. Increasing the payload mass improves the performance of the controller compared to its two counterparts.

**Shape and size of the end effector and base frame:** The size and shape of the end effector and base frame exert a substantial impact on the center of gravity, which in turn increases the tension and sagging in the cables. The shape and size of the base frame can affect the singularity of the robot by constraining its motion in specific directions. Asymmetrical or irregularly shaped end effectors and base frames heighten vibrations, leading to cables wrapping tightly around the pulleys and constraining the robot's range of motion and accuracy. Additionally, larger end effectors hinder the robot's ability to navigate around obstacles and increase the risk of collisions with nearby objects. There are two geometric models of the end effectors: Init X and Optim. Init X has a shape similar to a parallelepiped, with attachment points located on both the upper and lower planes. It also has vertical plane symmetry, and its cables are crossed as in the IPanema robot family [105]. In Optim geometry, the attachment points are determined through estimation to maximize the stiffness of the end effector within the workspace. In addition, this design aims to prevent collisions between cables connected to the same plane.

**Attachment points:** Attachment points are fixed to the base and end effector with single holes [106] or ceramic guidance [107] used to minimize cable friction. Deflection pulleys are commonly used in

CDPMs with one or two pulleys fitted with plain or ball bearings. Multidegree-of-freedom pulleys are used for lifting, with 2DOF pulleys having a rotation axis aligned with the cable direction [108]. One pulley attachment point is constant on the fixed base frame. Additionally, attachment points can include additional guides.

Hay and Snyman 2005 [109] utilized a dynamic optimization algorithm to estimate the optimal attachment point on the base of a planar CDPM, taking into account the maximum workspace. The connection between the attachment points on the base and end effector is symmetrically distributed and consists of four modes: non-cross, horizontal-cross, vertical-cross, and double-cross connections. A cable with a small diameter is attached to the end effector with a knot or crimped through a hole [106]. Additional guidance elements are used in large-scale applications.

**Pulley:** Simplifying pulleys as ideal points and ignoring cable elasticity is a common approach for researching the connection between the cable and base frame. However, this point-to-point assumption oversimplifies the robot model and can cause errors in the trajectory of the end-effector. This approach is accurate only when the cable radius is small or the CDPM span is large. Calculating the tangent points and wrap angles of the cables in the pulleys is essential for this approach. Wang et al, 2019 [86] presented four categories for cable outlet mechanisms on the base: eyelet, single-pulley, double-pulley, and multipulley types. In scenarios where the cable outlet point is fixed, the eyelet type is ideal. However, the relative motion between the cable and eyelet can cause friction, cable breakage, and reduced accuracy. To address this issue, the pulley can be presented as an RRP kinematic (spatial) or an RP kinematic (planar). To address these errors, Gonzalez-Rodriguez et al. [110] proposed a method for mounting compensation pulleys at the cable attachment point on the end effector. However, although this method is suitable for planar CDPRs, it is not appropriate for low-speed spatial CDPRs.

Paty, Thibaut, et al. 2021 [111] modeled two types of pulleys: a single revolute joint pulley and a new double revolute joint pulley. They then compared the accuracy of the end-effector pose with those of the new pulleys and conventional pulleys. For cables of short lengths, it may be possible to replace the winch with a linear actuator. The combination of a linear actuator and a hoist system can increase the cable length. Pott, A. 2012 [105] introduced a kinematic model of the pulley mechanism used in winches for CDPMs. It also proposes a pulley friction compensation method for winch-integrated cable force measurement in CDPMs.

**Actuator:** When designing a CDPM, the designer must consider factors such as motor power and actuator capacity. The capacity of an actuator is a crucial parameter that affects the size of the workspace.

Gagliardini et al. 2015 [112] presented an optimization problem that focuses on the design procedure, specifically the sizing of the actuators such as motors, winches, and gearboxes (which connect the winches to the motors) to enhance the Twist Feasible Workspace).

Banadaki, S.M.D., 2007 [113] presented the mechanical design of CDPMs comprising motor selection, speed reduction mechanism, cable-winding mechanism, end-effector design, and base design. In a specific study, four Aerotech DC1017 servomotors are utilized with an encoder fixed at the end of each motor to read the angular position. The cable winding unit in this investigation consists of a motor, speed reduction mechanism, and threaded drum with shafts and bearings.

**Motor:** The tension in the cables can be estimated by utilizing the current measurements and estimating the motor torques. However, this method may not be effective in cases of high friction stemming from the transmission systems. Therefore, a force sensor can be attached to the attachment points on the end-effector to mitigate this issue [114]. Furthermore, it is possible to attach a force sensor to an intermediate pulley. Ottaviano, E. 2007 [115] demonstrated that an error greater than 1 N is observed between the theoretical estimation and the force sensor, due to the presence of vibrations and the friction of the pulleys.

**Winch:** Inclusion of the winch geometry can enhance the positional accuracy. The winch, where the cable is wound, is one of the most intricate mechanical components of a CDPM. Inaccuracies in this component can result in high geometric errors and adversely affect the performance of the CDPM. As a solution, many CDPMs utilize electric motors to regulate the cable length. However, the cable is wound freely, making it difficult to control the wind on the winch. A thread on the winch to constrain the lateral

winding of the cable is proposed to avoid cable winding on the winch and improve the cable winding precision [116].

Nevertheless, the primary drawback of this approach is the lack of a fixed attachment point, which necessitates integration of the cable position on the winch into the geometric model of the CDPM. Another method is discussed in [108] to move the winch in both translation and rotation. To address these issues, the attachment points can be stabilized by selecting an appropriate reduction ratio between the pitch of the drive screw and diameter of the winch. However, this method may result in a reduced dynamic performance due to both translational and rotational inertia. Alternatively, a rotating threaded winch and fixed attachment point can be utilized, such as a simple hole or pulley with two degrees of freedom in rotation, as demonstrated in IPANema 3 [116]). The Skycam winch does not employ a thread but instead utilizes cable winding guidance through the use of pulleys, translational guides, and a drive screw. Heap et al 2022 [117] presented lightweight and small winches with high force capabilities.

### 3.2. Physical constraints

Therefore, careful consideration of CDPM constraints, such as cable physical constraints (cable sagging, wrapping, collision avoidance, creep, and sagging), and implementation of appropriate techniques can significantly enhance the overall performance and accuracy of the CDPM.

There are the following challenges which need to be considered.

1) CDPMs are susceptible to cable wear and breakage during operation, which presents a challenge in ensuring their reliability and longevity. The lack of research and standards related to the durability of CDPMs, including guidelines for detecting and replacing worn cables, makes it difficult to ensure their sustainability and dependability.

2) Ensuring the precise maintenance of CDPMs is challenging because of various factors, such as cable reconfiguration, nonlinear cable deformation, long-term tension, and induced cable creep. This decline in accuracy significantly affects the effectiveness of the CDPMs, particularly in industrial settings. One possible solution is the implementation of rapid self-calibration techniques.

3) In certain applications where high bandwidth or system stiffness is required [118], uncontrollable vibrations can pose a significant challenge.

Controlling vibrations in CDPMs is challenging due to the flexibility and low rigidity of cables. Existing vibration suppression methods lack versatility and often require expensive high-performance controllers. To address these issues, a unified framework for hardware and software control is required. Increasing the natural frequency is one way to reduce the vibration of the mechanism. The relationship between the natural frequencies of CDPMs is affected by the relationship between the shape of the end effector and the shape of the frame. A linear equation of motion is proposed using the Lagrange approach. Different end-effector shapes can result in varying natural frequencies [119].

4) The rapid development cycle of CDPMs is impeded by insufficient industrial infrastructure, including the absence of high-performance cables, drive modules, and control systems. In addition, the lack of mature software for efficient analysis and development presents a significant challenge.

5) The rapid development cycle of CDPMs is impeded by insufficient industrial infrastructure such as high-performance cables, drive modules, and control systems. Furthermore, the absence of mature software for efficient analysis and development is a significant challenge.

6) In CDPMs, workspace analysis is a critical challenge that is more significant than rigid mechanisms due to the complexity of the design parameter constraints, which may be coupled with cable tension. The workspace is an essential parameter for designing, controlling, and implementing CDPMs because it defines the space in which the end-effector can operate under varying position and orientation constraints. CDPM workspaces are sets of end-effector poses that satisfy geometric constraints, force balancing, and structural stiffness with boundary conditions such as force, impact moment, and noise.

Several methods are proposed to determine the workspace.

a) The first method involves continuing with common algorithms for interval analysis. Lamine et al. 2016 [120] established a workspace for a planar three-degree-of-freedom (3DOF) CDPM with four cables and a six-degree-of-freedom (6DOF) spatial CDPM with eight cables, utilizing interval analysis techniques. Additionally, the minimum size of CDPM required to achieve a given workspace is analyzed.

b) The second method employed in this study is the point-wise approach, which involves utilizing a finite set of discrete points to ensure compliance with workspace constraints.

Pusey et al. [121] introduced a pointwise method and performance index to assess the impact of a robot's structure, including the size of the fixed and end effectors, on the workspace size.

c) A third approach is the analytical method, which relies on the workspace boundary and geometric relationships between the end effector and cable lengths. This method uses kinematic equations to define the hull of the workspace and offers improved accuracy compared to point-wise methods. It is commonly employed for straightforward mechanism geometry and is relatively easy to implement.

d) Another method for calculating the workspace is the hybrid method, which combines both the analytical and numerical methods. With this approach, analytical methods are used to determine the workspace boundaries, whereas numerical methods are used to calculate the workspace points within those boundaries. Hybrid methods offer a more accurate and efficient calculation of the workspace than analytical or numerical methods alone.

To calculate the workspace that satisfies the geometric constraints in a CDPM, it is necessary to have a thorough understanding of the various constraints involved. The workspace of the mechanism is determined by considering these constraints. For instance, the workspace must be constrained within the free workspace to prevent collisions with obstacles in the environment and to avoid singularities, which are configurations in which the robot loses one or more degrees of freedom. Additionally, the physical constraints of the robot structure limit the joint angles. The workspace of the robot could not exceed the maximum length, tension, and joint angles. Furthermore, the workspace of two CDPMs with the same base frame size is dependent on the size and shape of the end effector as well as the positions of the attachment points on the base and end effector. To further enhance the workspace and performance of CDPMs, it is necessary to delve into the details of several constraints, including physical constraints in cables, reconfiguration, collision avoidance, singularity, and an unstable payload.

### *3.2.1. Physical constraints in cables*

Cable tension is a critical issue affecting the vibration, control, and performance of CDPMs. Several constraints, including the energy efficiency, uniformity of cable forces, and stiffness, must be considered when determining a solution for cable forces. The tension of cables must be monitored to ensure reliable operation, and this can be achieved in two ways. First, the current consumption and properties of the motors can help estimate the tensile forces (tension) in the cables. Second, a more accurate approach involves adding a force sensor around the attachment points of cables in the reel. Alternatively, the third approach is to add a force sensor to the end-effector side for each cable. The first approach, which involves measuring the current in the motor, is suitable for mechanisms with extremely low inertia and friction. The second approach reduces the impact of the nonlinear properties of the reel; however, it is important to note that the cable should not exhibit significant sagging.

The third approach is necessary for situations where sagging is a critical concern. In such cases, measuring the tensile force difference between the attachment on the reel and the attachment point on the end effector is necessary to improve the estimation of the current state of the mechanism. A constraint exists in cable tension, with tension limited between the minimum tension to prevent sagging and the maximum tension to avoid excessive friction between mechanical components, which can lead to vibration and potential cable ripping [122]. The stiffness of CDPMs can be limited by the maximum tension in cables [123], due to mechanical cable resistance or actuator torque limitation.

In fully constrained CDPMs, there are infinite combinations of cable tensions that can balance a desired Cartesian wrench because the number of cables is higher than the degrees of freedom while

satisfying the limitations of lower and upper tension in the cables. As the tensile force increases, the vibration in the end effector is reduced quadratically; however, it cannot be eliminated as the principal frequency harmonics of the vibration increase and could become audible. Furthermore, active cable tension control systems can be utilized to maintain optimal tension and minimize vibrations in the cables. Vibration damping materials can also be employed to reduce cable vibrations and improve the performance of CDPM.

**a) Cable sagging:** To mitigate cable sagging, the minimum tension bound should be elevated. In many robotic systems, cables are treated as massless and have a negligible impact on dynamic analysis when compared to rigid bodies; however, this assumption is not valid for larger CDPMs [8].

In high-payload scenarios, where an encoder is used at the reel, the elongation of the cables can cause an error in the positioning of the end effector. In ref. [31], the Irvine sagging cable model is utilized to account for the cable elasticity and deformation caused by cable mass in CDPMs. However, a limitation of CDPMs is cable sagging during the end-effector movement. The inclusion of cable mass in workspace analysis presents further challenges, and reducing the cable tension to mitigate sagging could result in decreased end-effector stiffness and increased sagging. Alternatively, increasing tension may not be a reliable solution for addressing cable sagging. The optimal tension distribution algorithm optimizes the lower tension constraint by minimizing energy consumption, friction, vibration, and other factors. The algorithm estimates cable sagging by analyzing the lengths of the cables exceeding a certain threshold and their orientations.

Table III presents the cable sagging in the CDPM.

#### **b) Cable Wrapping:**

Occasionally, potential interference between the cable and rigid links of the mechanisms is considered. Wrapping the cable around a rigid link can significantly affect the workspace of CDPMs. In addition, cable length errors may arise due to cable wrapping. Table IV discusses the phenomenon of cable wrapping on the CDPM.

**c) Creep:** Continuous and slow deformation of a material under long-term constant mechanical stress is known as creep. This is a time-dependent parameter, and if left unchecked, can cause mechanical failure well below the yield strength of the material. If cable elongations due to creep are not compensated for, errors in cable lengths can reduce the accuracy of motion tracking. Several factors affect the creep behavior of polymer cables, including cable length, material mechanical properties, and temperature [39]. The creep behavior of polymer cables can have a negative impact, particularly in pick-and-place applications. Table V discusses the cable creep phenomenon in the CDPM.

### *3.2.2. Unstable payload*

In situations where the load is unstable, CDPMs may encounter issues, such as falling loads or posing a risk of injury to humans in the workspace. Automated construction or rapid transport of construction materials via mechanisms can be viable solutions to address such critical scenarios and reduce accidents. Some methods have proposed balancing the object on the end-effector as a means of preventing instability. Ali and Aphiratsakun 2015 [124] propose the implementation of PID controllers to balance a ball at the center of the end effector, starting from a random initial position. In addition, a method for recovering the positional control of the ball after applying an external disturbance to the end effector is proposed. The controller is designed to regulate the system for both scenarios with and without external disturbances. The proposed approach entails regulating the disturbance to recover the ball's position, which requires approximately 30 s to achieve in this application. Table VI presents the phenomenon of an unstable payload on the CDPM.

### *3.2.3. Collision avoidance*

CDPMs face distinct challenges when it comes to collision avoidance, including designing a geometry that prevents collisions, implementing real-time collision-detection algorithms, and determining

**Table III.** *Impact of cable sagging due to mass and elasticity on the CDPM/(R)CDPM.*

<b>Paper</b>	<b>DOF/ Cable</b>	<b>Application</b>	<b>Workspace</b>	<b>Points and Goal</b>
Merlet, J.-P.2016 [29]	6DOF (constant Rotation) 6 cables	–	Yes	1) Workspace discussion in two situations a) considering straight-line elastic cables b) considering sagging cables 2) Obtaining sagging cables by the computer-intensive algorithm after calculation of border workspace by considering constraints in tension
Chawla, 2021 [21]	Fully constraint planar 3 DOF	3D printing Construction	Wrench-feasible printable workspace	<ol style="list-style-type: none"> <li>Determination of workspace (with a generic algorithm) by considering cable sagging.</li> <li>Minimize sagging by determination of the selection criterion with factors: <ul style="list-style-type: none"> <li>Printable workspace</li> <li>Tension of cables</li> <li>End effector deflection.</li> </ul> </li> <li>Impact of varied geometric parameters on WFPW and capacity margins such as frame and end effector width and height and nozzle tube height</li> </ol>
Mamidi, T.K. and S. Bandyopadhyay, 2021 [20]	6-3 CDPM 8-8 CDPM, CoGiRo	Spherical radio telescope (FAST)	No	1) Discrete model of cable (mass, elasticity, and damping) and winches 2) Irvine’s model of cable to solve the kinetostatic problem. The shapes of the cables at the equilibrium configurations are the same as predicted by Irvine’s model. 3) Analysing constrained mechanical systems with a combination of Newton-Euler and Lagrangian dynamics
Tho, T.P. and N.T. Think, 2021 [22]	6 DOF 8 cables	–3D printing of concrete for construction	Wrench static workspace	1)Using a linear programming algorithm to compute the IK with the force equilibrium condition for the end effector. Using a Trust-Region-Dogleg algorithm to analyze cable sagging to improve the IK accuracy and control the robot. The dual simplex algorithm analyzes the tension of cables in combination with optimizing the minimum cable tension. 2) The cable tension and length of cables and sagging for a specified trajectory 3) Using load cell to measure the tension



*Table III. (Continued)*

<b>Paper</b>	<b>DOF/ Cable</b>	<b>Application</b>	<b>Workspace</b>	<b>Points and Goal</b>
Merlet, J.-P. 2021 [9]	-Planar 2 cables -Spatial 3 cables	–	No	1) Computation is FK and DK and investigation of the relation of FK and IK for CDPM with 2 sagging cables. 2) Sagging is important in IK/FK if load mass is lower than the threshold 3) When the load mass is high, the sagging can be neglected.
Merlet, J.-P. 2021 [10]	3 DOF 4 cables	Printing the wall of glass powder in the artistic exhibition.	No	1) Neglecting the elasticity of the cable material 2) Solve (FK) with the sagging of the cables. 3) Advantages and disadvantages of FK problems when only tensions or angles of cable are measured. 4) Effect of uncertainties for FK based on measurement of cable length, tension, and angles.
Merlet, J.-P., 2019 [23]	–	–	No	1) Analysis of the kinematic of CDPM with the model of cables (deformation and elasticity of cables) 2) Using the Irvine equation to improve the analysis computation time to solve IK and FK based on interval analysis
Merlet, J.-P., 2018 [15]	6 cables	MARIONET-CRANE (one of the largest CDPM)	Yes	1) Computation of the border of horizontal cross-sections of the workspace by an algorithm for a given altitude and orientation of the end effector. But there are some holes in the workspace which need to be discussed. 2) Considering singularity to recognize the border and separating workspace. 3) Comparison between ideal workspace and workspace with sagging
Gia Luan, P. and N. Truong Thinh, 2020 [12]	6 DOF 8 cables	–	Yes	1) Combination of the quasi-static model and inverse kinematic model of spatial CDPM with analytic and empirical is based Irvine model of cable sagging. 2) Finding the relationship between unstrained length L and tension exerted along the X-axis.
Hussein, H., M. et al. 2018 [24]	2 cables	–	No	1) The elastic catenary cable by considering cable mass and elasticity for three problems as cable length, endpoint positions, and forces is recognized by knowing the two others. 2) Discussion of the affection of flexural rigidity and shear forces
Ottaviano, E., et al. 2019 [25]	–	–	Yes	1) A model to determine achievable workspace given maximum sagging in cables. 2) Evaluation model of the cable by considering elasticity and sagging in exact positioning end-effector as a point mass in 2D.

*Table III. (Continued)*

<b>Paper</b>	<b>DOF/ Cable</b>	<b>Application</b>	<b>Workspace</b>	<b>Points and Goal</b>
Merlet, J.-P. 2017 [17]	Spatial CDPM with 2/3 cables	–	No	1) Adding the extra measurement sensors due to the difficulty of solving Direct kinematic 2) Using sensors to gather Partial or complete information on the cable 3) presenting DK solutions for two different cable models as ideal and elastic without deformation
Yuan, H., et al, 2016 [30]	6 DOF 8 cables	–	No	1) Force distribution method by considering the effect of cable sag 2) Improving the position accuracy of the end effector. 3) Propose a lower boundary based on the cable's fundamental frequency to evaluate the cable dynamic.
Merlet, J.-P. 2018 [31]	4 cables	–	No	1) Solving the direct kinematics (DK) based only on the cable length sensors is not a good candidate for CDPM with sagging in the cables. 2) Adding extra sensors to provide more accuracy such as a) Cable tensions sensor b) cable orientations sensor, c) end-effector orientation. The (a) and (c) sensors are not a good idea to solve the DK while (b) provide more accuracy in static poses or during a quasi-static motion.
Tho, T.P. and N.T. Thinh, 2021 [8]	6 DOF 8 cables.	–	No	1) Prediction of sagging in large-sized CDPM with ANFIS (adaptive neuro-fuzzy inference system) based on the kinematics problem 2) The input data for the ANFISs are kinematic structure and cable tension distribution which affect cable sagging 3) Fast calculation time and high precision.
Merlet, J.-P. 2015 [28]	ANR Cogiro project. 8 cables	No	No	1) Solving the inverse kinematics (IK) and forward kinematics (FK) 2) The sagging of cables is taken into account in the FK computation 3) Using Generic algorithms to solve the IK problem in CDPMs.
Liu, P. and Y. Qiu, 2015 [27]	–	–	No	Two steps are considered to obtain the cable tensions by considering sagging in cables. 1) An iterative process to compute the iterative cable tensions and 2) Optimization of the cable tensions produced in the previous step.

*Table III. (Continued)*

<b>Paper</b>	<b>DOF/ Cable</b>	<b>Application</b>	<b>Workspace</b>	<b>Points and Goal</b>
Yuan, H., et al, 2017 [26]	CoGiRo.6DOF 8 cables	–	No	1) Canceling the vibration by dynamic stiffness analysis to improve the tracking trajectory 2) Oscillation model is performed by the Lagrangian approach. 3) Analyzing the modal interaction between the modes of local cable and the global CDPM
Liu, P. and H. Ma., 2016, [19]	Spatial 4 cables	Large-scale manipulators	No	1) Model of cables as an inextensible catenary. 2) Demonstration of the effect of cable sagging on stability using the weighted method and tension distribution with an iterative optimization algorithm on cables.
Piao, J., et al., 2017 [40]	6 DOF 8 cables	Pick and place	No	1) Design elongation (precise cable deformation) compensator and design open-loop controller. by considering the five-element cable model (a serial combination of a linear spring and two Voigt models which is a function of payload and cable length).
Fabritius, M. and A. Pott, 2020, [13]	8 cables	–	Yes	1) Considering the cable sagging and pulleys in kinematics for high CDPM. 2) New kinematic code which considers both cable sagging and pulleys and makes the volume of the wrench-feasible workspace of the catenary-pulley model larger compared to previous codes. 3) Tension determination to avoid the sagging in cables
Tho, T.P., N.T. Thinh 2022 [5]	4 cables	–	Yes	ANFIS model to estimate the cable sag with low speed without considering the impact of cable elasticity.
Korayem, M. H. 2017 [18]	6DOF 6 cables	–	Yes	1) Cable flexibility and inappropriate tension distribution near workspace boundaries are major issues in cable robots due to long cable lengths. 2) Combining a cable robot with a wheeled mobile robot can allow for a larger workspace with shorter cable lengths 3)The combination of cable and mobile robots can distribute tensions appropriately since the end-effector does not need to approach the workspace boundary. 4) The study presents a dynamic model and control approach for a cable-suspended parallel robot with a wheeled mobile platform, considering the weight of the cable 5) The dynamic equations of the system are obtained using the Gibbs-Appel method, and the equations related to cable weight and sagging are added to the equations of motion 6) Control of the system using the feedback linearization method is presented, and the effect of cable sag on tension and end-effector pose is investigated

*Table III. (Continued)*

<b>Paper</b>	<b>DOF/ Cable</b>	<b>Application</b>	<b>Workspace</b>	<b>Points and Goal</b>
Merlet, J.-P. and R. Tissot, 2022 [6]	2 & 3 cables	–	No	Presenting a panorama to solve the IK/DK by cable sagging and discussing the advantages and drawbacks.
Fabritius, M. and A. Pott, 2020 [11]	8 cables	–	Yes	1) Workspace computation by novel forward kinematic approach by taking into account the cable sagging 2) Using the catenary-pulley model to demonstrate its impact on the workspace computation 3) The stiffness estimated by the new FK is lower than the standard geometric model
Merlet, J-P, 2018 [16]	MARIONET-CRANE 6 DOF, 6 Cables	–	Yes	1) Difficulty of workspace analysis due to the complexity of the cable model 2) Focus on suspended CDPR with sagging cables 3) Proposing an algorithm to calculate the border of horizontal cross-sections of the workspace based on the altitude and orientation of the platform. 4) Considering singularities in the kinematics equations to determine the border, and the workspace can be divided into several components depending on the branch of the inverse kinematics.
Yahia, Ichrak Ben, 2021 [7]	2-1 & 3-1 CDPM specific class of CDPM, called N-1	–	No	1) Performing the solution of (IK) and (DK) problems while considering the cable model, including sagging, elasticity, and mass. 2) The combination of the NN and the Newton method allows for the quick and accurate calculation of results with low computation time.
Merlet, J.-P, 2019 [14]	6 Cables,	–	Yes	1) The Irvine model takes into account the effect of sagging, leading to different singularities in the inverse and forward kinematics 2) The singularity in the inverse kinematics occurs at the boundary of the workspace. 3) When the solution branches of the inverse or forward kinematics intersect, both the inverse and forward kinematics have complete singularities.
Briot, S. and J.-P. Merlet, 2023 [4]	Planar 3 DOF	–	No	1) Present the computation of the geometric–static model of planar CDPRs based on Irvine’s model by considering sagging in cables 2) Discussion of stability analysis.

**Table IV.** Impact of cable wrapping due to mass and elasticity on the CDPM/(R)CDPM.

Paper	DOF, Cables	Application	Workspace	Points and Goal
Lei, M.C. and D. Oetomo. 2015 [36]	3 DOF 4 cables	–	No	Presenting the kinematic modeling of a Cable-Driven Parallel Mechanism by considering wrapping the cables around rigid links.
Heo, J.-M., et al 2017 [37]	6 DOF 8 cables	–	Wrench feasible workspace	1) Considering a loss factor and the variation of the wrapping angle of the pulley in the model 2) Considering bearing friction in pulleys as the Coulomb friction model causes changing the wrench-feasible workspace 3) Changing tension in cables due to pulley bearing frictional force when the pulley rotates
Lei, M.C. and D. Oetomo, 2018 [35]	3 DOF 4 cables	–	No	Validation of Kinematic Model for CDPM with cable Wrapping around a cylinder.
Lei, M.C. 2020 [34]	6 DOF 4 cables	–	Yes	1) Considering the phenomenon of cable wrapping to deal with the collision between cable and body to solve inverse kinematics and dynamics of a CDPM. 2) Using optimization problem given the desired trajectory to compute force in cables. 3) Improving the accuracy of the model by allowing cable wrapping
Sun, C., et al., 2021 [33]	3 DOF 4 cables	–	Yes	1) Modify the attachment points on the end-effector without kinematic redundancy by considering the cable wrapping 2) Expanding the workspace, especially the rotation workspace.
Sun C., et al., 2022 [32]	6 DOF 8 cables	1)Haptic device (the payload placed on the side). 2)Industrial applications (payload is placed in the middle).	f\Force closure workspace	1) New spatial CDPM without additional actuator 2) Unlimited rotation axis 3) Cable wrapping over end-effector by adaptive guide ring 4) Changing the configuration of the end-effector by the guide ring

**Table V.** *Impact of cable creep on the CDPM/(R)CDPM.*

<b>Papers</b>	<b>Points</b>
Nanthacoumarane, S., et al. 2022 [41]	1) Difficulty of prediction of elongation in polymer cables under load due to the viscoelastic nature of these cables and reduce the accuracy of end effector positioning. 2) Using expensive tensile testing machines as traditional methods to discuss creep 3) Presenting an inexpensive way by using the experimental data from static load tests in this paper.
Piao, J., et al. 2018 [39]	1) Prediction of the creep behavior of polymer cables by using different mathematical models for loading and unloading motion. 2) Show the creep by using a model of the polymer cable made by the series combination of a linear spring and two Voigt models. 3) Representing the creep by payloads and cable length estimated according to the changes of actual payloads and cable lengths in static conditions.
Kieu, D.-V.N. and S.-C. Huang 2020 [38]	1) Describe the dynamic creep behaviors by the nonlinear dynamic model according to the viscoelasticity model 2) Improve the accuracy by compensating errors by cable elongation in the controller.
Piao, J., et al. 2017 [40]	1) Developing the mathematical model of polymer cable deformation using the five-element cable model, which consists of a linear spring and two Voigt models in series combination. 2) Defining the viscoelastic cable model using the brute force method, and the error in cable length due to the viscoelastic effect is compensated for through position control under heavy payload to improve the accuracy of pick-and-place operations for high payload applications.

**Table VI.** Impact unstable payload on the CDPM/(R)CDPM.

Paper	DOF, Cable	Application	Workspace	Points and Goal
Oyekan, and Grimshaw, 2020 [42]	CAROCA 8 cables	Construction	No	1) Using a ball plate system to stabilize the unstable payload 2) Recognition of the Pose of the ball on the end effector by image recognition (from a camera). 3) Reinforcement-learning trained neural network controller to balance an object on the end effector to track the desired trajectory 4) Using a PD torque controller in three cases to control each motor (i) a PD controller. (ii) a PD controller with only the end effector mass compensator (iii) a PD controller with real-time mass estimation and compensation

workspace limitations. One solution is to study the geometry reconfiguration, as the shape of the end effector or the number of cables can limit the stability, singularity, and wrench feasible workspace. Reconfiguration or changing the attachment location of the cables can help overcome these limitations. This review presents various methods for collision avoidance in CDPMs, including strategies for preventing collisions between cables, between cables and end effectors, and between cables and obstacles. These methods are presented in Tables VII and VIII. Table VII presents the collision avoidance (between cables and obstacles and between obstacles with end effectors) methods on the (R)CDPM, while Table VIII discusses the impact of collision avoidance between cables [2], between cable and human [47, 125], and between cables and end effectors on the (R)CDPM. In addition, several strategies can be used to detect interference-free constant-orientation workspaces.

In reference [126], the inverse kinematics problem for the mechanism and numerical solution for colliding wires are computed for a six-degree-of-freedom CDPM with negligible friction between the wires at the connecting points. Furthermore, a wrench-feasible workspace is identified in the upper bound of the colliding cables. The results reveal that the workspace is larger when cable collisions are permitted compared to a collision-free scenario.

To avoid collisions with obstacles and repel a mechanism approaching boundaries, the local artificial potential field (APF) [127] is utilized. The APF [128] approach utilizes attraction and repulsion functions to guide a mechanism toward a target while avoiding obstacles. Stability analysis is conducted using the Lyapunov function. Other approaches including sample-based methods [49], geometry-based methods [129], biased rapidly exploring random trees (RRT), and velocity obstacle-based methods [130] are used to update the path planning problem to avoid collision with moving obstacles. Carpio-Aleman et al 2018 [53] used a straightforward trigonometric calculation to determine the distance between the cables and end effector segment at regular intervals. Bak et al. 2019 [52] introduced a revised version of the goal-biased RRT algorithm, along with the Gilbert–Johnson–Keerthi algorithm, to address the issue of cable collisions by determining the distance between the mechanism limbs and fixed objects. Although various studies have proposed optimal designs and reconfigurable CDPM theories that rely on fixed configurations to avoid obstacles, their effectiveness in complex tasks and cluttered environments remains questionable due to the limited geometric configurations of the CDPM. Reconfiguration is achieved by relocating the attachment points on the base (motorized reel location) to enable the desired initial trajectory.

**Table VII.** *Impact of collision avoidance between cables and obstacle and between obstacle and end effector on the CDPM/(R)CDPM.*

<b>Paper</b>	<b>DOF, cables</b>	<b>Application</b>	<b>Workspace</b>	<b>Points and Goal</b>
Wang, B., et al. 2016 [57]	Reconfiguration Planar CDPM	–	Collision Free Force Closure Workspace (CFFCW)	1) A method to determine Collision Free Force 2) Positioning end effector in free collision path by considering the constraint 3) Moving attachment points fixed on a block linear or cyclic motion 4) Merging obstacles in the environment between two cables in one convex. 5) Determination of the range of motion in cables to obtain the force-closure constraint 6) Find a Workspace without collision between the end effector and obstacles
Bordalba, R.,et al., 2018 [58]	A spatial 3 DOF 3 cables	–	No	1) A method to find a collision-free path between two points while adhering to the actuator's and joints' force capabilities 2) To compute collision-free path positions and velocities of two initial and final points
Pinto, A.M., et al., 2017 [68]	SPIDERobot 4 DOF	Pick and place in the industry	Yes	1) A new approach based on visually locating the position of the mechanism and obstacles to optimize the trajectory of the robot by visual interpretation of the workspace. 2) Collision avoidance between cables and the environment
Gagliardini, L., et al., 2018 [65]	IRT Jules Verne CAROCA project. 8 cables	–	Yes	1) Dividing the defined workspace into n parts (by predicting the collision between cables and objects in the workspace) which are represented by just one configuration. 3) For each configuration, defining the set of possible locations for attachment points by the designer 4) Generating many CDPM configurations by placing the attachment points on the possible locations 5) Configurations satisfying the constraints such as interference between cables and wrench feasibility are selected. 6) A combination of this configuration is needed to optimize presented objective functions to maximize productivity and minimize reconfiguration time.



*Table VII. (Continued)*

<b>Paper</b>	<b>DOF, cables</b>	<b>Application</b>	<b>Workspace</b>	<b>Points and Goal</b>
Xu, J. and K.-S. Park, 2021 [64]	6 DOF 8 cables	–	Yes	1) Using rapidly exploring random tree (RRT) method to address moving cube obstacle (A DJI Tello drone) avoidance. 2) Using the Gilbert–Johnson–Keerthi algorithm to detect collision.
Barbazza, L., et al., 2017 [61]	3 DOF 4 cables	pick and place process	Yes	1) Online reconfiguration of attachment points on the end effector to avoid collisions with obstacles and optimize trajectory.
Mishra, U.A., et al 2021 [62]	6 DOF 8 cables	cluttered environment	Yes	1) Detecting collision (between cable with end effector and end effector with obstacles) faster and more accurately by integration of GJK algorithm on sampling base
Xu, J. and K.-S. Park 2020 [60]	3 DOF 8 cables	–	Yes	1) Collision-free path planning 2) Collision avoidance in all cases: cable with cable, the cable with the end-effector, the cable with the obstacle 3) Using Rapidly exploring random tree (RRT), due to oscillation in the robot and difficulty to reach the goal (when it is applied on a dynamic environment) with artificial potential field (APF) method
Rousseau, T., C. et al 2022 [48]	CRAFT prototype, 8 cables	–	Yes	1) Guarantee the safety of users in collaborative CDPMs by defining a direct relationship between cable tensions and collision force. 2) Adaptive controller based on cable tension management (represented in the null space of wrench matrix) when there is a risk of collision.

**Table VIII.** *Impact of collision avoidance between cables and between cable and end effector on the CDPM/(R)CDPM.*

<b>Paper</b>	<b>DOF, cables</b>	<b>Application</b>	<b>Workspace</b>	<b>Points and Goal</b>
Meziane, R., et al. 2019 [66]	7 cables	Human-robot interaction	No	1) Altering end effector's trajectory due to cable collisions 2) Cables that are close to interference (determined by KKT conditions) can prevent collisions. The user can feel this force.
Makino, T. and T. Harada. 2016 [56]	6 DOF 8 cables	–	No	1) Modification of minimum distance between cables by rotation of end effector around z and rotation of the pulley 2) Collision between cables to improve small rotational workspace by the kinematic redundancy and second redundancy or actuation redundancy control the cables' tensions 3) Using kinematic redundancy due to cable collisions,
Bury, D., et al. 2019 [51]	CoGiRo.	–	No	1) Valid straight paths by checking collision, so the platform rotates or translates at a constant linear or angular velocity. 3) Comparison between the continuous method and with discretized one integrated with the Humanoid Path Planner (HPP) software.
Youssef, K. and M.J.-D. Otis 2020, [2]	3 DOF 8 cables	Human-robot interaction	Yes	1) Minimum distance detection of the two cables. 2) Cables with a higher position move up the attachment points to increase the distance between the two cables. 3) The trajectory of the end effector is unchanged.
Trautwein, F., et al. 2021 [63]	–	–	Yes	1) To avoid collision and track predefined trajectory by adaption of components positions. 2) Disconnecting one or more cables from their initial attachment points and connecting to newly relocated attachment points. 3) Computation of the position of new attachment points for all the configurations by an optimization algorithm and considering constraints selected by the designer. 4) Reduce computational time. 5) Needs the knowledge of the designer about trajectory to divide the workspace into n parts.
Rushton, M. and A. Khajepour, 2021 [67]	–	–	–	1) Changing the attachment points of cables when a collision is recognized along the length of a cable and causes changes in the dynamic structure of the mechanism. 2) One of the significant advantages of a Variable Structure Cable Robot (VSCM) is the ability to cover a non-convex workspace. 3) Moving obstacles is not discussed in this paper.

*Table VIII. (Continued)*

<b>Paper</b>	<b>DOF, cables</b>	<b>Application</b>	<b>Workspace</b>	<b>Points and Goal</b>
Ennaiem, F., et al., 2021 [59]	Reconfigurable 6-DoF 8 cables	Rehabilitation	No	1) Recording the gestures of five participants with a motion capture system to analyze the workspace of the mechanism. 2) Computation of the shortest distance between cables to avoid collision between cables 3) Positive angle between each cable and distance between attachment points on end effector and center of end effector to avoid collision between cables and end effector 3) To select the optimal structure for the mechanism the optimization function is performed by the PSO algorithm which can satisfy constraints such as collision. 4) The obtained solution presents the inconvenience of having an inappropriate size for the target application due to the large variation of prescribed rotation angles. 5) Due to the large variation of rotation angle, the smaller size is proposed by a nested algorithm and selects the optimal structure of the mechanism. Meanwhile, pulleys' locations according to end-effector pose
Martin, A., et al 2018 [69]	Prototype CAROCA with the COGIRO configuration	Large trusses	No	1) Using the software ARACHNIS to show the boundaries of the interference between the cables and a cylinder 2) Dividing the cylinder into three parts, (two endcaps and the other parts of the cylinder). 3) Connecting four points (the cable tangent to the cylinder on the interference region) by a straight segment along the cylinder, and two arcs along its endcaps depending on the position of the cable attachment points concerning the cylinder. 4) Presenting five zones correspond to a different arc segment which is considered to draw the boundaries of the interference region. 5) Considering orientation constant.
Carpio Aleman, M.A., et al. 2018 [53]	6 DOF 8 cables	Industry	No	1) Calculation of a) Determination of space trajectory to move and rotate from one point to another b) Trajectory segmentation c) Cable length calculation d) Tension calculation according to collision detection e) Using intervals of the centroid of the end effector to estimate displacement and orientation

Table VIII. (Continued)

Paper	DOF, cables	Application	Workspace	Points and Goal
Khoshbin E et al 2022 [47]	3 DOF 8 cables	Industry	Yes	1) Estimation of the shortest distance between human limbs and cables by KKT method 2) Changing the attachment position on the base when the shortest distance is lower than the threshold
Zou, Y., et al. 2022 [49]	Suspended CDPM 2 cables			1) A data-driven kinematic control scheme is developing to address the collision-free constraint 2) The scheme enables a CDPR to control its pose even if it suffers collisions between a cable and the base or end-effector 3) The control scheme uses a motion model based on data samples rather than the Jacobian matrix to map control laws in the task space. 4) Utilizing the time derivative of the length of cables in the joint space to deal with collisions
Hu, Y., et al. 2022 [50]	2 DOF	–	–	1) Limitation workspace and the position of attachment points due to the collision-free constraint of CDPMs 2) Modelling and control (A sliding mode-based controller) of a CDPM allowing cable-edge collisions by collision-free constraint.
Lesellier, M. and M. Gouttefarde. et al, 2019 [55]	CoGiRo 6 DOF 8 cables	No	No	1) The cable span is shown as the set of all cable positions for all the poses of the end effector in the predefined workspace. 2) No collision between the mechanism and the cable if the set of all possible motions of a mechanism onboard the end effector is fully outside of the cable span 3) Proposing the bounding volume (polyhedron) approximation of the cable span due to the geometric object complexity of the cable span
Bak, J.-H., et al., 2019 [52]	6 DOF 8 cables	Cluttered environment	Yes	A modified goal-biased RRT algorithm and GJK algorithm to find the distance between the robot and fixed objects and solve the cable collision problem.
Makino, T. and T. Harada. 2016 [56]	6 DOF 8 cables			1) Design a CDPM using a rotational mechanism inside the end effector. 2) Control of cables by rotating the end effector around the vertical axis to change the configurations of the cables, when a collision among cables is detected.
Fabritius, M., et al. 2019 [54]	IPAnema 3 platform	–	Yes	1) Novel method for approximating the end effector collision-free total orientation workspace with different end effector orientation sets. 2) Utilizing a convex collision cone data structure for efficient and accurate collision detection from the end effector geometry data. 3) Attachment point locations on the end effector can be easily altered, while the platform geometry is constrained by application-specific design requirements.

### 3.2.4. Singularity

Singularity is a point in the robot's workspace where it loses one DOF and reduces the accuracy of the CDPM. Table IX presents the impact of singularity on CDPM performance.

### 3.2.5. Reconfiguration CDPM

Moving the attachment points on the base or altering the cable-pulley rotation, as prescribed by the reconfiguration theory, provides a superior solution compared to maintaining fixed attachment points. This approach involves modifying the geometric configuration of the (R)CDPM to update their constraints; however, it also results in an increased complexity of the process. The (R)CDPM has been proposed for applications in cluttered environments or where multiple end effectors are required. Table X shows several studies on the reconfiguration of CDPM. Kumar, Rajesh, and Sudipto Mukherjee 2021 [79] present the optimization of attachment points position based on rigid body dynamics of multiple contact problems to reduce cable slackening and the emergence of singularity poses.

## 3.3. Suggested methodology for (R)CDPM design and control

On the one hand, in the industry and assembly process, the robot must repeat the repetitive process and track the desired trajectory that is introduced to the robot. The physical uncertainties in the mechanism due to the properties of cables, such as sagging, wrapping, creep, and other properties such as unstable payload and singularity, affect the performance of the robot in tracking the trajectory when the robot and human are collaborating. In the pick-and-place processes, there are several control methods for CDPM as follows: cartesian position/velocity control such as 1-cable length control, cartesian position (outer loop) to articular cable length (inner loop), 2-cable tensile control, cartesian position to articular force and cartesian wrench control such as 3-cable length control: cartesian wrench to articular cable length control, 4-cable tensile control: cartesian wrench to articular force control. Articular control with a tensile cable force is proposed by Otis et al. 2009 [133] as a set point to adjust the Cartesian pose of the end-effector. Vision-based and model-based controls are used to improve the performance of the tracking trajectory by the end effector. A precise robot model is not required because the pose of the end effector can be estimated directly in Cartesian space. However, in vision-based control, precise measurement of the end-effector pose is achieved using external sensors such as cameras and motion capture systems to mitigate the influence of cable properties such as sagging and stretching. This approach estimates the positions of objects using visual data from a camera mounted on the end effector, rather than relying on a forward kinematics problem [134]. Predicting exact uncertainties in a complex CDPM is impractical. Therefore, utilizing visual data is advised, with two configurations: (1) eye-to-hand configuration, achieved by observing the robot with a stationary camera in the environment and (2) eye-in-hand configuration, where the camera on the end effector observes the target object (payload) in the environment. In vision-based control, the effectiveness of CDPM is highly dependent on the quality of the camera. The precision, resolution, and sensitivity of the sensors are essential for improving pose estimation, although this results in higher costs. Transitioning from model-based to vision-based control can improve the accuracy of CDPMs.

By contrast, reconfiguration is used to avoid collisions between cables [2] or between humans and cables [47]. In addition, designing reconfigurable CPDMs, (R)CDPM, to avoid collisions between cables or between humans and cables and choosing the optimal controller for the mechanism to track the desired pose is a challenge. A controller can improve the performance of the (R)CDPM to track the trajectory; however, constraints such as positive tension in cables may limit the performance of the CDPM. Designing a robust controller in the presence of uncertainty due to the physical properties of the CDPM is recommended.

There are several conventional model-based controllers such as PID [135], sliding mode [136], and prediction control [137]. These controllers are developed for both the task and joint spaces to

**Table IX.** *Impact of singularity on the CDPM/(R)CDPM.*

<b>Paper</b>	<b>DOF, cable</b>	<b>Workspace</b>	<b>Calibration</b>	<b>Preserved trajectory</b>	<b>Points, Goals</b>
Diao, X., O. Ma, and Q. Lu.2008 [131]	Planar 3 DOF n cables	No	No	No	1) Analyzing two singularities: The Jacobian singularity and the force-closure singularity. 2) A Jacobian singularity occurs when the Jacobian matrix of CDPM is not full rank. 3) Then due to the inability of cables to generate tension which causes force-closure singularities.
Merlet, J.-P. 2019 [14]	1) IK parallel mechanism singularity: a 6-cable CDPM 2) IK full singularity: mechanism MARIONET-CRANE as a suspended CDPM with 6 cables	Yes	No	–	1) Different singularity by considering sagging in the Irvine model and indicating inverse and forward kinematics 2) The matrix Jacobian IK may be singular in three cases: • IK Irvine singularity • IK parallel robot singularity • IK full singularity 3) IK singularity is located on the border of the workspace. 4) Both the IK and FK have also full singularities (different than parallel robot singularity) and are performed when two of the IK or FK solution branches intersect.
Zi, B., et al., 2012 [46]	Three translational DOFs	Yes	No	Yes	1) Presenting kinematics and graphical representation of the singularity configuration of a hybrid-driven cable-suspended parallel robot. 2) Presenting inverse kinematics by closed-loop vector conditions and geometric methodology. 3) Singularity condition calculation by analytical methodology and gradual search algorithm while the workspace is defined based on a Jacobian matrix.

*Table IX. (Continued)*

<b>Paper</b>	<b>DOF, cable</b>	<b>Workspace</b>	<b>Calibration</b>	<b>Preserved trajectory</b>	<b>Points, Goals</b>
Briot, S. and J.-P. Merlet, 2023 [4]	Planar 3 DOF 3 cables	No	No	No	1) Present the computation of the geometric–static model based on Irvine’s model by considering sagging in cables 2) Discussion of stability analysis.
Babaghasabha, R., et al 2016 [44]	Planar 3 DOF 4 cables	No	No	Yes	1) Adaptive robust control scheme that utilizes elastic cables to manage the longitudinal vibrations of such cables, even in the presence of uncertainties in parametric and structural aspects. 2) Modelling the dynamics of the cables as a linear axial spring model.
Diao, X. 2015 [45]	6-DOF 7 cables	No	No	–	1) Presenting the Jacobian singularity and the force-closure singularity by mathematical proof 2) In the full rank Jacobian matrix, the cables are not able to generate tension causing force-closure singularities
Xiang, Y., Q. Li, and X. Jiang 2021 [43]	3-DOF rotational 4 cables	No	No	No	1) Presenting a scheme for the dynamic planning of trajectories with a rigid link. 2) Analyzing the kinematics, dynamics, and actuation singularity loci of the CDPR 3) The singularity loci partition the workspace into four distinct parts, which ultimately restrict the performance of the mechanism’s motion. 4) The study examines consistency conditions that enable the robot to traverse singular orientations stably. 5) To simplify the identification of necessary conditions for complex parallel robots, a vector inner product form of consistency conditions is derived. 6) Planning dynamic trajectories using a unit quaternion to achieve a sequence of desired orientations 7) A trajectory without singular orientation is generated using a modified spherical linear interpolation with a fifth-degree polynomial. To satisfy consistency conditions and pass through singular orientations, a transition segment is designed using a seventh-degree polynomial that merges into the fifth-degree polynomial.

**Table X.** *Impact of cable sagging due to mass and elasticity on the CDPM/(R)CDPM.*

<b>Paper</b>	<b>DOF cable</b>	<b>Workspace</b>	<b>Calibration</b>	<b>Preserved trajectory</b>	<b>Points, Goals</b>
Mishra, U.A. et al, 2021 [62]	6 DOF 8 cables	No	No	No	1) Optimizing cable routing for (R)CDPMs. In some other reconfiguration methods, the methodology of connecting winch drums to the attachment points in reconfiguration has not been discussed. 2) By considering constraints the objective function can be found. Some constraints are introduced to find a good cable routing configuration. a) Structural Constraints b) Pulley Constraints c) Collision Constraints in two situations when the end effector moves inside a lattice and outside the lattice.
Gagliardini, L., et al., 2015 [132]	A 4-cable suspended planar.	No	No	Yes	1) Changing attachment points location on the base with a Dijkstra's based algorithm. 2) Optimal configurations obtained by a graph-based approach concerning some criteria such as the mechanism stiffness and end effector positioning error.
Gagliardini, L., et al., 2016 [73]	6 cables	No	No	Yes	1) Finding attachment points location on the base according to required task constraints by a graph-based formulation. 2) Minimizing the number of reconfigurations to find cable layouts for reconfiguration Cable-Driven Parallel Mechanism.
Gagliardini, L., et al. 2015 [72]	CAROcA 6 DOF 8 cables	No	No	No	1) Reconfigurability is required to avoid cable collisions. 2) (R)CDPM to adapt their constraints can modify their geometric parameters 3) Disconnecting cables from their current attachment points and moving to a new location. 4) Determining the optimal locations of the cable attachment point 5) Minimizing the robot's overall size 6) This paper is very time-consuming.



*Table X. (Continued)*

<b>Paper</b>	<b>DOF cable</b>	<b>Workspace</b>	<b>Calibration</b>	<b>Preserved trajectory</b>	<b>Points, Goals</b>
Gagliardini, L. et al, 2018 [65]	3 DOF 8 cables	No	No	Yes	<p>1) Changing the position attachment points on the base on a predefined grid. 2) Introducing the cost function to minimize the tension in cables by considering constraints such as:</p> <ul style="list-style-type: none"> <li>• Cable Interferences</li> <li>• Collisions between the Cables and the environment</li> <li>• Wrench Feasibility</li> <li>• Cable Lengths.</li> </ul> <p>3) Dividing the predefined trajectory into parts according to designer experience. 4) Comparison between the configurations that satisfy the constraints and finding the combinations of configurations that perform their task by optimizing some objective function(s). 5) Introducing objective function to Minimize the number of cable attachments, minimizing the size of the (R)CDPR. 6) Nineteen hours' computation.</p>
Tourajizadeh, H. and M.H. Korayem, 2016 [88]	6 DOF 6 cables	No	No	No	Deriving the orientation of the end effector to prevent cable interference
Anson, M., et al 2017 [89]	3 DOF 4 cables Planar	Yes	No	Yes	2) Wrench closure workspace analysis due to reconfiguration 3) No study is conducted on cable interference avoidance. 4) Position control to track trajectory
Ismail, M. et al. 2016 [87]	2 DOF 2 cables	No	No	Yes	1) Hybrid cable–serial mechanism. 2) Using a controller decouple and linearize the dynamic of the hybrid cable–serial mechanism. 3) Generating the shortest path between two poses of mechanism to reach the goal while avoiding collision with obstacles.
Bordalba, R.,et al 2018 [58]	3 DOF	No	No	No	1) Validated for specific architectures only. 2) Using a recent randomized kinodynamic (planning technique) to generate a dynamic trajectory. 3) The returned trajectory is smoother in position not in velocity and acceleration.

*Table X. (Continued)*

<b>Paper</b>	<b>DOF cable</b>	<b>Workspace</b>	<b>Calibration</b>	<b>Preserved trajectory</b>	<b>Points, Goals</b>
Makino, T. and T.Hara a. 2016 [56]	6 DOF 8 cables	No	No	No	1) Two redundancies, namely kinematic redundancy to prevent cable collisions and actuation redundancy to regulate cable tension. 2) Altering the end effector orientation to avoid cable collisions. 3) No proposed solutions to address the mechanical limit of the rotating pulley
Abbasnejad, G. and M. Tale Masome,2020 [80]	6 DOF 7 cables	Yes	No	Yes	1) Improving orientation workspace by changing attachment points on base according to the position of the end effector on trajectory. 2) For a prescribed range of orientation, a spherical zone is determined, and the optimal configuration of the mechanism can be defined by changing the position of the attachment points on the base. 3) Using Particle Swarm Optimization to find optimal actuation 4) Improvement in the performance of this method compared to the CDPM with fixed cable attachment points on the base.
Khoshbin E, et al, 2022 [47]	3 DOF 8 Cables	Yes	No	Yes	1) Estimation of the shortest distance between cable and human by KKT method 2) Collision avoidance between cable and human when the distance between cable and human is lower than tolerance 3) Reconfiguration by changing the position of attachment points on the base to avoid collision between cable and human
Youssef Kh, et al, 2020 [2]	3 DOF 8 Cables	Yes	No	Yes	1) Estimation of the shortest distance between cables 2) Collision avoidance between cables when the distance between cables is lower than the tolerance 3) Reconfiguration by relocation of the attachment points on the base (higher cables) to avoid collision between cables
Wang, B., et al. 2016 [57]	Planar RCDPM	Collision Free Force Closure Workspace (CFFCW)	No		1) Positioning end effector in free collision path by considering constraint (Finding Workspace without collision between end effector and obstacles) 2)Moving attachment points fixed on a block linear or cyclic motion 3)Merging obstacles in the environment between two cables in one convex. 4)Determination of the range of motion in cables to obtain the force-closure constraint.

Table X. (Continued)

Paper	DOF cable	Workspace	Calibration	Preserved trajectory	Points, Goals
Raman, A., et al., 2020 [84]	3-PRP planar	Yes	No	Yes	1) The feasibility of the mechanism is defined to achieve stiffness modulation to enhance disturbance-rejection. Task-space stiffness modulation is recognized by coordinating: (i) joint stiffness; (ii) net-zero antagonistic cable tensions; and (iii) system configuration. 2) Establishing the initial feasibility of the approach through the optimization-based planning effort
Raman, A., et al., 2022 [76]	4 cables	No	No	Yes	1) Developing a fault-tolerant control scheme for automatic task recovery by combining an online failure detection framework with a pose estimation with redundancy resolution. 2) End-effector information is used to detect failures through an Interactive Multiple Model (IMM) algorithm.
Chen, T., et al. 2017 [74]	6 DOF 6 cables	Yes	No	–	1) Smoothly change DOFs and improvement of working efficiency 2) Analyzing the kinematics characteristics of the rotating guide-bar mechanism 3) Study the relation between the trajectory of the rotating guide-bar mechanism and the workspace
Abbasnejad, G. and M. Tale-Masouleh, 2021 [80]	6 DOF 7 cables	Yes	No	Yes	1) Computing the optimal actuation based on PSO (Particle Swarm Optimization) by changing attachment points on the base According to the end-effector trajectory. 2) Improving the torque exertion ability and orientation workspace 3) Defining the spherical zone to satisfy the wrench-closure condition for a prescribed range of orientation, and optimal robot configuration is determined by considering the volume of this zone. 4) The moving attachment points on the robot's base are modified to find the best configuration and actuation plans are calculated to ensure that the external wrench is balanced by cable tension as the end-effector moves on its trajectory..
Trautwein, F., et al. 2021, [63]		Yes	No	Yes	1) The objective is to prevent collision and follow a predetermined trajectory by adjusting the positions of components. 2) This involves detaching one or multiple cables from their original attachment points and connecting them to new attachment points in different locations. 3) An optimization algorithm is used to calculate the positions of the new attachment points for all configurations while taking into account constraints specified by the designer. 4) The aim is to minimize computational time.

*Table X. (Continued)*

<b>Paper</b>	<b>DOF cable</b>	<b>Workspace</b>	<b>Calibration</b>	<b>Preserved trajectory</b>	<b>Points, Goals</b>
Boumann, R. and T.Bruckmann. 2021 [81]		Yes	No		1) Using movable pulleys on actuated linear slides to minimize kinetic energy and avoid collisions 2) To devise an emergency strategy to explore the issue of cable failure in reconfigurable CDPM 3) Presenting static equilibrium workspace of the platform with a constant orientation before and after failure.
Barbazza, L., et al 2017 [61]	3 DOF 4 cables	Yes	No	No	1) Online reconfiguration of attachment points on the end effector to avoid collisions with obstacles. 2) The algorithm can be defined to optimize trajectory.
Wang, X., et al. 2022 [78]		Yes	No	No	1) The improved Soft AC algorithm incorporates expected SARSA and adaptive target values to enhance sample utilization. 2) Highlighting the potential of deep reinforcement learning and the improved Soft AC algorithm for obstacle avoidance tasks in RCDPM.
Carpio Alemán, M.A., et al, 2019 [85]	3 DOF 4 cables	Yes	No	No	1) The expansion of the orientation Wrench Feasible Workspace 2) Automatic mobility of two attachment points on the end effector in the Circular-geometry effector mechanism 3) Comparison of traditional fix attachment robot with a rectangular geometry 4) Identification of generated workspace volume in an analysis-by-intervals by considering the feasible geometric and tension forces on the cables
Muntashir, R. and L. Nurahmi. 2022 [77]	3 cables	No	No	Yes	1) Reconfiguration with three mobile bases 2) Using a fifth-degree polynomial to generate the desired end-effector trajectory 3) Analyzing the robot's dynamic equilibrium 4) Utilizing the concept of Zero Moment Point to maintain stability during mobile base reconfiguration. 5) Demonstration of the significant impact of reconfiguration on robot stability and the reduction of cable tension.

*Table X. (Continued)*

<b>Paper</b>	<b>DOF cable</b>	<b>Workspace</b>	<b>Calibration</b>	<b>Preserved trajectory</b>	<b>Points, Goals</b>
Ennaïem, F., et al.,2021 [59]	6 DOF 8 cables	Yes	No	No	1) The workspace of a mechanism is analyzed by recording the gestures of five participants using a motion capture system. 2) To prevent collisions between cables, the shortest distance between them is calculated. 3) To avoid collisions between cables and the end effector, a positive angle is maintained between each cable and the distance between the attachment points on the end effector and the center of the end effector is considered. 4) The optimal structure for the mechanism is selected using a PSO algorithm to perform an optimization function that satisfies constraints such as collision avoidance.
Wang, X., et al.. 2023 [70]	3 DOF	Yes	No	No	1) Developing a new 3-DOF point-mass reconfigurable CDPM by adjusting the positions of multiple attachment points. 2) Wrench feasible workspace (WFW) is a crucial criterion that describes the configuration characteristics of the RCDPM 3) An optimal reconfiguration planning method has been proposed to schedule the sequence and number of movable cable anchors to adjust the WFW range. 4) The method enables static reconfiguration (SR) or dynamic reconfiguration (DR) of the RCDPR, depending on the required WFW. 5) The optimization process uses L1-norm optimization to minimize the number of movable cable anchors in DR, which can save actuator energy and ensure physical constraints are met.

Table X. (Continued)

Paper	DOF cable	Workspace	Calibration	Preserved trajectory	Points, Goals
Xiong, H., et al., 2022 [75]	6 DOF 7Cables	No	No		1) Introducing an inherent problem as reconfiguration planning in RCDPM by moving four attachment points. 2) Using a reconfiguration value function as a reference index for planning the reconfiguration of an RCDPM. 3) Improve the control performance by integrating reconfiguration planning and dynamic control. 4) Presenting the efficiency of the method by reducing the reconfiguration planning time (more than 93%)
Wang, H., et al 2019 [86]	6 DOF 8 cables	No	Yes	Yes	1) Presenting four categories for cable outlet mechanism on base: the eyelet, single-pulley, double-pulley, and multi-pulley types. The eyelet type is ideal where the cable outlet point is fixed, 2) Using pulley as RRP kinematic (spatial) or RP kinematic (planar) because of Friction, cable breakage, and reduced accuracy which are several issues in the system due to the relative motion between the cable and eyelet.
Zhao, T., et al., 2019 [83]	6 DOF 6 cables	No	No	Yes	1) Modular reconfigurable as several different configurations by 6 identical modular branches 2) Design this mechanism by changing the attachment points on the end-effector to find diverse task requirements. 3) The MRCPR transformed from a 6-DOF configuration to 4, 3, or 2 DOF by detaching its modular branches. 4) Presenting the inverse kinematics and dynamics of the MRCPR using the vector closed rule and Lagrange method, respectively, while considering varying configurations including 2, 3, 4, and 6 DOF.
Rodriguez-Barroso, A.et al. 2018 [82]	N DOF N + 1 Cables	No	Yes	No	1) Design CDPM with a reconfigurable end effector using a compliant actuator actuated by one motor applying force on both parts of the end effector. 2) Measuring the position of the reconfigurable end effector and cable tension in each region of the compliant actuator. 3) Presenting an elastic model to solve the finest static and wrench analysis due to the high tension in the cables of this mechanism.

enhance tracking of the desired position of the end effector. Aflakiyan et al. 2015 [138] presented the Ziegler–Nichols method to estimate the parameters of the PD controller, ensuring stability with state feedback and PD, while the dynamic pulley is considered in the equation of the mechanism.

The wave-based controller can move the position of the end effector in the presence of uncertainty, without requiring precise calibration or installation. It can also effectively dampen the vibrations within the system. The effectiveness of wave-based controllers in vibration rejection stems from their capability to propagate and manipulate waves along a structure to counteract these vibrations [139]. Khalilpour et al. 2019 [140] introduced models for actuator and power transmission systems by employing cascade control in uncertain conditions. The inner loop regulates the tensile forces in the cables and requires tension sensors. The outer loop uses a robust sliding-mode controller to follow the desired position. A sliding mode controller in Cartesian space for a 6-degree-of-freedom (6 DOF) CDPM is introduced, relying on cable length sensors (motor encoders within the reel) [136]. The challenge with this controller is chattering, which is a phenomenon in which the control signal rapidly switches between two values. Several approaches have been proposed to mitigate this issue in sliding mode controllers. To ensure stability, a novel approach is suggested based on the Lyapunov theory proposed by Khalilpour et al. 2018 [141]. The authors proposed a method for controlling CDPMs in Cartesian coordinates without calibration. They considered uncertainties in parameters, such as attachment points, and analyzed the stability of the closed-loop system using the Lyapunov matrix. Sancak et al 2022 [142] improved the tracking of the desired trajectory of the end effector using the reinforcement learning (RL) method. Tho & Think 2021 [8] predicted sagging in cables using ANFIS. Kumar et al 2019 [143] employed input–output feedback linearization using the pole placement technique to achieve the desired end-effector position. This linearization method is designed for a specific type of nonlinear system by altering a suitable coordinate and applying a linearizing state feedback. The effectiveness of the controller is demonstrated in the presence of noise. Kiani et al. 2017 [144] present a model reference adaptive controller to reject external disturbances or vibrations in the end effector. The adaptive fuzzy sliding mode control presented by Aghaseyedabdollah et al. 2022 [145] is proposed to tune the gain of the PID sliding surface and reduce chattering and payload disturbances. However, there are many papers about design controllers for CDPM; to the best of our knowledge, there is a gap in design controllers for reconfigurable CDPM when the kinematic, dynamic, and Jacobian matrices of the mechanism are changing because of moving attachment points on the base. Designing a robust controller in the presence of uncertainty due to the physical properties of the cable-driven parallel is recommended. The parameters of the controller can be tuned in real time to achieve a higher performance.

Figure 6 presents the steps for designing a Cartesian end-effector controller for the (R)CDPM. Given the physical challenges posed by the mechanism, there are uncertainties in the dynamics of the RCDPM due to changes in the kinematic or attachment-point position on the base. We recommend the use of a robust controller in future work to achieve high stability in human–robot collaboration.

Figure 7 presents the control architecture for the (R)CDPM using human–robot collaboration. In the proposed architecture for 6 DOF CDPM with eight cables, several constraints can be modified by geometrical modification or reconfiguration; however, we focus on reconfiguration theory to avoid collisions between cables or between cables and humans by the relocation of attachment points on the base. The Cartesian control law is proposed to generate the desired velocity as a reference signal for the predictor velocity controller to generate the desired tension for each motor.

An adaptive generalized prediction controller is proposed for several key reasons. The goal of the GPC compensator is to generate a tensile force to minimize the tracking trajectory error and disturbance rejection. First, this controller is capable of modeling the linear CDPM and can estimate the parameters of the linear transfer function of the system, even in the presence of uncertainty in the dynamics of the CDPM and changing attachment points on the base. For the adaptive component, the recursive least squares (RLS) algorithm is employed to estimate the parameters of the transfer function of the CDPM dynamics, which are variable due to the changing dynamics of the mechanism. The estimated CDPM model is utilized to design a predictor and an optimizer, which served as the two components of a predictive controller. From the RLS, an update of the controller parameters is achieved based on

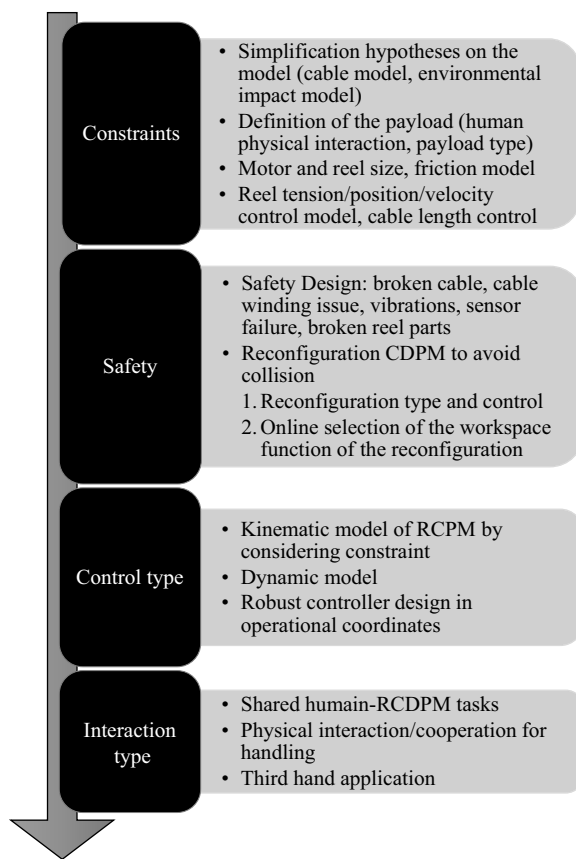

*Figure 6. RCDPM controller design steps.*

these newly estimated parameters. Second, this controller integrates a tension distribution algorithm directly into the controller to compute the cable tensions [146]. In another type of controller, the desired wrench is computed, and tension is applied to the system using the tension distribution method [147]. Meanwhile, in the optimization equations, the constraints in the control input (limitation in the positive and maximum cable tensile forces) and output are considered. Subsequently, a cable tension controller is used to reduce the tension error between the desired tension generated by the predictor controller and the current measured tension. Moreover, a reconfiguration controller is proposed to adapt the geometry and move the attachment points on the base to avoid collisions between humans and cables.

Some control options can be added, namely, a stability observer and safety validation. A stability observer is useful for analyzing the stability of the controller architecture, including human impact.

A safety validation to guarantee safety is presented in ref. [148]. The functions shown in Figure 7 are presented in Table XI.

#### 4. Conclusion and future work

Several parameters can be introduced as constraints that can affect the performance of the CDPM. In the first part of this paper, the physical parameters of the CDPM are discussed; in the second part, physical constraints such as singularity, cable sagging, unstable payload, cable wrapping, and collision avoidance in the modeling of the CDPM are considered to improve the system performance. Different reconfiguration methods to avoid collisions between cables or between cables and humans are discussed



**Table XI.** Functions in closed-loop control block diagrams.

Function	Reference
Prediction controller	[137]
Human model	[149]
Human pose prediction	[150]
Motor	[151]
Attachment points relocation for reconfiguration control	[47]
Optimal Tension Distribution	[152]
Stability Observer	[149]
Intern model	[153]
Safety validation	[148]
Workspace boundary evaluation	[2, 47]
Collision avoidance	[2, 47]

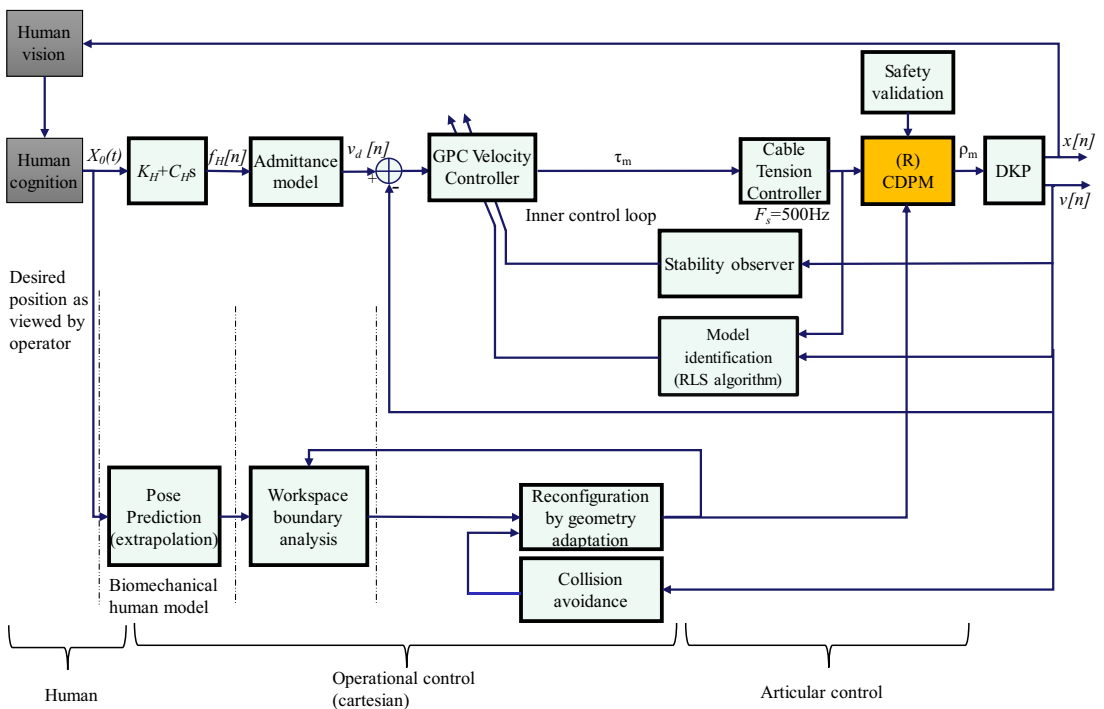

**Figure 7.** Suggested control architecture for (R)CDPM using human-robot collaboration.

to improve the performance of the CDPM. A total of 88 papers are reviewed to find all the constraints to be considered in the design step suggested in this paper.

In human–robot collaboration applications such as picking, placing, or assembly/disassembly processes, the end effector needs to track the desired trajectory.

In future work, design controllers besides reconfiguration theory can improve the performance of CDPM in human–robot collaboration for the assembly/disassembly process. The reconfiguration guarantees human safety and avoids collisions between cables or cables and humans, whereas the controller aims at the end effector to track the desired trajectory in the assembly process.

A controller is proposed to improve the precision of the end effector in the presence of constraints such as sagging, wrapping, creep, unstable payload, and singularity. This is because the reconfiguration theory changes both the kinematic and dynamic models of the CDPM.

**Author contributions.** EK, MO, and RM contributed in developing the study concept. EK performed the initial manuscript, while MO and RM provided supervision. All authors participated in reviewing, revising, and approving the final version of the manuscript.

**Financial support.** This work received financial support from the Fonds de recherche du Quebec – Nature et technologies (FRQNT) under grant numbers 2020-CO-275043 and 2016-PR-188869. This project uses the infrastructure obtained by the Ministère de l'Économie et de l'Innovation (MEI) du Quebec, John R. Evans Leaders Fund of the Canadian Foundation for Innovation (CFI), and the Infrastructure Operating Fund (FEI) under the project number 35,395. Other financial support was also used in this project. Natural Sciences and Engineering Research Council of Canada (NSERC) Discovery Grant number RGPIN-2018-0632.

**Competing interests.** The authors declare that they have no competing interests.

**Availability of data and materials.** Not applicable.

**Ethics approval and consent to participate.** Not applicable.

## References

- [1] S. Caro and J.-P. Merlet, "Failure Analysis of a Collaborative 4-1 Cable-Driven Parallel Robot," *In: New Trends in Mechanism and Machine Science: EuCoMeS. 8*, (Springer, 2020).
- [2] K. Youssef and M. J.-D. Otis, "Reconfigurable fully constrained cable driven parallel mechanism for avoiding interference between cables," *Mech Mach Theory* **148**, 103781 (2020).
- [3] V. Phillips and E. Barker, "Systematic reviews: Structure, form and content," *J Perioper Pract* **31**(9), 349–353 (2021).
- [4] S. Briot and J.-P. Merlet, "Direct kinematic singularities and stability analysis of sagging cable-driven parallel robots," *IEEE Trans Robot* **39**(3), 2240–2254 (2023).
- [5] T. P. Tho and N. T. Thinh, "Sagging cable analysis and evaluation of 4-degree-of-freedom cable robot using adaptive neural fuzzy algorithm," *Int J Mech Eng Robot Res* **11**(2), 73–78 (2022).
- [6] J.-P. Merlet and R. Tissot, "A Panorama of Methods for Dealing with Sagging Cables in Cable-Driven Parallel Robots," *In: Advances in Robot Kinematics* (Springer, Cham, 2022) pp. 122–130.
- [7] I. B. Yahia, J.-P. Merlet and Y. Papegay, "Mixing Neural Networks and the Newton Method for the Kinematics of Simple Cable-Driven Parallel Robots with Sagging Cables," *In: 20th International Conference on Advanced Robotics (ICAR)*, (2021) pp. 241–246.
- [8] T. P. Tho and N. T. Thinh, "Analysis and evaluation of CDPR cable sagging based on ANFIS," *Math Probl Eng* **2021**, 1–20 (2021).
- [9] J.-P. Merlet, "Efficient Kinematics of a 2-1 and 3-1 CDPR with Non-Elastic Sagging Cables," *In: 5th International Conference on Cable-Driven Parallel Robots*, (Springer International Publishing, 2021) pp. 3–12.
- [10] J.-P. Merlet, "The Forward Kinematics of the 4-1 Cable-Driven Parallel Robot with Non Elastic Sagging Cables," *In: Advances in Robot Kinematics* (Springer, 2021) pp. 98–108.
- [11] M. Fabritius and A. Pott, "A Forward Kinematic Code for Cable-Driven Parallel Robots Considering Cable Sagging and Pulleys," *In: Advances in Robot Kinematics* (Springer, 2020) pp. 218–225.
- [12] P. Gia Luan and N. T. Thinh, "Empirical quasi-static and inverse kinematics of cable-driven parallel manipulators including presence of sagging," *Appl Sci* **10**(15), 5318 (2020).
- [13] M. Fabritius and A. Pott, "An Inverse Kinematic Code for Cable-Driven Parallel Robots Considering Cable Sagging and Pulleys," *In: New Trends in Mechanism and Machine Science: EuCoMeS*, (Springer, 2020) pp. 423–431.
- [14] J.-P. Merlet, "Singularity of Cable-Driven Parallel Robot with Sagging Cables: Preliminary Investigation," *In: International Conference on Robotics and Automation (ICRA)*, (2019) pp. 504–509.
- [15] J.-P. Merlet, "Computing Cross-Sections of the Workspace of a Cable-Driven Parallel Robot with 6 Sagging Cables Having Limited Lengths," *In: Advances in Robot Kinematics 2018*, (Springer, 2019) pp. 392–400.
- [16] J.-P. Merlet, "Computing Cross-Sections of the Workspace of Suspended Cable-Driven Parallel Robot with Sagging Cables Having Tension Limitations," *In: IEEE/RSJ International Conference on Intelligent Robots and Systems (IROS)*, (2018) pp. 5042–5047.
- [17] J.-P. Merlet, "Direct Kinematics of CDPR with Extra Cable Orientation Sensors: The 2 and 3 Cables Case with Perfect Measurement and Sagging Cables," *In: IEEE/RSJ International Conference on Intelligent Robots and Systems (IROS)*, (2017) pp. 6973–6978.

- [18] M. Korayem, M. Yousefzadeh and S. Susany, "Dynamic modeling and feedback linearization control of wheeled mobile cable-driven parallel robot considering cable sag," *Arab J Sci Eng* **42**(11), 4779–4788 (2017).
- [19] P. Liu and H. Ma, "On the Stability for a Cable-Driven Parallel Robot while Considering the Cable Sag Effects," **In: 13th International Conference on Ubiquitous Robots and Ambient Intelligence (URAI)**, (2016) pp. 538–543.
- [20] T. K. Mamidi and S. Bandyopadhyay, "Forward dynamic analyses of cable-driven parallel robots with constant input with applications to their kinetostatic problems," *Mech Mach Theory* **163**, 104381 (2021).
- [21] I. Chawla, P. M. Pathak, L. Notash, A. K. Samantaray, Q. Li and U. K. Sharma, "Effect of selection criterion on the kinetostatic solution of a redundant cable-driven parallel robot considering cable mass and elasticity," *Mech Mach Theory* **156**, 104175 (2021).
- [22] T. P. Tho and N. T. Thinh, "Using a cable-driven parallel robot with applications in 3D concrete printing," *Appl Sci* **11**(2), 563 (2021).
- [23] J.-P. Merlet, "Some properties of the Irvine cable model and their use for the kinematic analysis of cable-driven parallel robots," *Mech Mach Theory* **135**, 271–280 (2019).
- [24] H. Hussein, M. Gouttefarde and F. Pierrot, "Static Modeling of Sagging Cables with Flexural Rigidity and Shear Forces," **In: Advances in Robot Kinematics**, (Springer, 2019) pp. 310–318.
- [25] E. Ottaviano, A. Anrea, V. Gattulli and F. Potenza, "Slackening Effects in 2D Exact Positioning in Cable-Driven Parallel Manipulators," **In: Cable-Driven Parallel Robots: Proceedings of the 4th International Conference on Cable-Driven Parallel Robots**, (Springer, 2019) pp. 4.
- [26] H. Yuan, E. Courteille, M. Gouttefarde and P.-E. Hervé, "Vibration analysis of cable-driven parallel robots based on the dynamic stiffness matrix method," *J Sound Vib* **394**, 527–544 (2017).
- [27] P. Liu and Y. Qiu, "Tension optimization for a cable-driven parallel robot with non-negligible cable mass," *Open Autom Cont Syst J* **7**(1), 1973–1980 (2015).
- [28] J.-P. Merlet, "The Kinematics of Cable-Driven Parallel Robots with Sagging Cables: Preliminary Results," **In: IEEE International Conference on Robotics and Automation (ICRA)**, (IEEE, 2015) pp. 1593–1598.
- [29] J.-P. Merlet, "On the Workspace of Suspended Cable-Driven Parallel Robots," **In: IEEE International Conference on Robotics and Automation (ICRA)**, (2016) pp. 841–846.
- [30] H. Yuan, E. Courteille and D. Deblaise, "Force distribution with pose-dependent force boundaries for redundantly actuated cable-driven parallel robots," *J Mech Robot* **8**(4), 041004 (2016).
- [31] J.-P. Merlet, "An Experimental Investigation of Extra Measurements for Solving the Direct Kinematics of Cable-Driven Parallel Robots," **In: IEEE International Conference on Robotics and Automation (ICRA)**, (IEEE, 2018) pp. 6947–6952.
- [32] C. Sun, H. Gao, Z. Liu, S. Xiang, H. Yu, N. Li and Z. Deng, "Design of spatial adaptive cable-driven parallel robots with an unlimited rotation axis using the cable wrapping phenomenon," *Mech Mach Theory* **171**, 104720 (2022).
- [33] C. Sun, H. Gao, Z. Liu, S. Xiang, H. Yu, N. Li and Z. Deng, "Design and optimization of three-degree-of-freedom planar adaptive cable-driven parallel robots using the cable wrapping phenomenon," *Mech Mach Theory* **166**, 104475 (2021).
- [34] M. C. Lei, "Dynamics of Cable Driven Parallel Manipulator Allowing Cable Wrapping Over Rigid Link," **In: IEEE/ASME International Conference on Advanced Intelligent Mechatronics (AIM)**, (IEEE, 2020) pp. 215–221.
- [35] M. C. Lei and D. Oetomo, "Cable wrapping phenomenon in cable-driven parallel manipulators," *J Robot Mechatron* **28**(3), 386–396 (2016).
- [36] M. C. Lei and D. Oetomo, "Kinematic modelling of cable wrapping on rigid-link phenomenon in cable-driven parallel manipulators," **In: AIM** (2015) pp. 97–103.
- [37] J.-M. Heo, S.-H. Choi and K.-S. Park, "Workspace analysis of a 6-DOF cable-driven parallel robot considering pulley bearing friction under ultra-high acceleration," *Microsyst Technol* **23**(7), 2615–2627 (2017).
- [38] D.-V. N. Kieu and S.-C. Huang, "Dynamic Creep Phenomenon on Polymer Cable with Non-linear Characteristics for Cable-driven Parallel Robots," **In: IEEE Eurasia Conference on IOT, Communication and Engineering (ECICE)**, (IEEE, 2020) pp. 378–380.
- [39] J. Piao, X. Jin, E. Choi, J. O. Park, C. S. Kim and J. Jung, "A Polymer Cable Creep Modeling for a Cable-Driven Parallel Robot in a Heavy Payload Application," **In: Cable-Driven Parallel Robots: Proceedings of the Third International Conference on Cable-Driven Parallel Robots**, (Springer, 2018) pp. 62–72.
- [40] J. Piao, X. J. Jin, J. Jung, E. Choi, J.-O. Park and C.-S. Kim, "Open-loop position control of a polymer cable-driven parallel robot via a viscoelastic cable model for high payload workspaces," *Adv Mech Eng* **9**(12), 168781401773719 (2017).
- [41] S. Nanthacoumarane, B. Wang, A. Kouadri-Henni, P. Cardou and S. Caro, "Polymer Cable Characterization in Cable-Driven Parallel Robots," **In: 25ème Congrès Français De Mécanique Nantes**, (2022).
- [42] J. Oyekan and A. Grimshaw, "Applying deep reinforcement learning to cable driven parallel robots for balancing unstable loads: A ball case study," *Front Robot AI* **7**, 212 (2020).
- [43] Y. Xiang, Q. Li and X. Jiang, "Dynamic rotational trajectory planning of a cable-driven parallel robot for passing through singular orientations," *Mech Mach Theory* **158**, 104223 (2021).
- [44] R. Babaghasabha, M. A. Khosravi and H. D. Taghirad, "Adaptive robust control of fully constrained cable robots: Singular perturbation approach," *Nonlinear Dynam* **85**(1), 607–620 (2016).
- [45] X. Diao, "Singularity Analysis of Fully-Constrained Cable-Driven Parallel Robots with Seven Cables," **In: IEEE International Conference on Mechatronics and Automation (ICMA)**, (IEEE, 2015) pp. 1537–1541.
- [46] B. Zi, X. Wu, J. Lin and Z. Zhu, "Inverse kinematics and singularity analysis for a 3-DOF hybrid-driven cable-suspended parallel robot," *Int J Adv Robot Syst* **9**(4), 133 (2012).
- [47] E. Khoshbin, K. Youssef, R. Meziane and M. J.-D. Otis, "Reconfigurable fully constrained cable-driven parallel mechanism for avoiding collision between cables with human," *Robotica* **40**(12), 4405–4430 (2022).

- [48] T. Rousseau, C. Chevallereau and S. Caro, "Human-cable collision detection with a cable-driven parallel robot," *Mechatronics* **86**, 102850–2850 (2022).
- [49] Y. Zou, Y. Hu, H. Cao, Y. Xu, Y. Yu, W. Lu and H. Xiong, "Data-Driven Kinematic Control Scheme for Cable-Driven Parallel Robots Allowing Collisions," **In: IEEE/RSJ International Conference on Intelligent Robots and Systems (IROS)**, (2022) pp. 5003–5008.
- [50] Y. Hu, Y. Zou, H. Cao, W. Lu and H. Xiong, "Modeling and Control of a Cable-Driven Parallel Robot Allowing Cable-edge Collisions," **In: International Conference on Advanced Robotics and Mechatronics (ICARM)**, (IEEE, 2022) pp. 483–487.
- [51] D. Bury, J-B Izard, M. Gouttefarde and F. Lamiraux, "Continuous Collision Detection for a Robotic Arm Mounted on a Cable-Driven Parallel Robot," **In: IEEE/RSJ International Conference on Intelligent Robots and Systems (IROS)**, (IEEE, 2019) pp. 8097–8102.
- [52] J.-H. Bak, S. W. Hwang, J. Yoon, J. H. Park and J.-O. Park, "Collision-free path planning of cable-driven parallel robots in cluttered environments," *Intel Serv Robot* **12**(3), 243–253 (2019).
- [53] M. A. Carpio-Aleman, R. J. Salterán-Pasmio, A. Rodríguez, G. A. Portilla, J. S. Cely, N. X. González-Álvarez and J. M. Castillo-Guerrero, "Collision and Tension Analysis of Cable-Driven Parallel Robot for Positioning and Orientation," **In: IEEE International Autumn Meeting on Power, Electronics and Computing (ROPEC)**, (IEEE, 2018) pp. 1–6.
- [54] M. Fabritius, C. Martin and A. Pott, "Calculation of the Cable-Platform Collision-Free Total Orientation Workspace of Cable-Driven Parallel Robots," **In: Cable-Driven Parallel Robots: Proceedings of the 4th International Conference on Cable-Driven Parallel Robots**, (Springer, 2019) pp. 4.
- [55] M. Lesellier and M. Gouttefarde, "A Bounding Volume of the Cable Span for Fast Collision Avoidance Verification," **In: Cable-Driven Parallel Robots: Proceedings of the 4th International Conference on Cable-Driven Parallel Robots**, (Springer, 2019) pp. 4.
- [56] T. Makino and T. Harada, "Cable Collision Avoidance of a Pulley Embedded Cable-Driven Parallel Robot by Kinematic Redundancy," **In: Proceedings of the 4th International Conference on Control, Mechatronics and Automation**, (2016) pp. 117–120.
- [57] B. Wang, B. Zi, S. Qian and D. Zhang, "Collision Free Force Closure Workspace Determination of Reconfigurable Planar Cable Driven Parallel Robot," **In: Asia-Pacific Conference on Intelligent Robot Systems (ACIRS)**, (IEEE, 2016) pp. 26–30.
- [58] R. Bordalba, J. M. Porta and L. Ros, "Randomized Kinodynamic Planning for Cable-Suspended Parallel Robots," **In: Cable-Driven Parallel Robots: Proceedings of the Third International Conference on Cable-Driven Parallel Robots** (Springer International Publishing, 2018) pp. 195–206.
- [59] F. Ennaïem, A. Chaker, M. A. Laribi, J. Sandoval, S. Bennour, A. Mlika, L. Romdhane and S. Zeghloul, "A Reconfigurable 6-dof Cable-Driven Parallel Robot with an Extended Rotational Workspace," **In: Mechanism Design for Robotics: MEDER**, (Springer, 2021) pp. 322–331.
- [60] J. Xu and K.-S. Park, "A real-time path planning algorithm for cable-driven parallel robots in dynamic environment based on artificial potential guided RRT," *Microsyst Technol* **26**(11), 3533–3546 (2020).
- [61] L. Barbazza, F. Oscarì, S. Minto and G. Rosati, "Trajectory planning of a suspended cable driven parallel robot with reconfigurable end effector," *Robot Com Int Manuf* **48**, 1–11 (2017).
- [62] U. A. Mishra, S. Caro and M. Gouttefarde, "Optimizing Cable-Routing for Reconfigurable Cable-Driven Parallel Robots," **In: ReMAR-5th IEEE/IFToMM International Conference on Reconfigurable Mechanisms and Robots**, (2021).
- [63] F. Trautwein, T. Reichenbach, A. Pott and A. Verl, "Workspace Planning for In-Operation-Reconfiguration of Cable-Driven Parallel Robots," **In: Cable-Driven Parallel Robots: Proceedings of the 5th International Conference on Cable-Driven Parallel Robots**, (Springer, 2021) pp. 182–193.
- [64] J. Xu and K.-S. Park, "Moving obstacle avoidance for cable-driven parallel robots using improved RRT," *Microsyst Technol* **27**(6), 2281–2292 (2021).
- [65] L. Gagliardini, M. Gouttefarde and S. Caro, "Design of Reconfigurable Cable-Driven Parallel Robots," **In: Mechatronics for Cultural Heritage and Civil Engineering**, (Springer, 2018) pp. 85–113.
- [66] R. Meziane, P. Cardou and M. J.-D. Otis, "Cable interference control in physical interaction for cable-driven parallel mechanisms," *Mech Mach Theory* **132**, 30–47 (2019).
- [67] M. Rushton and A. Khajepour, "Planar variable structure cable-driven parallel robots for circumventing obstacles," *J Mech Robot* **13**(2), 021011 (2021).
- [68] A. M. Pinto, E. Moreira, Jé Lima, Jé P. Sousa and P. Costa, "A cable-driven robot for architectural constructions: A visual-guided approach for motion control and path-planning," *Auton Robot* **41**(7), 1487–1499 (2017).
- [69] A. Martin, S. Caro and P. Cardou, "Geometric Determination of the Cable-Cylinder Interference Regions in the Workspace of a Cable-Driven Parallel Robot," **In: Cable-Driven Parallel Robots: Proceedings of the Third International Conference on Cable-Driven Parallel Robots**, (Springer, 2018) pp. 117–127.
- [70] X. Wang, B. Zhang, W. Shang and S. Cong, "Optimal reconfiguration planning of a 3-DOF point-mass cable-driven parallel robot," *IEEE Trans Ind Electron* **71**(3), 2672–2682 (2023).
- [71] X. Wang, B. Zhang, W. Shang, F. Zhang and S. Cong, "Constrained path planning for reconfiguration of cable-driven parallel robots," *IEEE/ASME Trans Mechatron* **28**(4), 2352–2363 (2023).
- [72] L. Gagliardini, S. Caro, M. Gouttefarde, P. Wenger and A. Girin, "A Reconfigurable Cable-Driven Parallel Robot for Sandblasting and Painting of Large Structures," **In: Cable-Driven Parallel Robots: Proceedings of the Second International Conference on Cable-Driven Parallel Robots**, (Springer, 2015) pp. 275–291.
- [73] L. Gagliardini, S. Caro, M. Gouttefarde and A. Girin, "Discrete reconfiguration planning for cable-driven parallel robots," *Mech Mach Theory* **100**, 313–337 (2016).

- [74] T. Chen, S. Qian, Y. Li and Z. Yin, "Mechanism Design and Analysis for an Automatical Reconfiguration Cable-Driven Parallel Robot," **In: 2nd International Conference on Cybernetics, Robotics and Control (CRC)**, (IEEE, 2017) pp. 45–50.
- [75] H. Xiong, H. Cao, W. Zeng, J. Huang, X. Diao, W. Lu and Y. Lou, "Real-time reconfiguration planning for the dynamic control of reconfigurable cable-driven parallel robots," *J Mech Robot* **14**(6), 060913 (2022).
- [76] A. Raman, I. Walker, V. Krovi and M. Schmid, "A failure identification and recovery framework for a planar reconfigurable cable driven parallel robot," *IFAC-PapersOnLine* **55**(37), 369–375 (2022).
- [77] R. Muntashir and L. Nurahmi, "Reconfiguration of Cable Driven Parallel Robot Based on Mobile Base Position," **In: IEEE International Conference on Mechatronics and Automation (ICMA)**, (2022) pp. 563–568.
- [78] X. Wang, Y. Li, Zi B., Q. Wu and J. Zhao, "Obstacle Avoidance Planning and Experimental Study of Reconfigurable Cable-Driven Parallel Robot Based on Deep Reinforcement Learning," **In: Intelligent Robotics and Applications: 15th International Conference, ICIRA**, (Springer, 2022) pp. 541–551.
- [79] R. Kumar and S. Mukherjee, "Enhanced dynamic capability of cable-driven parallel manipulators by reconfiguration," *Robotica* **39**(12), 2153–2171 (2021).
- [80] G. Abbasnejad and M. Tale-Masouleh, "Optimal Wrench-Closure Configuration of Spatial Reconfigurable Cable-Driven Parallel Robots," *Proc Inst Mech Eng Pt C: J Mech Eng Sci* **235**(19), 4049–4056 (2021).
- [81] R. Boumann and T. Bruckmann, "An Emergency Strategy for Cable Failure in Reconfigurable Cable Robots," **In: Cable-Driven Parallel Robots: Proceedings of the 5th International Conference on Cable-Driven Parallel Robots**, (Springer, 2021) pp. 217–229.
- [82] A. Rodriguez-Barroso, R. Saltaren, G. A. Portilla, J. S. Cely and M. Carpio, "Cable-driven parallel robot with reconfigurable end effector controlled with a compliant actuator," *Sensors* **18**(9), 2765 (2018).
- [83] T. Zhao, B. Zi, S. Qian, Z. Yin and D. Zhang, "Typical configuration analysis of a modular reconfigurable cable-driven parallel robot," *Int J Adv Robot Syst* **16**(2), 1729881419834756 (2019).
- [84] A. Raman, M. Schmid and V. Krovi, "Stiffness Modulation for a Planar Mobile Cable-Driven Parallel Manipulators via Structural Reconfiguration," **In: International Design Engineering Technical Conferences and Computers and Information in Engineering Conference** (American Society of Mechanical Engineers, 2020) Vol. 83990, p. V010T10A054.
- [85] M. A. Carpio Alemán, R. Saltaren, A. Rodriguez, G. Portilla and J. Diego Placencia, "Rotational workspace expansion of a planar CDPR with a circular end-effector mechanism allowing passive reconfiguration," *Robotics* **8**(3), 57 (2019).
- [86] H. Wang, J. Kinugawa and K. Kosuge, "Exact kinematic modeling and identification of reconfigurable cable-driven robots with dual-pulley cable guiding mechanisms," *IEEE/ASME Trans Mechatron* **24**(2), 774–784 (2019).
- [87] M. Ismail, S. Lahouar and L. Romdhane, "Collision-free and dynamically feasible trajectory of a hybrid cable-serial robot with two passive links," *Robot Auton Syst* **80**, 24–33 (2016).
- [88] H. Tourajzadeh and M. H. Korayem, "Optimal regulation of a cable suspended robot equipped with cable interfering avoidance controller," *Adv Robotics* **30**(19), 1273–1287 (2016).
- [89] M. Anson, A. Alamdari and V. Krovi, "Orientation workspace and stiffness optimization of cable-driven parallel manipulators with base mobility," *J Mech Robot* **9**(3), 031011 (2017).
- [90] R. Verhoeven, Analysis of the workspace of tendon based Stewart platforms, Duisburg, Essen, Univ., Diss., (2004).
- [91] R. Kelaiaia, O. Company and A. Zaatri, "Multiobjective optimization of a linear delta parallel robot," *Mech Mach Theory* **50**, 159–178 (2012).
- [92] V. L. Schmidt. *Modeling Techniques and Reliable Real-Time Implementation of Kinematics for Cable-Driven Parallel Robots Using Polymer Fiber Cables* (Fraunhofer Verlag, Stuttgart, 2017).
- [93] M. Peng, L. Xiao, Q. Chen, G. Wei, Q. Lin and J. Zhuo, "Dynamic modeling and characterization of compliant cable-driven parallel robots containing flexible cables," *Robotica* **41**(10), 3160–3174 (2023).
- [94] E. Picard, S. Caro, F. Claveau and F. Plestan, "Pulleys and Force Sensors Influence on Payload Estimation of Cable-Driven Parallel Robots," **In: IEEE/RSJ International Conference on Intelligent Robots and Systems (IROS)**, (IEEE, 2018) pp. 1429–1436.
- [95] S. Baklouti, E. Courteille, S. Caro and M. Dkhil, "Dynamic and oscillatory motions of cable-driven parallel robots based on a nonlinear cable tension model," *J Mech Robot* **9**(6), 061014 (2017).
- [96] S.-H. Choi and K.-S. Park, "Integrated and nonlinear dynamic model of a polymer cable for low-speed cable-driven parallel robots," *Microsyst Technol* **24**(11), 4677–4687 (2018).
- [97] D. Q. Nguyen, M. Gouttefarde, O. Company and F. Pierrot, "On the Simplifications of Cable Model in Static Analysis of Large-Dimension Cable-Driven Parallel Robots," **In: IEEE/RSJ International Conference on Intelligent Robots and Systems**, (IEEE, 2013) pp. 928–934.
- [98] G. Mottola, C. Gosselin and M. Carricato, "Dynamically feasible periodic trajectories for generic spatial three-degree-of-freedom cable-suspended parallel robots," *J Mech Robot* **10**(3), 031004 (2018).
- [99] D. Gueners, B.-C. Bouzgarrou and H. Chanal, "Cable behavior influence on cable-driven parallel robots vibrations: Experimental characterization and simulation," *J Mech Robot* **13**(4), 041003 (2021).
- [100] P. Miermeister, W. Kraus, T. Lan and A. Pott, "An Elastic Cable Model for Cable-Driven Parallel Robots Including Hysteresis Effects," **In: Cable-Driven Parallel Robots: Proceedings of the Second International Conference on Cable-Driven Parallel Robots**, (Springer, 2015) pp. 17–28.
- [101] M. H. Korayem, M. Yousefzadeh and H. Tourajzadeh, "Optimal control of a wheeled mobile cable-driven parallel robot ICaBot with viscoelastic cables," *Robotica* **38**(8), 1513–1537 (2020).
- [102] M. H. Korayem, M. Yousefzadeh and B. Beyranvand, "Dynamics and control of a 6-dof cable-driven parallel robot with visco-elastic cables in presence of measurement noise," *J Intell Robot Syst* **88**(1), 73–95 (2017).

- [103] Q. Duan, V. Vashista and S. K. Agrawal, "Effect on wrench-feasible workspace of cable-driven parallel robots by adding springs," *Mech Mach Theory* **86**, 201–210 (2015).
- [104] E. Picard, S. Caro, F. Plestan and F. Claveau, "Control Solution for a Cable-Driven Parallel Robot with Highly Variable Payload," **In: International Design Engineering Technical Conferences and Computers and Information in Engineering Conference** (American Society of Mechanical Engineers, 2018) Vol. 51814, p. V05BT07A013.
- [105] A. Pott, *Influence of Pulley Kinematics On Cable-Driven Parallel Robots. Latest Advances in Robot Kinematics* (Springer, Netherlands, 2012).
- [106] E. Barnett and C. Gosselin, "Large-scale 3D printing with a cable-suspended robot," *Addit Manuf* **7**, 27–44 (2015).
- [107] M. Hiller, S. Fang, S. Mielczarek, R. Verhoeven and D. Franitz, "Design, analysis and realization of tendon-based parallel manipulators," *Mech Mach Theory* **40**(4), 429–445 (2005).
- [108] M. Rognant and E. Courteille, "Improvement of Cable Tension Observability through a New Cable Driving Unit Design," **In: Cable-Driven Parallel Robots: Proceedings of the Third International Conference on Cable-Driven Parallel Robots** (Springer International Publishing, 2018) pp. 280–291.
- [109] A. Hay and J. Snyman, "Optimization of a planar tendon-driven parallel manipulator for a maximal dextrous workspace," *Eng Optimiz* **37**(3), 217–236 (2005).
- [110] A. Gonzalez-Rodriguez, F. J. Castillo-Garcia, E. Ottaviano, P. Rea and A. G. Gonzalez-Rodriguez, "On the effects of the design of cable-driven robots on kinematics and dynamics models accuracy," *Mechatronics* **43**, 18–27 (2017).
- [111] T. Paty, N. Binaud, S. Caro and S. Segonds, "Cable-driven parallel robot modelling considering pulley kinematics and cable elasticity," *Mech Mach Theory* **159**, 104263 (2021).
- [112] L. Gagliardini, S. Caro and M. Gouttefarde, "Dimensioning of Cable-Driven Parallel Robot Actuators, Gearboxes and Winches According to the Twist Feasible Workspace," **In: IEEE International Conference on Automation Science and Engineering (CASE)**, (IEEE, 2015) pp. 99–105.
- [113] S. M. D. Banadaki, *Modelling and Control of Cable-Driven Robots* Doctoral dissertation (Nanyang Technological University, 2007).
- [114] W. Yang Ho, W. Kraus, A. Mangold and A. Pott, "Haptic Interaction with a Cable-Driven Parallel Robot using Admittance Control," **In: Cable-Driven Parallel Robots: Proceedings of the Second International Conference on Cable-Driven Parallel Robots**, (Springer, 2015) pp. 201–212.
- [115] E. Ottaviano, A system for tension monitoring in cable-based parallel architectures. 12th IFToMM world congress, (2007).
- [116] A. Pott, H. Mütterich, W. Kraus, V. Schmidt, P. Miermeister and A. Verl, "IPAnema: A Family of Cable-Driven Parallel Robots for Industrial Applications," **In: Cable-Driven Parallel Robots**, (Springer, 2013) pp. 119–134.
- [117] W. E. Heap, C. T. Keeley, E. B. Yao, N. D. Naclerio and E. W. Hawkes, "Capstan winch for mobile robots," *IEEE Robot Autom Lett* **7**(4), 9873–9880 (2022).
- [118] X. Diao and O. Ma, "Vibration analysis of cable-driven parallel manipulators," *Multibody Syst Dyn* **21**(4), 347–360 (2009).
- [119] J. Piao, J. Jung, J.-A. Seon, S. Park, J.-O. Park and S. Y. Ko, "Simulation of Effect of Cable Robot Configuration on Natural Frequency," **In: IEEE International Conference on Mechatronics and Automation (ICMA)**, (IEEE, 2015) pp. 1828–1833.
- [120] H. Lamine, S. Bennour and L. Romdhane, "Design of cable-driven parallel manipulators for a specific workspace using interval analysis," *Adv Robotics* **30**(9), 585–594 (2016).
- [121] J. Pusey, A. Fattah, S. Agrawal and E. Messina, "Design and workspace analysis of a 6-6 cable-suspended parallel robot," *Mech Mach Theory* **39**(7), 761–778 (2004).
- [122] V. Cobilean, A. Oarcea and S.-D. Stan, "Analysis of Kinematic Dexterity Based on a 2 DOF Incompletely Restrained Cable-Driven Parallel Robot," **In: 9th International Conference on Modern Power Systems (MPS)**, (IEEE, 2021) pp. 1–6.
- [123] H. Xiong and X. Diao, "The Effect of Cable Tensions on the Stiffness of Cable-Driven Parallel Manipulators," **In: IEEE International Conference on Advanced Intelligent Mechatronics (AIM)**, (IEEE, 2017) pp. 1185–1190.
- [124] E. Ali and N. Aphiratsakun, "AU Ball on Plate Balancing Robot," **In: IEEE International Conference on Robotics and Biomimetics (ROBIO)**, (IEEE, 2015) pp. 2031–2034.
- [125] E. Khoshbin, M. Otis and R. Meziane, Ramy Meziane, Design of reconfigurable cable driven parallel mechanism, (2024), Available from: <https://osf.io/65nfs/>.
- [126] Y. Wischnitzer, N. Shvally and M. Shoham, "Wire-driven parallel robot: Permitting collisions between wires," *Int J Robot Res* **27**(9), 1007–1026 (2008).
- [127] S. S. Ge and Y. J. Cui, "Dynamic motion planning for mobile robots using potential field method," *Auton Robot* **13**(3), 207–222 (2002).
- [128] M. Ding, X. Zheng, L. Liu, J. Guo and Y. Guo, "Collision-free path planning for cable-driven continuum robot based on improved artificial potential field," *Robotica* **42**(5), 1350–1367 (2024).
- [129] X. Yang, L. M. Alvarez and T. Bruggemann, "A 3D collision avoidance strategy for UAVs in a non-cooperative environment," *J Intell Robot Syst* **70**(1-4), 315–327 (2013).
- [130] A. Chakravarthy and D. Ghose, "Generalization of the collision cone approach for motion safety in 3-D environments," *Auton Robot* **32**(3), 243–266 (2012).
- [131] X. Diao, O. Ma and Q. Lu, "Singularity Analysis of Planar Cable-Driven Parallel Robots," **In: IEEE Conference on Robotics, Automation and Mechatronics**, (IEEE, 2008) pp. 272–277.
- [132] L. Gagliardini, S. Caro, M. Gouttefarde and A. Girin, "A Reconfiguration Strategy for Reconfigurable Cable-Driven Parallel Robots," **In: IEEE International Conference on Robotics and Automation (ICRA)**, (IEEE, 2015) pp. 1613–1620.
- [133] M. J.-D. Otis, T.-L. Nguyen-Dang, T. Laliberté, D. Ouellet, D. Laurendeau and C. Gosselin, "Cable tension control and analysis of reel transparency for 6-dof haptic foot platform on a cable-driven locomotion interface," *Int J Electric Electron Eng* **3**(1), 16–29 (2009).

- [134] Z. Zake, F. Chaumette, N. Pedemonte and S. Caro, "Vision-based control and stability analysis of a cable-driven parallel robot," *IEEE Robot Autom Lett* **4**(2), 1029–1036 (2019).
- [135] H. Bayani, R. Sadeghian, M. T. Masouleh and A. Kalhor, "On the Control of Planar Cable-Driven Parallel Robot via Classic Controllers and Tuning with Intelligent Algorithms," *In: 3rd RSI International Conference on Robotics and Mechatronics (ICROM)*, (IEEE, 2015) pp. 623–658.
- [136] W. Lv, L. Tao and Z. Ji, "Sliding mode control of cable-driven redundancy parallel robot with 6 DOF based on cable-length sensor feedback," *Math Probl Eng* **2017**(1), 221–232 (2017).
- [137] J. C. Santos, A. Chemori and M. Gouttefarde, "Model Predictive Control of Large-Dimension Cable-Driven Parallel Robots," *In: International Conference on Cable-Driven Parallel Robots*, (Springer, 2019) pp. 221–232.
- [138] A. Aflakiyan, H. Bayani and M. T. Masouleh, "Computed Torque Control of a Cable Suspended Parallel Robot," *In: 3rd RSI International Conference on Robotics and Mechatronics (ICROM)*, (IEEE, 2015) pp. 749–754.
- [139] S. Khalilpour, R. Khorrambakht, H. D. Taghirad and P. Cardou, "Dual space control of a deployable cable driven robot: Wave based approach," *Int J Robot Theory Appl* **6**(1), 11–19 (2020).
- [140] S. Khalilpour, R. Khorrambakht, M. J. Harandi, H. D. Taghirad and P. Cardou, "Cascade Terminal Sliding Mode Control of a Deployable Cable Driven Robot," *In: 6th International Conference on Control, Instrumentation and Automation (ICCIA)*, (IEEE, 2019) pp. 1–6.
- [141] S. A. Khalilpour, R. Khorrambakht, M. J. Harandi, H. D. Taghirad and P. Cardou, "Robust Dynamic Sliding Mode Control of a Deployable Cable Driven Robot," *In: Electrical Engineering (ICEE), Iranian Conference on*, (IEEE, 2018) pp. 863–868.
- [142] C. Sancak, F. Yamac and M. Itik, "Position control of a planar cable-driven parallel robot using reinforcement learning," *Robotica* **40**(10), 1–18 (2022).
- [143] A. A. Kumar, J.-F. Antoine and G. Abba, "Input-output feedback linearization for the control of a 4 cable-driven parallel robot," *IFAC-PapersOnLine* **52**(13), 707–712 (2019).
- [144] A. Kiani and S. K. M. Mashhadi, "Lyapunov-based adaptive control of a cable-driven parallel robot," *Int J Adv Mechatron Syst* **7**(4), 193–201 (2017).
- [145] M. Aghaseyedabdollah, M. Abedi and M. Pourgholi, "Supervisory adaptive fuzzy sliding mode control with optimal jaya based fuzzy PID sliding surface for a planer cable robot," *Soft Comput* **26**(17), 8441–8458 (2022).
- [146] J. C. Santos, A. Chemori and M. Gouttefarde, "Model Predictive Control of Large-Dimension Cable-Driven Parallel Robots," *In: Cable-Driven Parallel Robots: Proceedings of the 4th International Conference on Cable-Driven Parallel Robots*, (Springer, 2019) pp. 4.
- [147] M. Gouttefarde, J. Lamaury, C. Reichert and T. Bruckmann, "A versatile tension distribution algorithm for  $n$ -DOF parallel robots driven by  $n+2$  cables," *IEEE Trans Robot* **31**(6), 1444–1457 (2015).
- [148] D. L. Winter and C. Ament, "Development of Safety Concepts for Cable-Driven Parallel Robots," *In: International Conference on Cable-Driven Parallel Robots*, (Springer, 2021) pp. 360–371.
- [149] M. A. Sassi, M. J.-D. Otis and A. Campeau-Lecours, "Active stability observer using artificial neural network for intuitive physical human-robot interaction," *Int J Adv Robot Syst* **14**(4), 1729881417727326 (2017).
- [150] J. Wang, Z. Fang, L. Shen and C. He, "Prediction of Human Motion with Motion Optimization and Neural Networks," *In: 3rd International Symposium on Robotics & Intelligent Manufacturing Technology (ISRIMT)*, (IEEE, 2021) pp. 66–70.
- [151] C. Urrea and J. Kern, "A new model for analog servo motors. Simulations and experimental results," *Canadian J Autom Cont Intell Syst* **2**(2), 29–38 (2011).
- [152] B. Ouyang and W. Shang, "Rapid optimization of tension distribution for cable-driven parallel manipulators with redundant cables," *Chin J Mech Eng* **29**(2), 231–238 (2016).
- [153] T. Rasheed, L. Michel, S. Caro, J.-P. Null Barbot and Y. Aoustin, "Dynamic Parameter Identification for Cable-Driven Parallel Robots," *In: International Conference on Cable-Driven Parallel Robots*, (Springer, 2023).