

# KOLMOGOROV UNSTABLE STELLAR OSCILLATIONS\*

J. PERDANG\*\*

*Institute of Astronomy, Cambridge, CB3 0HA, England*

*and*

*Institut d'Astrophysique, Cointe-Ougrée, B-4200, Belgium†*

**Abstract.** We survey the mathematics of non-linear Hamiltonian oscillations with emphasis being laid on the more recently discovered Kolmogorov instability. In the context of radial adiabatic oscillations of stars this formalism predicts a Kolmogorov instability even at low oscillation energies, provided that sufficiently high linear asymptotic modes have been excited.

Numerical analysis confirms the occurrence of this instability. It is found to show up already among the lowest order modes, although high surface amplitudes are then required ( $|\delta r|/R \sim 0.5$  for an unstable fundamental mode – first harmonic coupling). On the basis of numerical evidence we conjecture that in the Kolmogorov unstable regime the enhanced coupling due to internal resonance effects leads to an equipartition of energy over all interacting degrees of freedom. We also indicate that the power spectrum of such oscillations is expected to display two components: A very broad band of overlapping pseudo-linear frequency peaks spread out over the asymptotic range, and a strictly non-linear  $1/f$ -noise type component close to the frequency origin.

It is finally argued that the Kolmogorov instability is likely to occur among non-linearly coupled non-radial stellar modes at a surface amplitude much lower than in the radial case. This lends support to the view that this instability might be operative among the solar oscillations.

## 1. Motivation

It has recently been observed that the SCLERA power spectra of solar oscillations (Brown *et al.*, 1978) are not incompatible with the presence of highly non-linear turbulent-like motions at the Sun's surface (Perdang, 1981; Blacher and Perdang, 1981b). Since the relative radial amplitudes of the reported motions are extremely small ( $|\delta r|/R < 10^{-5}$ ) most solar theorists, invoking the principle that small causes have small effects, are tempted to discard the suggestion that the non-linear coupling among the solar linear modes might have any serious influence on the actual oscillations. However a trivial illustration pinpoints a way to invalidate this rule in the context of interacting oscillators.

Take the coupled oscillator equations

$$\begin{aligned} \ddot{x} + \omega_x^2 x &= \varepsilon X(x, y), \\ \ddot{y} + \omega_y^2 y &= \varepsilon Y(x, y), \end{aligned} \tag{1}$$

where  $X$  and  $Y$  are non-linear functions and  $\varepsilon$  is a small parameter, with initial conditions  $x = y = 1$ ,  $\dot{x} = \dot{y} = 0$ ; suppose for instance  $X(x, y) = y^3 + \dots$ . In a standard

\* Proceedings of the 66th IAU Colloquium: *Problems in Solar and Stellar Oscillations*, held at the Crimean Astrophysical Observatory, U.S.S.R., 1–5 September, 1981.

\*\* Chercheur Qualifié FNRS, Belgium.

† Permanent address.

perturbation scheme the first correction to the harmonic oscillator solution in  $x$  due to the contribution  $y^3$  is of order  $\varepsilon/(\omega_x^2 - \omega_y^2)$ ; therefore if a sufficiently sharp resonance between both linear frequencies takes place, then the perturbation procedure suggests that a finite correction can be produced even though the coupling parameter  $\varepsilon$  is infinitesimal. By the same token, since butterfly effects typically characterise unstable situations, the above example makes it plausible that internal resonances in weakly coupled oscillators may trigger some instability.

The main part of this paper is dedicated to a review of the rigorous mathematical information now available on the behaviour of non-linear Hamiltonian oscillators. Under special circumstances, among which the approximate internal resonances spotted above rank as necessary conditions, sinusoidal oscillations bifurcate towards a more irregular type of motion. In the available phase-space the latter occupy a zone of higher dimensionality\*. This transition is referred to as the Kolmogorov instability.

For exploratory reasons we analyse here the purely radial adiabatic stellar oscillations in the framework of this theory, the latter being trivially recast into a Hamiltonian form. Although the phenomenon of Kolmogorov unstable oscillations is far more likely to occur among non-radial stellar motions, our numerical experiments disclose that this instability can occur already in the radial case, and, perhaps rather unexpectedly, under favourable circumstances even among the lowest order radial modes.

We illustrate that this instability reveals itself most easily in the power spectrum of the surface displacement of the star: While prior to the transition, in the 'regular' regime, the spectrum shows just a few peaks in all of our experiments, each peak transforms into an irregular band displaying a highly complex substructure when the instability sets in; studies of the same motion at several spectral resolutions show that the bands disclose a statistically hierarchical fine-structure; this confers the spectrum of Kolmogorov unstable motions a noisy aspect. The time-behaviour of such motions lies in between regular, deterministic, and irregular, random or noisy variability, the degree of randomness being related to the width of the bands.

In this paper no attempt has been made to apply our numerical experiments to specific stellar situations. We merely point out that since non-radial oscillations are most vulnerable by this instability, Kolmogorov unstable motions on the Sun's surface deserve serious investigation. A conclusive numerical approach of this question, allowing a meaningful comparison of theoretical power spectra with their observational counterparts requires a non-linear coupling formulation involving a few hundred linear modes.

We wish to stress finally that while Hamiltonian oscillations are now reasonably well understood, there exists so far, to be best of our knowledge, no general theory of dissipative motions. The question then of how dissipation characteristically affects Kolmogorov unstable oscillations remains open.

\* Stellar vibrational instability gives rise to a similar change of dimensionality in phase-space: prior to the instability, the star's being in equilibrium shrinks the orbit to a point (0-dimensional) in phase-space; at the transition – a Hopf bifurcation in mathematical parlance – the point explodes into a closed curve (1-dimensional): the star is now periodically oscillating.

### 2. The Coupled Harmonic Oscillator-Approximation to Non-Linear Stellar Oscillations

To generate a set of adiabatic oscillation equations of a star which lends itself to a discussion in the framework of point-mechanics we rely on the energy principle. The potential energy  $V$  of the star, made up of the sum of the gravitational and the internal energy, and the kinetic energy of the internal motions  $K$ , are given by the following expressions:

$$V = -G \int_M dm \, m/r(m, t) + \int_M dm \, u(r(m, t), dr/dm), \tag{2}$$

$$K = \frac{1}{2} \int_M dm \, (dr(m, t)/dt)^2. \tag{3}$$

In these relations  $u$  denotes the specific internal energy which under local conservation of entropy (assumption of adiabatic motions) and mass becomes a function of the local radius  $r(m, t)$  and its derivative with respect to the mass variable. All other notations are standard. In this form the total energy allows us to fully describe the radial motions of a star in the neighbourhood of a state of minimum potential energy. To this end it suffices to apply the expansion procedure adopted in Demaret *et al.* (1978) in a slightly modified version. Since the eigenfunctions of the linear radial adiabatic oscillation problem of a star

$$\xi_n(m) = \delta r_n(m)/r(m), \quad n = 1, 2, \dots, \tag{4}$$

form a complete set, any radial displacement (satisfying physically reasonable smoothness conditions) can be expanded in the form

$$r(m, t) = r_E(m) \left[ 1 + \sum_n \xi_n(m) q_n(t) \right], \tag{5}$$

where  $r_E(m)$  denotes the local equilibrium radius and  $q_n(t)$  represents a set of weights attached to the linear amplitude distributions. We require the eigenfunctions to obey the usual normalisation

$$\int_M dm \, r(m)^2 \xi_k(m^*) \xi_l(m) = \delta_{kl}. \tag{6}$$

On substitution into Equations (2) and (3) we obtain for the total energy, if we set

$$p_n = dq_n/dt, \quad n = 1, 2, \dots \tag{7}$$

$$\begin{aligned} H(q_n, p_n) &= V_E + \frac{1}{2} \sum_k |p_k|^2 + \frac{1}{2} \sum_k \omega_k^2 |q_k|^2 + \frac{1}{3!} \sum_{klm} V_{klm}^{(3)} q_k q_l q_m + \dots \\ &= V_E + H^{(2)}(q_n, p_n) + V^{(3)}(q_n) + \dots \end{aligned} \tag{8}$$

The factor  $V_E$  denotes the potential energy of the equilibrium configuration. The coefficients  $\omega_k$  are the frequencies of the linear oscillations. The expansion coefficients  $V_{klm}^{(3)}$  can be derived directly from the formulae given in Demaret *et al.* (1978). The formal expansion (8) can be interpreted as a Hamiltonian describing an infinite number of non-linearly coupled harmonic oscillators, of generalised positions  $q_n$  and momenta  $p_n$ ,  $n = 1, 2, \dots$ . Since in any numerical application of this formalism we are bound to cut-off the expansion of the radius (5) at some finite number  $F$  of linear modes, we shall restrict our theoretical discussion to the latter situation. The Hamiltonian (8) then refers to the motion of  $F$  non-linearly coupled harmonic oscillators. Under the change of variables

$$q_n \rightarrow \varepsilon q_n, \quad p_n \rightarrow \varepsilon p_n, \quad H \rightarrow \varepsilon^{-2} H, \quad (9)$$

where  $\varepsilon$  is a small book-keeping parameter measuring the order of magnitude of the amplitudes of the motion, or equivalently the order of magnitude of the oscillation energy, we have

$$H(q_n, p_n) = H^{(2)}(q_n, p_n) + \varepsilon H^{(3)}(q_n) + \dots, \quad (8')$$

where  $H^{(2)}$  is the Hamiltonian of the uncoupled linear oscillations; the terms involving the small parameter  $\varepsilon$  describe the non-linear coupling, each  $H^{(k)}$ ,  $k = 3, 4, \dots$  being a homogeneous polynomial of degree  $k$  in the coordinates  $q_n$ . The equilibrium potential  $V_E$  is independent of the  $q_n, p_n$ ; it leads to no contribution to the motion we investigate and has therefore been discarded.

The Hamiltonian formalism of stellar oscillations dates back to Woltjer (1935, 1937, 1943; cf. also Rosseland, 1949). This author was particularly concerned with the determination of analytically expressible corrections to the harmonic oscillator solutions. In the next section we shall see that such procedures cease to be justified mathematically when certain resonance conditions in the harmonic oscillators are fulfilled.

### 3. Application of PBSKAM-Theory to Stellar Oscillations

We survey in this section a few mathematical results of point-mechanics which prove to be directly relevant to the stellar oscillation problem. These developments originated with Poincaré (P) in the last century, were continued by Birkhoff (B) and Siegel (S), and culminated in a celebrated theorem first formulated by Kolmogorov (K) and later proved by Arnold (A) and Moser (M) (the KAM theorem).

Consider first the Hamiltonian obtained if  $\varepsilon = 0$  in Equation (8'). Introduce a new set of canonical variables  $\varphi_n, J_n$ ,  $n = 1, 2, \dots, F$ , referred to as angle-action variables, defined as follows:

$$\begin{aligned} \omega_n^{1/2} q_n &= -(2J_n)^{1/2} \sin \varphi_n, \\ \omega_n^{-1/2} p_n &= +(2J_n)^{1/2} \cos \varphi_n, \quad n = 1, 2, \dots, F. \end{aligned} \quad (10)$$

In terms of the new variables the Hamiltonian depends on the actions  $J_n$  alone:

$$H = F(J_n). \quad (11)$$

The corresponding Hamiltonian equations can be integrated explicitly:

$$\begin{aligned}
 J_n(t) &= J_n^0, & \varphi_n(t) &= \varphi_n^0 + \Omega_n t \pmod{2\pi}, \\
 \Omega_n &\equiv \partial H / \partial J_n, & n &= 1, 2, \dots, F,
 \end{aligned}
 \tag{11'}$$

where  $J_n^0$  and  $\varphi_n^0$  are the initial conditions. Since the  $\varphi_n^0$  are angles, our convention is to define the latter in  $0 \leq \varphi_n < 2\pi$ ; the notation  $\varphi \pmod{2\pi}$  indicates that any value of  $\varphi$  originally not in the range 0 to  $2\pi$  is recast into that interval by adding or subtracting a multiple of  $2\pi$ . In the special case just envisaged  $H = H^{(2)}$  and  $\Omega_n = \omega_n$  (independent of  $J_n$ ). More generally, given an arbitrary Hamiltonian  $H(q_n, p_n)$ , it is said to be *integrable* if and only if a canonical transformation to angle-action variables exists such that the transformed Hamiltonian depends on the actions alone. For an integrable system the general solution can explicitly be written down (Equation (11')); expressed in the original variables  $q_n, p_n$  the motion is then given as an  $F$ -uple Fourier series

$$q_n(t) = \sum_{k_1 k_2 \dots k_F} A_{k_1 k_2 \dots k_F}^{(n)} \exp i(k_1 \Omega_1 + k_2 \Omega_2 + \dots + k_F \Omega_F) t \tag{11''}$$

and a similar expression for  $p_n(t)$ ,  $n = 1, 2, \dots, F$ , with  $k_1, k_2, \dots = 0, \pm 1, \pm 2, \dots$ . Under conditions of analyticity of the Hamiltonian the expansion coefficients obey

$$|A_{k_1 k_2 \dots k_F}^{(n)}| \leq A \exp -B |k|, \quad |k| = \sum_{i=1}^F |k_i|, \tag{11'''}$$

where  $A$  and  $B$  are positive constants independent of the  $k_i$ . Functions of type (11''), (11''') are known as *quasi-periodic* functions, and the corresponding motion is said to be a *quasi-periodic* motion.

Since total energy  $E$  is conserved during the motion, we represent the latter in terms of its angle-action variables (11') on the  $2F - 1$ -dimensional energy 'surface', which we parametrise by the coordinates  $\varphi_1, \varphi_2, \dots, \varphi_F, J_1, J_2, \dots, J_{F-1}$ . For a 2-oscillator system ( $F = 2$ ) we have illustrated the motion of an integrable Hamiltonian system in Figure 1. The energy 'surface' is represented by the box  $0 \leq \varphi_1 < 2\pi, 0 \leq \varphi_2 < 2\pi, 0 \leq J_1 \leq J_1^M, J_1^M$  being the maximum action  $J_1$  compatible with the value of the energy. For given initial conditions  $\varphi_1^0, \varphi_2^0, J_1^0, J_2^0 (= J_2(J_1^0, E))$ , the orbit is confined to the square  $ABCD$  at the position  $J_1 = J_1^0$  parallel to the angle plane  $\varphi_1, \varphi_2$ ; the trajectory is a straight line with the property that each time it touches an edge and disappears, it reappears on the opposite edge with same slope, at the projection of the point of disappearance. Such a square with opposite edges being identified ( $AB = DC$  and  $AD = BC$ ) has the geometrical structure of a doughnut (cf. Figure 1); therefore it is referred to as a 2-dimensional torus. In the general case of an integrable Hamiltonian system of  $F$  degrees of freedom, the motion (11') is likewise said to evolve on an  $F$ -dimensional torus of the  $2F - 1$ -dimensional energy manifold.

If the frequencies  $\Omega_n, n = 1, 2, \dots, F$ , are rationally dependent, or resonant, of order  $N$ , i.e. if a set of integers  $k_1, k_2, \dots, k_F$  exists such that

$$\sum_{n=1}^F k_n \Omega_n = 0 \quad \text{with} \quad |k| = N, \tag{12}$$

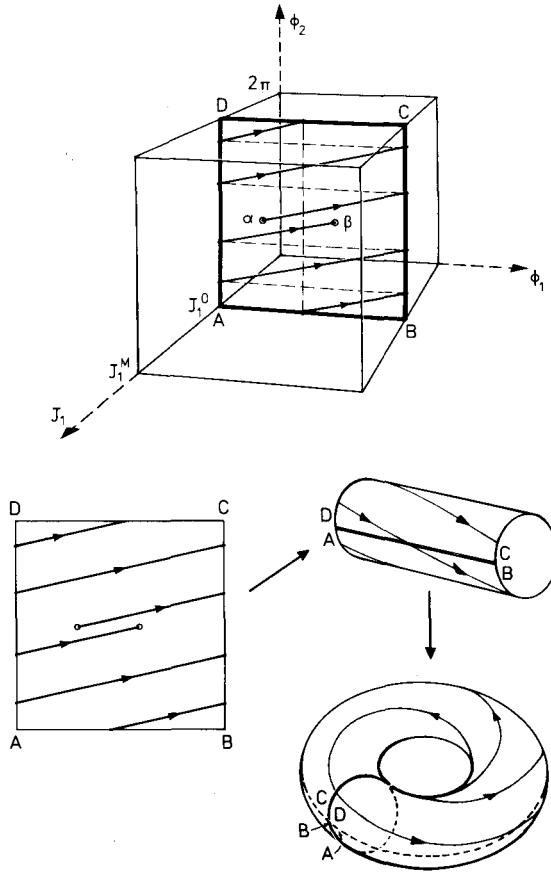

Fig. 1. The energy box  $H(\varphi_1, \varphi_2, J_1, J_2) = E = c^{st}$ ,  $0 \leq \varphi_1 < 2\pi$ ,  $0 \leq \varphi_2 < 2\pi$ ,  $0 \leq J_1 \leq J_1^M$  for an integrable system of 2 degrees of freedom; the orbit  $\alpha, \beta$  is carried by the square  $ABCD$  (equivalent to a torus, cf. bottom of figure).

then the orbit in the energy manifold is closed, so that the motion is periodic; the motion-carrying torus is then said to be a resonant torus. If for no set of integers  $k_1, k_2, \dots, k_F$ , whatever  $N$ , relation (12) can be satisfied, then the orbit will eventually go through any region, chosen as small as we like, on the torus; such an orbit covers the whole torus.

For integrable Hamiltonian systems the energy manifold is stratified into invariant tori: Any point of this manifold belongs to one and only one torus.

Integrability is not automatically shared by all Hamiltonian systems. This point was recognised by Poincaré (1890) who proved that the 3-body problem of celestial mechanics is precisely not integrable. Poincaré also seems to have been aware that integrability is in fact an exceptional property of Hamiltonian systems. In geometric terms the very existence of non-integrable Hamiltonian systems means that there are orbits which do not lie on tori; equivalently there are motions which do not admit of multiple Fourier expansions of type (11''), (11''').

A refinement of Poincaré’s result is due to Birkhoff (1927) who proved the following theorem:

If the Hamiltonian is given by a formal power series in  $\varepsilon$  (Equation (8’)), with the frequencies  $\omega_n$  entering the harmonic part  $H^{(2)}$  being rationally independent, then a formal canonical transformation exists,  $q_n, p_n \rightarrow Q_n, P_n, n = 1, 2, \dots, F$ , such that

$$H = F(J_n) = \sum_k \omega_k J_k + \frac{1}{2} \sum_{kl} \omega_{kl} J_k J_l + \dots \tag{13}$$

is a formal power series in the variables  $J_n$  defined by

$$\omega_n J_n = \frac{1}{2}(Q_n^2 \omega_n^2 + P_n^2), \quad n = 1, 2, \dots, F. \tag{13’}$$

The proof as given in Arnold (1963a, b) consists in the explicit construction of a sequence of canonical transformations

$$\begin{aligned} q_n, p_n &\rightarrow q'_n, p'_n && \text{generator: } S(q_n, p'_n), \\ q'_n, p'_n &\rightarrow q''_n, p''_n && S'(q'_n, p''_n), \\ \dots &&& \dots \end{aligned} \tag{14}$$

The generators of these transformations are determined by requiring that  $S(q_n, p'_n)$  eliminates the non-integrable contribution of order  $\varepsilon$  in the formal series of the Hamiltonian,  $S'(q'_n, p''_n)$  produces a vanishing order  $\varepsilon^2$  contribution, etc. These generators are sought in the form of multiple Fourier expansions; the Fourier coefficients then involve denominators  $\sum_{n=1}^F k_n \omega_n, k_n = 0, \pm 1, \pm 2, \dots (|k| \neq 0)$ . One finds that the generator  $S$  is formally defined if no resonances of order  $\leq 4$  occur among the linear frequencies; this generator then reduces the full Hamiltonian  $H$  (Equation (8’)) to the form:

$$H(q_n, p_n) = \left[ \sum_{n=1}^F \omega_n J_n + \frac{1}{2} \sum_{n,k} \omega_{nk} J_n J_k \right] + O(\varepsilon^2) = H_0(J_n) + O(\varepsilon^2), \tag{15}$$

where the  $O(\varepsilon^2)$  contribution does not depend on the action variables alone. To eliminate higher order non-integrable components in the formal series (15) higher order resonances are to be excluded as well.

The construction of this sequence of generators breaks down once the frequencies of the harmonic part  $H^{(2)}$  are resonant to some order  $N$ . This proves that resonances are responsible for destroying the integrability of the full Hamiltonian (Equation (8’)). But since for any set of frequencies  $\omega_1, \omega_2, \dots, \omega_F$  one can always find a set of integers  $k_1^*, k_2^*, \dots, k_F^*, k_n^* = 0, \pm 1, \pm 2, \dots |k^*| \neq 0$ , such that  $|\sum_{n=1}^F k_n^* \omega_n| \leq \eta, \eta$  being any preassigned precision, it becomes doubtful whether the series of generators and therefore also the formal series (13) are ever convergent.

The question of convergence or divergence was settled by Siegel (1954) who proved that the formal series (13) is generically divergent. If we choose at random a Hamiltonian among the class of Hamiltonians given by the series expansion (8’) with coefficients of the polynomials  $H^{(k)}$  in some finite interval, say  $(-1, +1)$ , then the probability of hitting an integrable Hamiltonian is zero. The typical property of a Hamiltonian is to be non-integrable.

This conclusion directly pertains to the weakly non-linear stellar oscillations: For general stellar models we have no reason to expect the oscillation Hamiltonian (Equation (8.8')) to possess the atypical property of integrability. Therefore solutions of the stellar oscillations in the form of Fourier type expansions (11'') as assumed in Woltjer's procedure, and more recently in the iterative technique adopted by Simon (1972), are not justified *a priori* in the presence of multi-mode coupling.

Non-integrability means that not all motions are carried by tori. What is physically relevant, however, is to know how frequent the orbits on tori are as compared to the totality of trajectories of a non-integrable Hamiltonian system, or more precisely to have information on the volume occupied by the regular, quasi-periodic motions in comparison with the whole volume of the energy manifold. A partial answer to this question is provided by the notorious KAM theorem (Kolmogorov, 1957):

If a Hamiltonian of a system of  $F$  degrees of freedom is given in the form

$$H(\varphi_n, J_n, \varepsilon) = H_0(J_n) + \varepsilon H_1(\varphi_n, J_n, \varepsilon), \tag{16}$$

where

(1)  $H$  is real analytic in all of its arguments, for  $0 < \varepsilon < \varepsilon_0$ , for  $J_n$  defined in some open region  $J$  of the  $F$ -dimensional action space, and for the angles  $0 \leq \varphi_n < 2\pi$ ,  $n = 1, 2, \dots, F$ , as well as periodic in the latter (of period  $2\pi$ );

(2) let  $J_n = J_n^0$ ,  $n = 1, 2, \dots, F$ , in  $J$ , characterise an invariant torus of the non-perturbed Hamiltonian  $H_0$  such that the frequencies

$$\Omega_n(J_m) = \partial H_0 / \partial J_n \quad \text{at} \quad J_n = J_n^0, \quad n = 1, 2, \dots, F \tag{17}$$

obey the non-quasi-resonance condition

$$\left| \sum_{n=1}^F k_n \Omega_n \right| \geq c |k|^{-\alpha} \quad \text{for any set of integers} \quad k_n = 0, \pm 1, \pm 2, \dots \tag{18}$$

( $|k| \neq 0$ )

for some positive constants  $c$  and  $\alpha$ , as well as the non-degeneracy condition

$$\text{dtm}(\partial^2 H_0 / \partial J_m \partial J_n) \neq 0 \quad \text{at} \quad J_n = J_n^0. \tag{18'}$$

Then, provided that  $\varepsilon_0$  is sufficiently small:

(1) there exists a deformed invariant torus

$$\begin{aligned} \varphi_n(t) &= \varphi_n^0(t) + \varepsilon \phi(\varphi_n^0(t), \varepsilon), \\ J_n(t) &= J_n^0 + \varepsilon A(\varphi_n^0(t), \varepsilon), \end{aligned} \tag{19}$$

with  $\phi$  and  $A$  real analytic functions of their arguments and periodic in the  $\varphi_n^0(t)$ , i.e. the angles of the non-perturbed orbit;

(2) if  $\Gamma$  is the open region in phase-space over which hypothesis (1) holds, and  $K$  the region filled out by the regular solutions (19), then  $K$  is closed and nowhere dense; moreover it covers most of  $\Gamma$ .

The latter stipulation means that the volume of the zone  $\Gamma - K$  occupied by non-quasiperiodic solutions can be made as small as we like if the coupling  $\varepsilon$  is small enough.



Region  $K$  is referred to as the Kolmogorov set. The first full proof of this theorem was given by Arnold (1963a). A perhaps more intuitive proof based on a procedure going back to Poincaré (1912), namely the method of the surface of section, or of area preserving Poincaré mappings, is due to Moser (1962, cf. also 1973). In essence, and for  $F = 2$ , this procedure amounts to studying the sequence of successive intersections of the orbit in the 3-dimensional energy manifold in the coordinate basis  $q_1, q_2, p_2$ , by the plane (surface of section)  $q_1 = 0$  with  $p_1 > 0$ . Denote by  $q_2^{(i)}, p_2^{(i)}$  the  $i$ th intersection point of the orbit with the surface of section; the transformation that carries  $q_2^{(j)}, p_2^{(j)}$  into  $q_2^{(j+1)}, p_2^{(j+1)}$ ,  $j = 1, 2, \dots$  is the Poincaré map. A motion on a torus (cf. Figure 1) shows up in the surface of section as a sequence of points all distributed along a closed curve (which can degenerate into a point). A closed curve being topologically equivalent to a circle, the simplest Poincaré map that simulates all topological features of any quasi-periodic Hamiltonian solution is the ‘twist map’

$$\begin{aligned} r^{(i+1)} &= r^{(i)}, \\ \varphi^{(i+1)} &= \varphi^{(i)} + \Omega(r^{(i)}), \end{aligned} \tag{20}$$

where  $\varphi, r$  are polar coordinates of the intersection points  $q_2, p_2$  in the surface of section; the twist map transforms the circle of radius  $r = r^{(i)}$ ,  $i = 1, 2$ , into itself. Any conceivable slight perturbation of the Hamiltonian deforms the corresponding Poincaré map (20) as follows:

$$\begin{aligned} r^{(i+1)} &= r^{(i)} + \varepsilon R(r^{(i)}, \varphi^{(i)}), \\ \varphi^{(i+1)} &= \varphi^{(i)} + \Omega(r^{(i)}) + \varepsilon \phi(r^{(i)}, \varphi^{(i)}). \end{aligned} \tag{20'}$$

(The Hamiltonian character of the motion requires area conservation of the map (20'),  $r^2 dr d\varphi = c^{st}$ , so that the functions  $R$  and  $\phi$  are not independent.) Moser proved that if

$$d\Omega/dr \neq 0 \tag{21}$$

and

$$|n\Omega - m2\pi| \geq c |n|^{-\alpha} \text{ for any set of integers } n, m \tag{22}$$

for some positive numbers  $c$  and  $\alpha$ , then the disturbance to the twist map generates again a closed curve in the surface of section that remains close to the original circle for  $\varepsilon$  sufficiently small. Note that conditions (21) and (22) duplicate the non-degeneracy and non-quasi-resonance requirements.

It was already known to Poincaré and Birkhoff that the twist map is unstable under slight perturbations (20') once  $\Omega = (m/n)2\pi$ ; under those conditions the original invariant circle is blown up, an even number of points on it remaining however fixed. The latter are alternatively stable and unstable: A stable fixed point has the property that the map (20') carries all points close to it into points that remain close to it; unstable fixed points of the Poincaré map have neighbouring points in the surface of section that do not stay close to those points under the transformation (20'). An unstable fixed point either (a) has the sequence of successive image points of any point in its neighbourhood

lying on a closed *curve*, or (b) there are points around it which under the iterated map (20') fill out an *area* in the surface of section. Alternative (a) occurs if the perturbed twist map simulates an integrable Hamiltonian system; it produces an explosion of the original torus into a series of second generation tori. Alternative (b) is the typical case; it tells us that the resonant tori, which densely cover the energy manifold, acquire a certain thickness along the action axes: these tori, of dimension  $F$ , explode into configurations of higher dimensionality  $\leq 2F - 1$ .

The motions carried by the Kolmogorov set  $K$  are quasi-periodic (Equations (11'), (11'')). The orbits lying outside  $K$  are 'Kolmogorov unstable' in Chirikov's terminology (Izrailev and Chirikov, 1966), or 'stochastic' (Zaslavskii and Chirikov, 1972), or 'chaotic'. So far the precise mathematical characteristics of these motions are not yet known.

We observe that for a system of  $F = 2$  coupled oscillators at low  $\epsilon$  viewed in the energy box of Figure 1, any exploded torus is necessarily sandwiched between two invariant tori of the Kolmogorov set. Therefore, the actions of Kolmogorov unstable motions are confined to narrow intervals (for  $F = 2$ ). This suggests that such motions still bear some resemblance with quasi-periodic motions.

If  $F > 2$ , an  $F$ -torus of the  $2F - 1$ -energy manifold no longer cuts the latter into two disconnected bits; therefore, the complementary set of the Kolmogorov tori i.e. the zone carrying the Kolmogorov unstable motions, can now become connected. The actions are then allowed to drift through the whole energy manifold. This phenomenon is known as the Arnold diffusion. Nekhoroshev (1977) proved that under special 'steepness' requirements of the non-perturbed Hamiltonian (Equation (16)), the actions  $J_n(t)$  obey

$$|J_n(t) - J_n^0| < \epsilon^b \quad \text{if} \quad 0 \leq t \leq T = \epsilon^{-1} \exp(\epsilon^{-a}), \tag{23}$$

$$n = 1, 2, \dots, F,$$

where  $a, b > 0$  depend on the non-perturbed Hamiltonian, and  $J_n^0$  represents the action of the solution of the integrable, non-perturbed Hamiltonian  $H_0$ . (The steepness hypothesis generalizes the stability condition  $|\partial H_0 / \partial J| > 0$  in a system with one degree of freedom).

We now adapt these results to the problem of stellar oscillations (Equation (8')). First observe that if we introduce action-angle variables defined by Equation (10) into the oscillation Hamiltonian, then the unperturbed part becomes

$$H^{(2)}(q_n, p_n) = F(J_n) = \sum_{k=1}^F \omega_k J_k, \tag{24}$$

with  $\omega_n = \Omega_n$  (Equation (11')). This integrable Hamiltonian violates the non-degeneracy requirement (18'), so that we cannot just use the harmonic oscillator approximation as the unperturbed system. However, we have seen in the analysis of Birkhoff's theorem that a canonical transformation exists reducing our stellar oscillation

Hamiltonian to the form (15); the terms between square brackets representing again an integrable Hamiltonian are now regarded as the non-perturbed Hamiltonian. The condition securing the existence of this transformation is given by

$$\sum_{n=1}^F k_n \omega_n \neq 0, \quad 0 < |k| = \sum_{n=1}^F |k_n| \leq 4. \quad (25)$$

For arbitrary generic stellar models we can assume that  $\det \omega_{ij} \neq 0$ , so that the non-degeneracy requirement (18') is now satisfied. Moreover, provided that the non-quasi-resonance condition (18) is obeyed, we fulfil the hypotheses of the KAM theorem.

The latter requirement demands that even approximate resonances

$$\sum_{n=1}^F k_n \omega_n \simeq 0 \quad (20)$$

have to be excluded among the linear oscillations. The precision to which this equality has to be fulfilled depends on the expansion parameter  $\varepsilon$ : small  $\varepsilon$  values demand a high accuracy in order to violate the KAM conditions (cf. next section).

We discuss now the possibility of resonances among radial stellar modes. In the first place, if we concentrate on the *sufficiently low* frequency part of the *linear spectrum*, the non-quasi-resonance condition is not violated in generic models and at a sufficiently low level of non-linearity  $\varepsilon$ . Exceptions occur in atypical models, constructed through an *ad hoc* selection of the model parameters to generate resonances: for instance among polytropes, by adjusting the index  $n$  it is possible to produce low order resonances in the low-frequency spectrum (cf. Simon, 1972). Such models have an almost zero probability to occur in reality. Therefore we have the following property:

(A) In a generic stellar model, if the radial modes of sufficiently low order are non-linearly coupled, and the oscillation energy is low enough, then most of the motions of this non-linear stellar oscillator remain close to the oscillations of the linear modes (KAM secures the closeness of the solutions to the motions of a non-linear integrable oscillator described by the non-perturbed Hamiltonian  $H_0$  (Equation (15)); but for sufficiently small non-linearity  $\varepsilon$ , or equivalently sufficiently small oscillation energy, the motion of the latter oscillator remains as close as we like to the linear oscillations).

Consider next the *sufficiently high asymptotic* part of the *linear spectrum*. The linear frequencies in the asymptotic regime obey a representation formula

$$(N \rightarrow \infty): \quad \omega_N = N\Omega_a + \Omega_0 + \Omega_1/N + O(1/N^2), \quad (27)$$

where  $\Omega_a, \Omega_0, \Omega_1, \dots$  are model constants. If  $\omega_N, \omega_{N+1}$  are two successive asymptotic frequencies, and if we express frequencies in units  $\omega_N = 1$ , we have

$$\omega_{N+1} - \omega_N = (1/N) + O(1/N^2). \quad (28)$$

By choosing  $N$  large enough we have a resonance of order 2 to any preassigned degree of precision. This shows that we violate the non-quasi-resonance conditions of KAM in any stellar model, on condition that we couple non-linearly adjacent modes of the asymptotic spectrum. Therefore:

(B) In any stellar model, if we fix an oscillation energy (chosen sufficiently small), and if we couple non-linearly radial asymptotic modes of sufficiently high order  $N$ , we have no guarantee that the motion of this non-linear oscillator remains close to the linear harmonic oscillations of the uncoupled modes.

#### 4. Empirical Data on the Kolmogorov Instability

The strict mathematical theory reviewed in the previous section does not answer the following questions:

- (1) What does a Kolmogorov unstable motion look like?
- (2) Under what conditions does the energy box carry a non-negligible fraction of Kolmogorov unstable tori?
- (3) How does the Kolmogorov instability influence the energy exchange among modes?

These questions have been investigated by semi-analytical techniques and by direct numerical experiments.

(1) It has been argued that since by definition such motions cannot be represented by multiple Fourier series (Equations (11''), (11''')), any phase-space coordinate  $q_n(t)$ ,  $p_n(t)$ , and therefore also any linear combination of the latter, must give rise to a highly structured power spectrum (Blacher and Perdang, 1981a). In fact, it has been found that power spectra of Kolmogorov unstable motions invariably have a complex structure (Noid *et al.*, 1977; Powell and Percival, 1979); a quasi-periodic motion in contrast has a spectrum typically displaying just a few fine lines. A detailed analysis of the unstable motions of the Hénon–Heiles coupled harmonic oscillators ( $F = 2$ ) (Hénon and Heiles, 1964) with a resonance  $\omega_1 = \omega_2$  in the harmonic approximation shows that the power spectra typically display two conspicuous features (Blacher and Perdang, 1981a): a broad resonance band at frequency  $\omega \sim \omega_1 = \omega_2$ , and a second lower broad band at the combination frequency  $|\omega_1 - \omega_2|$  (origin). The very existence of the first band tells us that a pseudo-periodicity survives in the Kolmogorov unstable regime. The spread in this band shows that this periodicity is not well-defined: If one views the profile of the band as a probability distribution of frequencies, then the motion can randomly switch from one frequency in the band to another; this is precisely observed in the analysis of the time-behaviour of the phase coordinates (Blacher and Perdang, 1981b). The second band near the origin can be given a similar probabilistic interpretation: it confers the motion an irregular long time-scale variability which manifests itself as an irregular amplitude modulation of the short time-scale pseudo-periodicity.

These heuristic results picture a Kolmogorov unstable motion as a blend of a deterministic, regular, component (reminiscent of a linear mode), and a purely random, irregular component; the degree of randomness is measured by the band-widths of the power spectra.

The appearance of a finite natural width of the frequency peaks under Kolmogorov instability is not surprising. It merely reflects the finite thickness of the exploded tori.

In fact, from Equation (17) we can say that each frequency  $\Omega_k(J_n)$  of the integrable Hamiltonian  $H_0$  explores an interval  $\Delta\Omega_k$  roughly given by  $\Delta\Omega_k \sim \sum_{l=1}^F |\partial^2 H_0 / \partial J_k \partial J_l| |\Delta J_l|$  on the exploded torus  $J_n \sim J_n^0$  of thickness  $\Delta J_n$ ,  $n = 1, 2, \dots, F$ .

We should mention also that the fractal dimension  $d$  of the (renormalised) bands of a power spectrum of Kolmogorov unstable motions obeys  $d \geq 1$ , while the power spectrum of regular motions has a dimension  $d = 1$ ; for the Hénon–Heiles unstable oscillations an approximate numerical technique devised to estimate this parameter (Perdang, 1981; Blacher and Perdang, 1981a) yields values in the range  $1.25 \lesssim d \lesssim 1.5$ .

(2) As regards the onset of an ‘observable’ Kolmogorov instability, i.e. the occurrence of Kolmogorov unstable motions over a fraction of phase-space of finite volume, it is found empirically that a mere violation of the KAM conditions is not sufficient to guarantee this phenomenon. The following empirical results are relevant in this connection.

The notorious experiments by Hénon and Heiles (1964) dealing with two harmonic oscillators of same frequency  $\omega_1 = \omega_2$ , coupled nonlinearly through the potential  $V_3(q_1, q_2) = q_1^2 q_2 - \frac{1}{3} q_2^3$  have established that the transition towards (observable) Kolmogorov instability sets in abruptly, at some threshold energy  $E_T$ ; the latter in turn is a fraction ( $> \frac{1}{2}$ ) of the escape energy  $v_c$ , i.e. the energy above which the equipotential curves cease to be closed. Below this threshold the probability of hitting an unstable solution is zero. For oscillation energies  $> E_T$  a sizeable fraction of phase-space becomes populated by stochastic solutions. These experiments show that the single resonance  $\omega_1 = \omega_2$  in an  $F = 2$  oscillator is not sufficient to generate Kolmogorov instability at low oscillation energy. The concept of a threshold energy has been clarified by Walker and Ford (1969) and developed by Zaslavskii and Chirikov (1972) (see also Chirikov, 1979), who pointed out that an overlap of exploded resonant tori is required to generate stochastic oscillations. We sketch this idea for an  $F = 2$  oscillator. Expand the perturbing Hamiltonian (cf. Equation (16)) in a Fourier series of the angle variables:

$$H(q_1, q_2, p_1, p_2) = H_0(J_1, J_2) + \varepsilon \sum_{n_1, n_2} H_{n_1, n_2}^c(J_1, J_2) \times \cos(n_1 \varphi_1 + n_2 \varphi_2) + \dots \tag{29}$$

From the equations of motions observe that a given Fourier component  $H_{n_1, n_2}^c(J_1, J_2)$  leads to a non-negligible contribution to  $J_1$  or  $J_2$  provided that

$$\varepsilon H_{n_1, n_2}^c(J_1, J_2) / [n_1 \Omega_1(J_1, J_2) + n_2 \Omega_2(J_1, J_2)] = O(1), \tag{30}$$

i.e., when a small divisor compensates for the small value of  $\varepsilon$ .

If just a single Fourier component  $H_{n_1, n_2}^c$  is non-zero in the expansion (29), the full Hamiltonian is seen to remain integrable. At fixed energy  $E$  the denominator in (30) becomes small on some torus  $J_1^0$  of the unperturbed Hamiltonian; this torus then explodes under the influence of the perturbation, (cf. the discussion of the twist map).

However, since the new Hamiltonian remains integrable, the explosion merely manifests itself by the appearance of second generation tori (Figure 2). The latter are confined to an interval  $\Delta J_1$  near  $J_1^0$  of the action axis of the non-perturbed Hamiltonian, given by

$$\Delta J_1 \sim \varepsilon H_{n_1 n_2}^c(J_1^0, J_2^0) / [n_1 \Omega_1(J_1^0, J_2^0) + n_2 \Omega_2(J_1^0, J_2^0)], \tag{31}$$

as flows from the equation of motion.

Suppose next that the Fourier series involves two factors  $H_{n_1 n_2}^c$  and  $H_{n'_1 n'_2}^c$ , all other expansion factors being zero. The second factor  $H_{n'_1 n'_2}^c$ , will then play a non-negligible part on a torus  $J_1'^0$  over which  $n'_1 \Omega_1(J_1'^0, J_2^0) + n'_2 \Omega_2(J_1'^0, J_2^0)$  becomes small; this torus suffers the same fate as torus  $J_1^0$ ; it breaks up into subtori covering again an interval  $\Delta J_1'$ , (given by a relation of type 31) provided that both unperturbed tori  $J_1^0, J_1'^0$  were sufficiently far away from each other; under those conditions each resonance each resonance acts as if it existed alone.

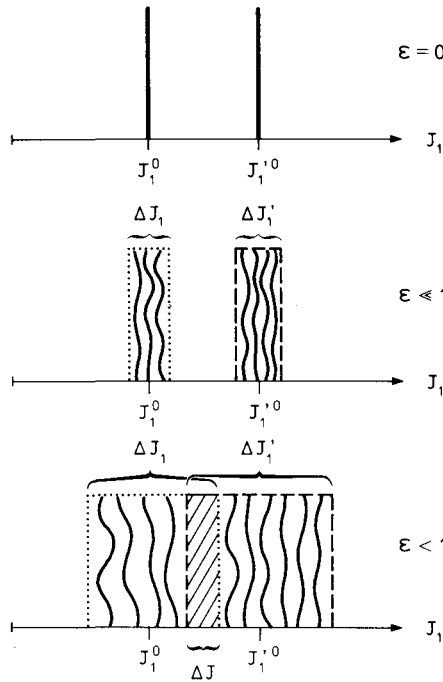

Fig. 2. Action of a non-integrable perturbation on two nearby resonant tori at positions  $J_1^0$  and  $J_1'^0$  in the energy box; the wavy area is populated by Kolmogorov tori; the shaded overlapping area lodges the Kolmogorov unstable orbits.

If however the exploded tori overlap (shaded area in Figure 2) the previous argument breaks down; within the region of overlapping resonances the integrability property is essentially lost. Empirically one observes that the condition

$$|J_1^0 - J_1'^0| \sim \frac{1}{2} |\Delta J_1 + \Delta J_1'| \tag{32}$$

approximately determines the onset of stochasticity (cf. Walker and Ford, 1969). The width  $\Delta J_1$  of an exploded torus increases with  $\varepsilon$ , or equivalently with the energy fed into

the oscillation; the existence of a threshold energy  $E_T$  in Hénon and Heiles's experiments then follows directly from the condition of overlap (32).

Numerical experiments on the effect of a nonlinear coupling of 3 harmonic oscillators of linear frequencies  $\omega_1 : \omega_2 : \omega_3 = 1 : 2 : 3$  have been performed by Ford and Lunsford (1971). Their experiments suggest that under this multiple resonance the threshold energy for stochasticity is arbitrarily small. This observation is compatible with the concept of overlapping resonances: the contributions

$$H_{3,0,-1} \cos(3\phi_1 - \phi_3) + H_{2,1,0} \cos(2\phi_1 - \phi_2)$$

in the Fourier expansion of the perturbed Hamiltonian simultaneously lead to small divisors for  $\varepsilon \rightarrow 0$  (or at zero energy).

(3) If a large number  $F$  of harmonic oscillations are interacting, the eventual distribution of energy over these oscillators becomes an important issue. Fermi, Pasta and Ulam (1955) in an experiment in which harmonic oscillators are coupled to simulate a non-linear string, find that the motions remain quasi-periodic, and that no significant energy exchange takes place. Ford (1961) emphasises that their negative result is a consequence of the lack of approximate resonances among the lower order linear frequencies of the string\*. Repeating a modified version of this experiment in which the frequencies of the harmonic oscillators are chosen to satisfy resonance conditions, Ford and Waters (1963) observe a relaxation towards thermalization of their oscillators: eventually the time interval over which any oscillator of the system has an energy between  $E$  and  $E + dE$  obeys a Boltzmann law.

Another variant of the Fermi–Pasta–Ulam experiment is due to Hirooka and Saitô (1969). These authors analyse a 2-dimensional lattice of oscillators, simulating non-linear oscillations of membranes. Under those conditions approximate resonances arise automatically. If a resonant linear oscillator is excited, the energy first remains trapped by this mode during an 'induction period'; then this mode decays and an eventual tendency towards equipartition is observed.

In the light of the heuristic information of the present section, the rigorous results (A) and (B) (Section 3) on the behaviour of adiabatic non-linear radial stellar oscillations can be specified further:

(A') If a sufficiently high amount of oscillation energy is fed into the lower oscillation modes (violation of KAM through a high factor  $\varepsilon$ ), the width of the ever present exploded tori (Equation (31)) can become appreciable, so that an overlapping of neighbouring exploded tori can take place. Therefore, Kolmogorov unstable oscillations are expected to occur among the lowest modes, provided that the energy input is large enough. The experiments discussed under (3) then suggest that an efficient diffusion of the oscillation energy towards higher modes should take place.

The phenomenon of enhanced energy diffusion among the stellar modes in the presence of non-linear resonance effects has actually been observed by Papaloizou (1973a, b)

\* In the Fermi–Pasta–Ulam experiments lowest order modes alone had initially been excited; Izrailev and Chirikov (1966) point out that an initial excitation of sufficiently high modes would have favoured the occurrence of stochastic motions.



(B') If one or several neighbouring asymptotic modes are initially excited, the quasi-resonances (28') imply that an overlap of exploded tori can occur at a very low threshold. Kolmogorov unstable oscillations should then be the rule rather than the exception. From the experiments listed under (1) one expects a power spectrum with a sequence of overlapping bands at the asymptotic frequencies  $1 \sim \omega_{N+1}, \omega_{N+1} \sim \omega_{N+2}, \dots, \omega_{N+n} \sim \omega_{N+n+1}, \dots$  (in relative units  $\omega_N = 1$ ) possibly merging into one very broad band; moreover, near the origin a single broad peak should appear, due to the second order resonances

$$\omega_{\text{res}} \sim \omega_{N+n+1} - \omega_{N+n} = \frac{1}{N} + O\left(\frac{1}{N^2}\right), \quad n = 0, 1, 2 \dots; \tag{33}$$

in absolute units  $\omega_{\text{res}} = \Omega_a + O(1/N)$ ; cf. Equation (28).

The surprising observation is that each asymptotic neighbouring pair of energised modes provides a power contribution at essentially the same frequency (33). The power spectrum of such a motion is then expected to show a conspicuous band peaked near the origin and joining a low level very broad band.

### 5. Numerical Experiments on Nonlinear Oscillations in Stars

This section is intended to demonstrate that the mathematical conclusions (A) and (B) as well as the informed guesses (A') and (B') do in fact hold in the stellar context. Moreover, we wish to get a quantitative idea of the orders of magnitude of the amplitude of the surface displacement under which the Kolmogorov instability sets in. We are also interested in the specific form of the time-behaviour of the surface displacement as well as of its power spectrum in this instability regime.

The numerical analysis is performed in the framework of the standard polytrope of index  $n = 3$ . Since this model is fairly representative for a whole class of stars, our conclusions are hoped to be 'typical' for stellar oscillations.

We shall briefly report here on just a few experiments. Technical details and a variety of numerical illustrations will be published elsewhere (Perdang and Blacher, 1982a, b).

In all our calculations the power series of the oscillation Hamiltonian (Equations (8), (8')) was terminated after the cubic interaction  $V^{(3)}$ . The numerical analysis was then carried through as if this truncated expansion represented the exact Hamiltonian.

#### 2-MODE INTERACTION

For any pair  $(i, j)$  among the lowest radial modes  $(i, j = 0, 1, \dots, 9)$  (0: fundamental; 1: first harmonic; ...) the equipotential curves (cf. Equation (8))

$$\begin{aligned} V(q_i, q_j) &= \frac{1}{2!} \sum_{k=i,j} (\omega_k^2 q_k^2 + p_k^2) + \frac{1}{3!} \sum_{k,l,m=i,j} V_{klm} q_k q_l q_m \\ &= v = e^{st} \end{aligned} \tag{34}$$



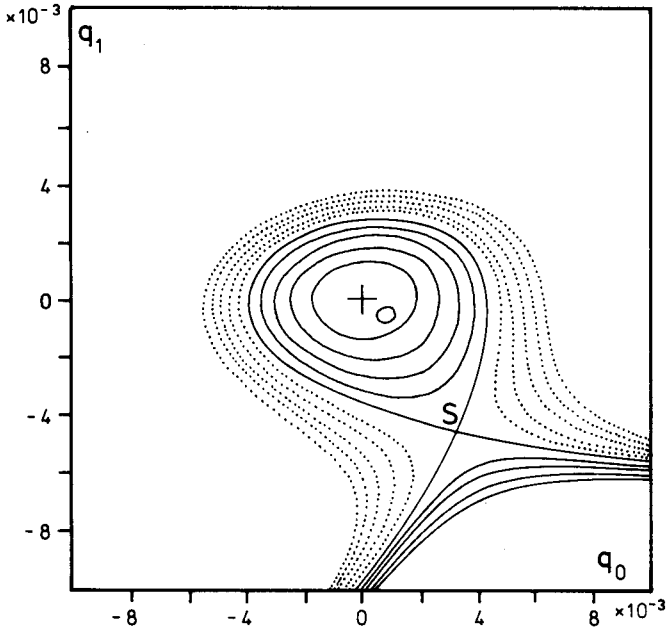

Fig. 3. Shape of the equipotential surface  $V = c^{st}$  for the fundamental mode – first harmonic coupling.

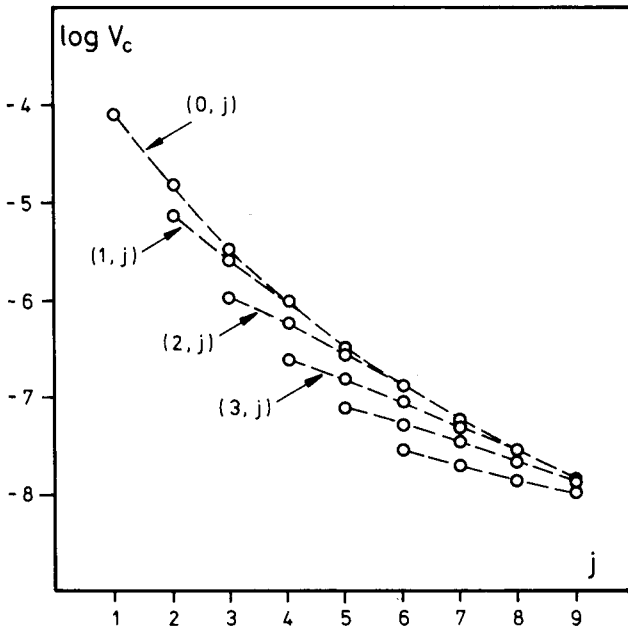

Fig. 4. Escape energy  $v_c$  for  $(i, j)$  couplings ( $v_c$  in units  $GM^2/R$ ).

in the neighbourhood of the stable state  $0$  ( $q_i = q_j = 0$ ) of the  $q_i, q_j$  plane have the typical form shown in Figure 3. For low values of  $v$  the curves are elliptical; they remain closed for  $0 < v < v_c$ , where  $v_c$  is a critical value such that the equipotential  $V(q_i, q_j) = v_c$  goes through a saddle point  $S$  of the energy surface; for  $v > v_c$ , the equipotentials become open curves in the neighbourhood of the stable equilibrium. The value  $v_c$  thus defines an escape energy, just as in the Hénon–Heiles oscillator. The shape of this potential well of non-linear two-mode interactions in stellar oscillations shows that the latter are mechanically modelled by the motion of a marble in a sauce-boat.

Figure 3 refers to the  $(0, 1)$  coupling; in the  $(0, j)$  coupling  $j = 2, 3, \dots$  the potential surface becomes steeper in the  $q_j$ -direction with increasing  $j$  values, while the saddle point  $S$  shifts towards the origin and towards the  $q_j$ -axis. The critical energy  $v_c$  decreases rapidly with  $j$  (cf. Figure 4). Since in the Hénon–Heiles experiment the threshold  $E_T = O(v_c) < v_c$ , we expect that in the stellar case Kolmogorov instability takes place at a threshold close to  $v_c$ . Figure 4 then leads us to conjecture that the threshold energy decreases rapidly with the orders  $(i, j)$  of the coupled modes; if it is allowed to extrapolate this diagram into the asymptotic range, the coupling  $(N, N + 1)$  generates Kolmogorov instability at an arbitrarily small threshold, provided that  $N$  is large enough.

In the  $(0, 1)$  coupling the frequencies are non-resonant ( $\omega_1/\omega_0 = 1.355$ ). From result (A) we know that the oscillations remain regular at low oscillation energy  $E \ll v_c$ . At sufficiently high energy a Kolmogorov instability is suspected to set in (A'). In fact at the oscillation energy  $E = v_c$  a large fraction of the energy manifold is numerically found to carry unstable motions; Kolmogorov instability of these solutions has been established via the standard method of the surface of section: the sequence of successive intersection points of the same orbit in the energy manifold covers a finite *area* on the surface of section (instead of a *curve*).

Figure 5 exhibits an example of such a solution. We display:

(a) the relative stellar surface displacement

$$\delta r/R = \xi_0 q_0 + \xi_1 q_1 \quad (|\delta r|/R < 0.5) \quad (35)$$

( $\xi_0 = 23.2$ ;  $\xi_1 = -87.7$ : surface values of the linear eigenfunctions under the normalisation (6); the maximum allowed  $q_0$  and  $q_1$ -values are given by the coordinates of the saddle point; hence the inequality);

(b) a lower resolution power spectrum of  $\delta r/R$  (integration time  $T = 819.2$  in units  $\omega_0 = 1$ ); and

(c) a high resolution spectrum of the low-frequency range ( $T' = 8T$ ).

The time behaviour clearly reveals several pseudo-periods which manifest themselves in the spectrum as bands around the (slightly shifted) linear frequencies  $\omega_0, \omega_1, \omega_0 + \omega_1, \omega_1 - \omega_0$ . An observer would presumably take spectrum (b) as evidence for exact periods, especially if his resolution is still poorer (note that here  $T \sim 130$

---

Fig. 5. Two-mode interaction  $(0, 1)$ : (a) time-behaviour of a Kolmogorov unstable surface displacement  $\delta r/R$ ; (b) corresponding power spectrum at lower resolution; (c) low-frequency end of the power spectrum at high resolution.

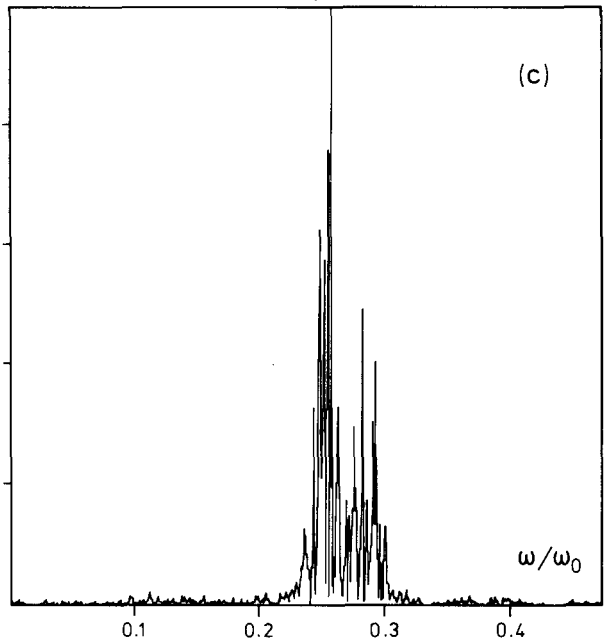
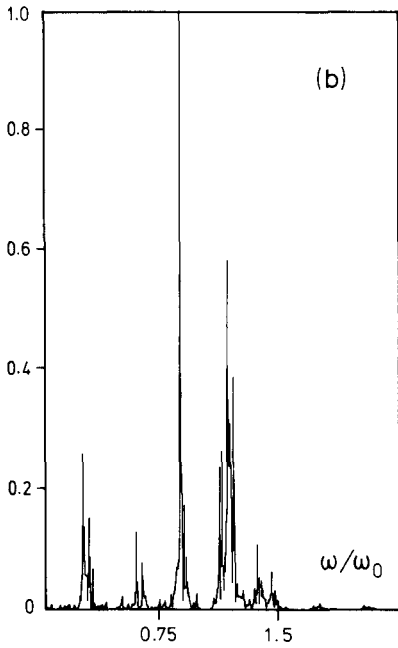
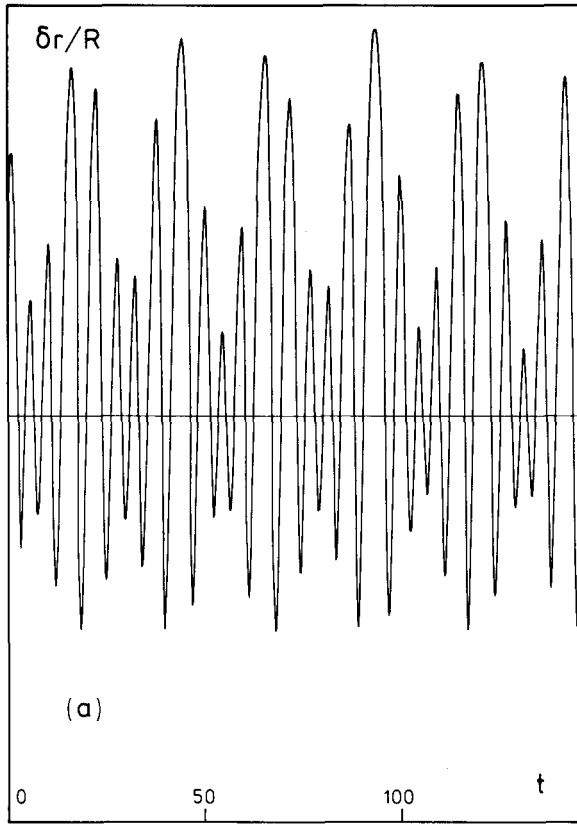

fundamental mode periods). Near the origin we have no conspicuous band (cf. (c)) due to the lack of an approximate resonance of order 2 in the linear frequencies; the broad band around  $0.3 \omega_0$  is however reminiscent of the power spectra of Hénon–Heiles stochastic oscillations (Blacher and Perdang, 1981a).

The relative surface amplitude under which these Kolmogorov unstable oscillations occur is close to 0.5 (cf. Equation (35)), so that a (0, 1) instability is not a common phenomenon in real stars.

In the (8, 9) *coupling* the frequencies are closer to a resonance of order 2 ( $\omega_9/\omega_8 = 1.098$ ). This coupling is selected to provide us some insight into the effect of 2-mode interactions in the asymptotic regime. Stochastic oscillations are now encountered at an energy  $\sim 0.9 v_c$  (hence  $E_T \lesssim 0.9 v_c$ ). The surface amplitude for these motions obeys  $|\delta r/R| < 0.08$  ( $\xi_8 = 5.7 \times 10^3$ ,  $\xi_9 = -7.8 \times 10^3$ ). The Kolmogorov instability in the (8, 9) coupling is thus found to occur at an amplitude level 6 times lower than in the (0, 1) coupling. In Figure 6 we illustrate the typical features of such a stochastic solution. The time-run (a) shows a conspicuous pseudo-period  $P \sim 9$  (units  $\omega_8 = 1$ ) which shows up as a broad band in spectrum (b) ( $T = 819.2$  in units  $\omega_8 = 1$ ). In the high resolution spectrum (c) ( $T' = 8T$ ) an additional band near the origin does materialise, as expected (B'). The general shape of this latter spectrum already bears some analogy with the structure of the SCLERA solar spectra.

A tentative extrapolation of the previous figures suggests that for modes of asymptotic order around 100, the relative surface amplitude level for stochasticity is  $\sim 10^{-3}$ .

### MULTIPLE-MODE INTERACTION

The equipotential surfaces for a coupling ( $i_1, i_2, \dots, i_F$ ) between  $F (> 2)$  linear modes  $i_1, i_2, \dots, i_F$  in the neighbourhood of the stable equilibrium state  $0(q_{i_1} = q_{i_2} = \dots q_{i_F} = 0)$  are again given by an expression of form (34) where  $k, l$ , and  $m$  are now ranging over  $i_1, i_2, \dots, i_F$ . For  $V(q_{i_1}, q_{i_2}, \dots, q_{i_F}) = v < v_c$  these surfaces are closed; for  $V = v > v_c$  they become open; the critical surface  $V = v_c$  possesses a multiple point  $S$ . A motion of energy less than  $v_c$  remains bounded; if its energy exceeds  $v_c$  it can escape; it is however worth noting that the time interval over which an orbit remains trapped in a potential pocket at energy  $v > v_c$  increases sharply with  $F$  (Perdang and Blacher, 1982b).

In the (0, 1, 2, 3)-*coupling* the linear frequencies obey  $\omega_0 : \omega_1 : \omega_2 : \omega_3 = 1 : 1.35 : 1.75 : 2.17$ , so that we have no approximate low order ( $\leq 4$ ) resonances among these frequencies. Therefore stochastic motions are not expected to occur at a threshold energy significantly lower than  $v_c$ .

At the critical energy  $v_c$  Kolmogorov instability is again observed. Figure 7 provides an example of the relative surface displacement

$$\begin{aligned} \delta r/R &= \xi_0 q_0 + \xi_1 q_1 + \xi_2 q_2 + \xi_3 q_3 \\ (\xi_2 &= 2.36 \times 10^2, \quad \xi_3 = -5.21 \times 10^2). \end{aligned} \tag{36}$$

Two pseudo-periods show clearly up in the time run (a), a periodicity  $\sim 3.5$  (in units  $\omega_0 = 1$ ) and a beat periodicity  $\sim 20$ ; they correspond to the highest broadened peaks

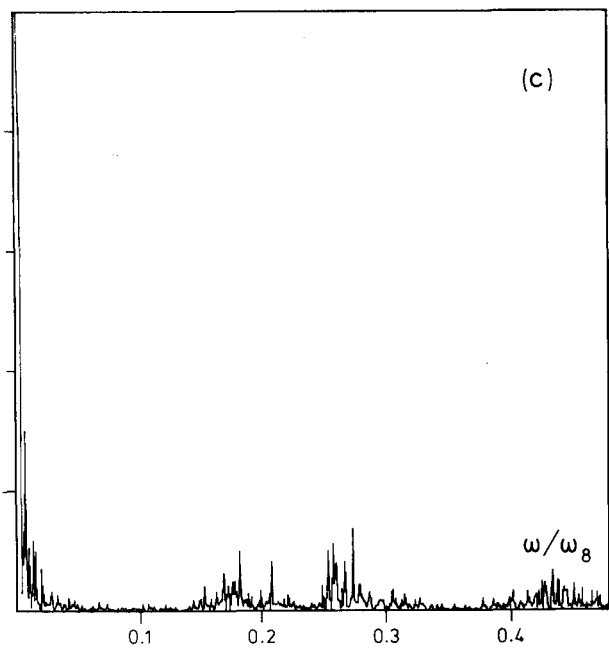
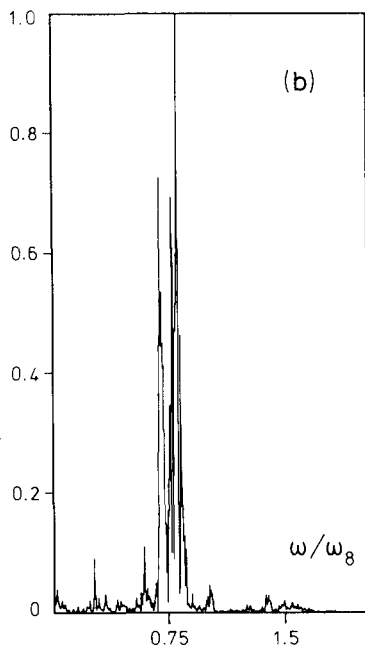
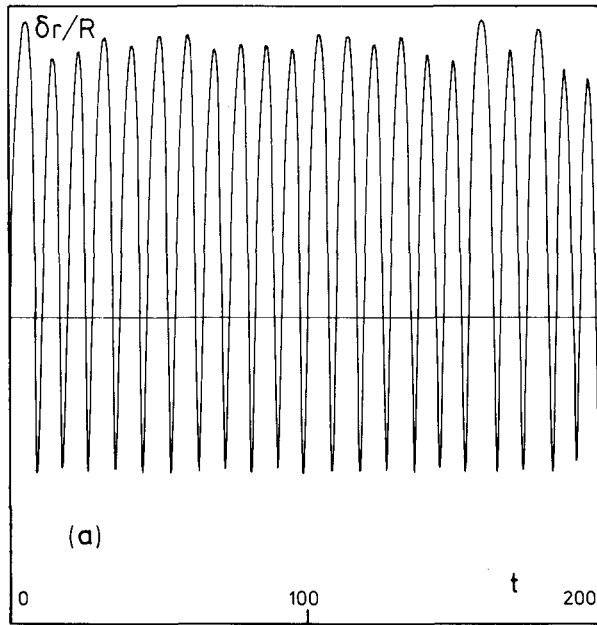

Fig. 6. Two-mode interaction (8, 9): (a) time behaviour of a Kolmogorov unstable surface displacement  $\delta r/R$ ; (b) corresponding lower resolution power spectrum; (c) low-frequency end at higher resolution.

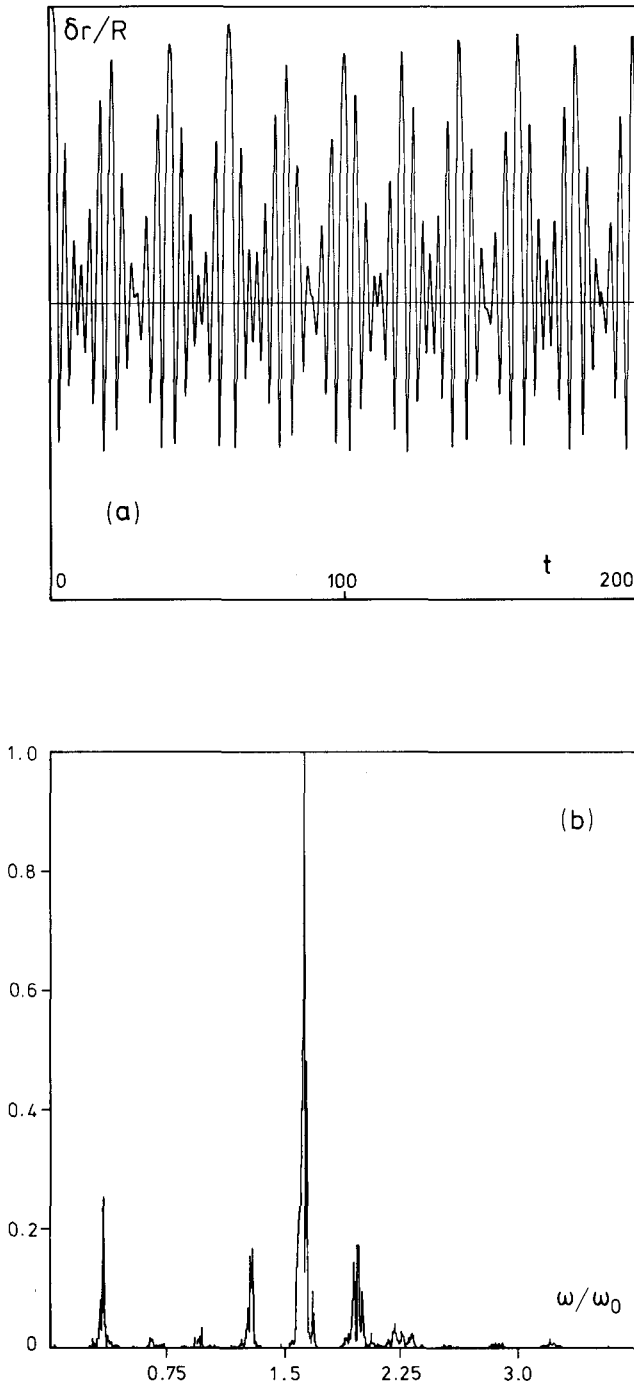

Fig. 7. Four-mode interaction (0, 1, 2, 3): (a) Kolmogorov unstable surface displacement  $\delta r/R$ ; and (b) corresponding lower resolution power spectrum.

of the power spectrum (b) ( $T = 819.2$ ). At low resolution, say  $T'' \sim \frac{1}{4}T$ , the broadened peaks in (b) appear as fine lines; such a spectrum would mistakenly be interpreted as being due to harmonic, or quasi-periodic motions (cf. Equations (11''), (11''')). At high resolution ( $T'' = 8T$ ) each peak appears as a broad structured band analogous to the feature shown in Figure 5c. The fractal dimensions of all bands in the power spectra analysed are found to lie in the range  $1.3 \lesssim d \lesssim 1.5$ .

## 6. Conclusion and Outlook

The main result of the present analysis is the numerical proof that stellar adiabatic radial motions about a dynamically stable equilibrium state can exhibit the Kolmogorov instability. While in lower order mode couplings large surface displacements are required to produce this instability ( $|\delta r|/R \sim 0.5$  for the (0, 1) coupling), the amplitude of the surface displacements decreases steadily with the orders of the coupled modes, so that in the asymptotic frequency range this instability can set in fairly easily.

It is thought – although this point remains to be proved in the stellar context – that the physically most relevant role of this instability is to secure an efficient energy transfer between all modes, which eventually leads to an equipartition of oscillation energy between all coupled degrees of freedom. If this conjecture holds a statistical approach to the distribution of the surface amplitudes as a function of frequency becomes meaningful under such stochasticity conditions. We might add that following remark (B') one has to expect then a very broad-band asymptotic spectrum, due to the blown up and overlapping linear asymptotic frequency peaks at  $\omega_N, \omega_{N+1}, \dots$ , together with an intrinsically non-linear component, namely a band centred at the zero-frequency (or perhaps closer to the frequency  $\omega_{\text{res}}$ ; cf. Equation (33)), resulting from a piling up of power at the quasi-resonance of order 2; presumably, similar bands related to higher order resonances will appear, centered at about  $2\omega_{\text{res}}, 3\omega_{\text{res}}, \dots$  whose heights are rapidly decreasing with order; the overlapping of these bands gives the power spectrum the characteristic structure of '1/f-noise' in the low frequency region.

The readymade exploratory analysis of this paper pertains to all approximately adiabatic stellar oscillation phenomena. Obviously each specific type of variability requires a tailor-made application of the theory. This is in particular so in the context of solar oscillations: since observation reveals non-radial motions, an extension of the present formalism to the non-radial case is needed. The very fact that a Hamiltonian formalism continues to hold means that the main theoretical conclusions (A and B) survive with however several modifications.

Resonances and approximate resonances are much more likely to occur among the non-radial modes than among the radial ones just as they are more probable in a membrane than in a string. In fact we now have 3 distinct types of resonance:

(1) A  $(2l + 1)$ -fold degeneracy, due to the radial symmetry of the equilibrium state, for any frequency (acoustic or gravity mode) of degree  $l \neq 0$ ; hence we have an infinity of exact resonances of order 2; provided that the potential is such that eigenfunctions  $\xi_{k,l,m}$  of same radial order  $k$  and same degree  $l$  but of different azimuthal number  $m$

become coupled in the non-linear regime then these resonances favour the Kolmogorov instability; (surface amplitudes lower than in the radial oscillations will be required for this instability to set in).

(2) Sharp resonances of order 2 are known to occur among gravity modes associated with two nearby radiative zones separated by a convective shell (cf. Ledoux and Perdang, 1980).

(3) From the representation formula for acoustic frequencies of asymptotically large radial order  $k = N$  and low degree  $l$  one has

$$(N \rightarrow \infty): \quad \omega_{N,l} = \omega_{N-1,l+2} + O(1/N^2) \quad (37)$$

(cf. Christensen-Dalsgaard and Gough, 1980, for an estimate of the accuracy of this relation in the context of the Sun) so that a quasi-resonance much tighter than for adjacent radial asymptotic modes obtains.

It seems therefore reasonable that in the same asymptotic range the onset of Kolmogorov unstable non-radial oscillations will occur at a very much lower amplitude level than for radial oscillations. Unfortunately, since the interaction potential for non-radial modes, and in particular the location of its critical point closest to the origin is unknown, we are not in a position to make any quantitative estimate of the surface amplitude needed to generate such stochastic oscillations. In any event, if the acoustic oscillations are Kolmogorov unstable, one expects a power spectrum of the surface displacement with a  $1/f$ -noise shape near the frequency origin, which should extend over several times the resonance frequency  $\omega_{\text{res}}$ ; the tail of this distribution joins a wide band of broadened overlapping pseudo-linear asymptotic frequency peaks (pseudo-linear in the sense that their centres are slightly shifted towards the left by the coupling effect).

For currently favoured solar models the second order resonance frequency  $\omega_{\text{res}} \simeq 0.136$  mHz (Christensen-Dalsgaard and Gough, 1980); this amounts to a periodicity slightly in excess of 2hr.

The SCLERA solar power spectra have an overall structure in agreement with the theoretically expected shape of a Kolmogorov unstable power spectrum. This is indicative that a detailed numerical investigation of non-linear non-radial acoustic mode couplings is needed before a convincing identification of the peaks can be performed.

### Acknowledgements

This paper was completed during a stay at the Institute of Astronomy, Cambridge. The author wishes to thank the members of this institution for the hospitality extended to him. He is particularly indebted to Douglas Gough who presented this paper at the 66th IAU Colloquium. He gratefully acknowledges a NATO travel grant through the Luxembourg Ministère de l'Éducation Nationale.

### References

- Arnold, V. I.: 1963a, *Russian Math. Surveys* **18** (6), 85.  
 Arnold, V. I.: 1963b, *Russian Math. Surveys* **18** (5), 9.  
 Arnold, V. I.: 1976, *Méthodes Mathématiques de la Mécanique Classique*, éd. Mir Moscow, App. 7.



- Birkhoff, G. D.: 1927, *Dynamical Systems*, American Mathematical Society, Providence, Rhode Island (Revised edition by J. Moser, 1966).
- Blacher, S. and Perdang, J.: 1981a, *Physica* **3D**, 512.
- Blacher, S. and Perdang, J.: 1981b, *Monthly Notices Roy. Astron. Soc.* **19**, 109 P.
- Brown, T. M., Stebbins, R. T., and Hill, H. A.: 1978, *Astrophys. J.* **223**, 324.
- Chirikov, B.: 1979, *Physics Reports* **52**, 265.
- Christensen-Dalsgaard, J. and Gough, D. O.: 1980, *Nature* **288**, 544.
- Demaret, J., Dzuba, V., and Perdang, J.: 1978, *Astron. Astrophys.* **70**, 287.
- Fermi, E., Pasta, J., and Ulam, S.: 1955, Los Alamos Scientific Laboratory Report LA-1940.
- Ford, J.: 1961, *J. Math. Phys.* **2**, 387.
- Ford, J. and Lunsford, G. H.: 1971, *Phys. Rev.* **A1**, 59.
- Ford, J., and Waters, J.: 1963, *J. Math. Phys.* **4**, 1293.
- Hénon, M. and Heiles, C.: 1964, *Astron. J.* **69**, 73.
- Hirooka, H. and Saitô, N.: 1969, *J. Phys. Soc. Japan* **26**, 624.
- Izrailev, F. M. and Chirikov, B. V.: 1966, *Soviet Phys. Dokl.* **11**, 30.
- Kolmogorov, A. N.: 1957, 'Théorie Générale des Systèmes Dynamiques et Mécanique Classique', Proc. Int. Congress of Math., Amsterdam (Appendix D in R. Abraham, 1967, *Foundation of Mechanics*, Benjamin, New York)
- Ledoux, P. and Perdang, J.: 1980, *Bull. Soc. Math. Belgique* **32**, 135.
- Moser, J.: 1962, *Nachr. der Akad. der Wissensch. in Göttingen Math.-Phys. Kl.*, 1.
- Moser, J.: 1973, *Stable and Random Motions in Dynamical Systems*, Princeton Univ. Press.
- Nekhoroshev, N. N.: 1977, *Russian Math. Surveys* **32** (6), 1.
- Noid, D. W., Koszykowski, M. L., and Marcus, R. A.: 1977, *J. Chem. Phys.* **67**, 404.
- Papaloizou, J. C. B.: 1973a, *Monthly Notices Roy. Astron. Soc.* **162**, 143.
- Papaloizou, J. C. B.: 1973b, *Monthly Notices Roy. Astron. Soc.* **162**, 169.
- Perdang, J.: 1981, *Astrophys. Space Sci.* **74**, 149.
- Perdang, J. and Blacher, S.: 1982a, *Astron. Astrophys.* **112**, 35.
- Perdang, J. and Blacher, S.: 1982b, in preparation.
- Poincaré, H.: 1890, *Acta Math.* **13**, 1.
- Poincaré, H.: 1912, *Rendic. Circ. Mat. Palermo* **33**, 375.
- Powell, G. E. and Percival, I. C.: 1979, *J. Phys. A.: Math. Gen.* **12**, 2053.
- Rosseland, S.: 1949, *The Pulsation Theory of Variable Stars*, Clarendon Press, Oxford, Sections 4.3, 4.4, 4.5; Chapter 7.
- Siegel, C. L.: 1954, *Math. Ann.* **128**, 144.
- Simon, N.: 1972, *Astron. Astrophys.* **21**, 45.
- Walker, G. H. and Ford, J.: 1969, *Phys. Rev.* **188**, 416.
- Woltjer, J.: 1935, *Monthly Notices Roy. Astron. Soc.* **95**, 260.
- Woltjer, J.: 1937, *Bull. Astron. Inst. Netherlands* **8**, 193.
- Woltjer, J.: 1943, *Bull. Astron. Inst. Netherlands* **9**, 435.
- Zaslavskii, G. M. and Chirikov, B. V.: 1971, *Soviet Physics Uspekhi* **14**, 549.