

Volume 22, Number 4

August 2016

# Microscopy AND Microanalysis



CAMBRIDGE  
UNIVERSITY PRESS

ISSN 1431-9276

# EMS has it!

## GloQube™

### Glow Discharge System for TEM Grids

- Dual or single chamber
- Hydrophilic/hydrophobic and negative/positive modes
- Fully automatic, short process times
- Intuitive touch screen control
- Safe vapor delivery using septum-sealed vials
- Automatic valving between chambers to prevent cross-contamination
- Quick and easy sample loading
- Controlled venting to prevent sample disturbance
- Consistent, reliable results
- Three-year warranty

Automatic operation - during timed glow discharge

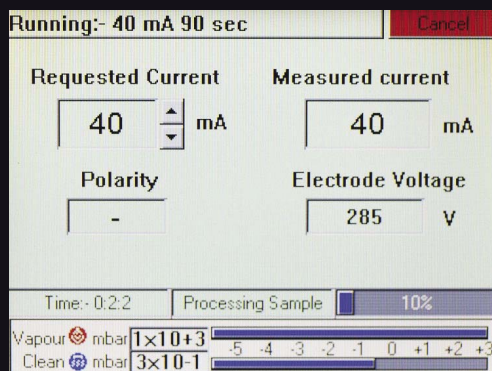

Introducing...

# GloQube™

Glow Discharge System for TEM Grids



GloQube-D

## rapid, reliable glow discharge...

The GloQube™ is a compact, easy-to-use glow discharge system primarily used for the hydrophilization (wetting) of TEM support films and grids. Other applications include surface modifications, for example, for enhancing polymer bonding.

The GloQube™ is available in two formats. The GloQube-D has two independent vacuum chambers: a clean chamber for applications requiring hydrophobic/hydrophilic conversion and a vapor chamber designed for hydrophilic/hydrophobic (negative or positive) conversions. The GloQube-S has a single clean chamber.

CONTACT US FOR  
MORE INFORMATION...

**Electron  
Microscopy  
Sciences**

P.O. Box 550 • 1560 Industry Rd.  
Hatfield, Pa 19440

Tel: (215) 412-8400

Fax: (215) 412-8450

email: sgkcck@aol.com

or stacie@ems-secure.com

[www.emsdiasum.com](http://www.emsdiasum.com)

Clean Chamber



Vapor Chamber



---

# Microscopy AND Microanalysis

An International Journal for the Biological and Physical Sciences

---

THE OFFICIAL JOURNAL OF

MICROSCOPY SOCIETY OF AMERICA  
MICROANALYSIS SOCIETY  
MICROSCOPICAL SOCIETY OF CANADA /  
SOCIÉTÉ DE MICROSCOPIE DU CANADA  
MEXICAN MICROSCOPY SOCIETY  
BRAZILIAN SOCIETY FOR MICROSCOPY AND MICROANALYSIS  
VENEZUELAN SOCIETY OF ELECTRON MICROSCOPY  
EUROPEAN MICROBEAM ANALYSIS SOCIETY  
AUSTRALIAN MICROSCOPY AND MICROANALYSIS SOCIETY  
PORTUGUESE SOCIETY FOR MICROSCOPY

PUBLISHED IN AFFILIATION WITH

ROYAL MICROSCOPICAL SOCIETY  
GERMAN SOCIETY FOR ELECTRON MICROSCOPY  
BELGIAN SOCIETY FOR MICROSCOPY  
MICROSCOPY SOCIETY OF SOUTHERN AFRICA

---

**Editor in Chief**

**Editor, Biological Applications**

Robert L. Price  
Cell and Developmental Biology and  
Anatomy  
University of South Carolina  
Columbia, SC 29209  
e-mail: Bob.Price@uscmed.sc.edu

**Editor, Materials Applications**

Grace Burke  
School of Materials  
The University of Manchester  
Manchester, UK  
e-mail: m.g.burke@manchester.ac.uk

**Editor, Scanning Probe  
Microscopies**

Andrew Magyar  
Center for Nanoscale Systems  
Harvard University  
Cambridge, MA 02138  
e-mail: amagyar@cns.fas.harvard.edu

**Editor, Atom Probe Tomography**

Brian P. Gorman  
Metallurgical and Materials Engineering  
Colorado Center for Advanced Ceramics  
Colorado School of Mines  
Golden, CO 80401  
Email: bgorman@mines.edu

**Editor, Biological Applications**

William A. Russin  
Biological Imaging Facility  
Department of Neurobiology  
Northwestern University  
Evanston, IL 60208  
e-mail: w-russin@northwestern.edu

**Editor, Biological Applications**

Heide Schatten  
Veterinary Pathobiology  
University of Missouri-Columbia  
Columbia, Missouri 65211-5030  
e-mail: schattenh@missouri.edu

**Editor, Microanalysis**

John Mansfield  
Electron Microbeam Analysis Lab  
North Campus, 417 SRB  
University of Michigan  
Ann Arbor, MI 48109-2143  
e-mail: jfmjfm@umich.edu

**Editor, Correlative and Emerging  
Microscopy Applications**

Vinayak P. Dravid  
Materials Science and Engineering  
Northwestern University  
Evanston, Illinois 60208-3105  
e-mail: v-dravid@northwestern.edu

**Editor, Plant Biology Applications**

Rosemary White  
CSIRO Plant Industry  
Canberra, ACT 2601, Australia  
e-mail: rosemary.white@csiro.au

**Special Issues and Reviews Editor**

Jay Jerome  
Vanderbilt University Medical Center  
Nashville, TN 37232  
e-mail: jay.jerome@vanderbilt.edu

**Book Review Editor**

Cynthia S. Goldsmith  
Centers for Disease Control  
Atlanta, GA 30333  
e-mail: csg1@cdc.gov

**M&M Program Guide Editor**

Richard E. Edlmann  
Miami University  
Oxford, OH 45056  
e-mail: edelmare@muohio.edu

**Proceedings Editor**

Gail Celio  
University of Minnesota  
St. Paul, MN 55108  
e-mail: celio001@umn.edu

**Administrative Editor**

John Shields  
University of Georgia  
Athens, GA 30602  
e-mail: jpshield@uga.edu

---

## Editorial Board

Ralph Albrecht	<i>University of Wisconsin, Madison, Wisconsin</i>
Ilke Arslan	<i>Pacific Northwest Laboratory, Richland, Washington</i>
Barry Carter	<i>University of Connecticut, Storrs, Connecticut</i>
Wah Chiu	<i>Baylor College of Medicine, Houston, Texas</i>
Niels de Jonge	<i>INM Institute for New Materials, Saarbrücken, Germany</i>
Alberto Diaspro	<i>University of Genoa, Italy</i>
Elizabeth Dickey	<i>North Carolina State University, Raleigh</i>
Mark Ellisman	<i>University of California at San Diego, San Diego, California</i>
Pratibha Gai	<i>University of York, United Kingdom</i>
Marija Gajdardziska-Josifovska	<i>University of Wisconsin-Milwaukee, Milwaukee, Wisconsin</i>
Dale Johnson	<i>University of South Florida, Tampa, Florida</i>
Paul Kotula	<i>Sandia National Labs, Albuquerque, New Mexico</i>
William Landis	<i>University of Akron, Akron, Ohio</i>
Eric Lifshin	<i>SUNY at Albany, Albany, New York</i>
Charles Lyman	<i>Lehigh University, Bethlehem, Pennsylvania</i>
Dale Newbury	<i>National Institute of Standards and Technology, Gaithersburg, Maryland</i>
Jean-Paul Revel	<i>California Institute of Technology, Pasadena, California</i>
David Smith	<i>Arizona State University, Tempe, Arizona</i>
Nan Yao	<i>Princeton University, Princeton, New Jersey</i>
Nestor Zaluzec	<i>Argonne National Laboratory, Argonne, Illinois</i>

## Editorial Board Representatives from Affiliated Societies

Masashi Watanabe	<i>Lehigh University (MAS)</i>
Gautam Kumar Dey	<i>Bhabha Atomic Research Centre (EMSI)</i>
Gema Gonzalez	<i>Venezuelan Institute for Scientific Investigation (Venezuela)</i>
Michael Robertson	<i>Acadia University, Wolfville, Nova Scotia (Canada)</i>
Brendan Griffin	<i>University of Western Australia (AMMS)</i>
Guillermo Solorzano	<i>Pontificia Universidade Catolica, Rio de Janeiro (Brazil)</i>
Mike Matthews	<i>Atomic Weapons Establishment, Reading, Great Britain (EMAS)</i>
Miguel Yacamán	<i>Mexico Institute for Nuclear Research (Mexico)</i>
Henrique Almeida	<i>Universidade do Porto (Portugal)</i>

## Founding Editor

Jean-Paul Revel	<i>California Institute of Technology, Pasadena, California</i>
-----------------	---

## Previous Editors-in-Chief

Dale Johnson	<i>University of South Florida, Tampa, Florida</i>
Charles Lyman	<i>Lehigh University, Bethlehem, Pennsylvania</i>

This journal is part of the **Cambridge Journals Online** service. Access to online tables of contents and article abstracts is available to all researchers at no cost. Access to full-text articles online is provided to those with online subscription. Online subscriptions must be activated. Once your subscription is activated, free access to past, present, and forthcoming articles is available at:

***Microscopy and Microanalysis* website: [journals.cambridge.org/MAM](http://journals.cambridge.org/MAM).**

Instructions for authors submitting manuscripts may be found at [journals.cambridge.org/MAM](http://journals.cambridge.org/MAM). Select "Further Information" then select "Instructions for Contributors." An abbreviated version of these instructions will be published in the first issue (February) of each volume.

# however you look at it...

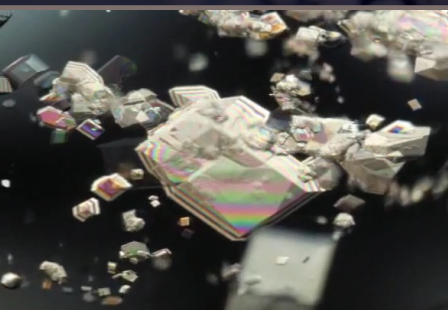

**DIGITAL 3D...**

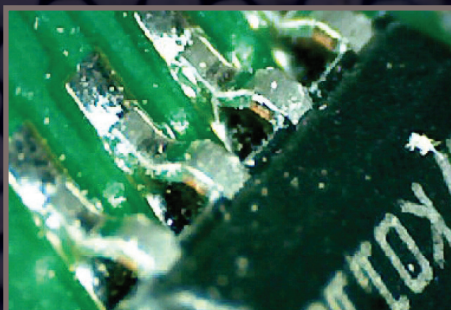

**DIGITAL WI-FI...**

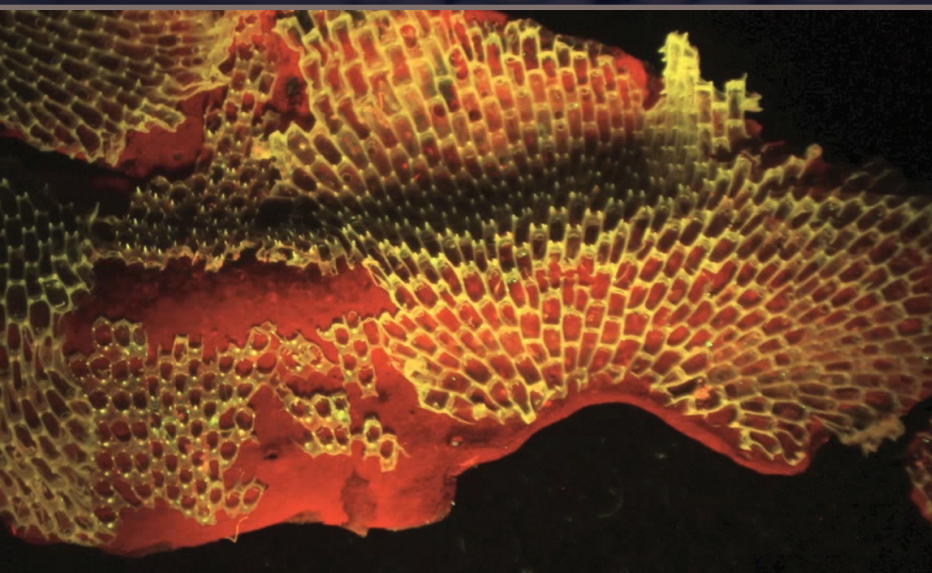

**FLUORESCENCE-ADAPTED...**

# ...EMS has it!

**CONTACT US FOR MORE INFORMATION...**

**Electron  
Microscopy  
Sciences**

P.O. Box 550 • 1560 Industry Rd.  
Hatfield, Pa 19440  
Tel: (215) 412-8400  
Fax: (215) 412-8450  
email: [sgkcck@aol.com](mailto:sgkcck@aol.com)  
or [stacie@ems-secure.com](mailto:stacie@ems-secure.com)

[www.emsdiasum.com](http://www.emsdiasum.com)

<https://doi.org/10.1017/S1431927616011533>

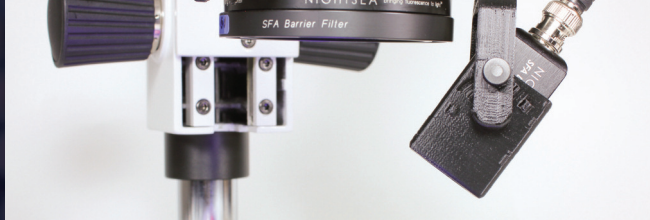

**MORE GLOW FOR THE DOUGH**

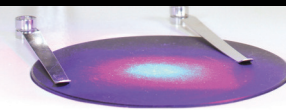

## NIGHTSEA™ Fluorescence Viewing Systems

- ▶ Quick screening and sorting of your fluorescent genotypes
- ▶ Fluorescence-aided dissection, injection, or micromanipulation
- ▶ Free up your research-grade fluorescence microscopes for more demanding work
- ▶ Installs in seconds - just clicks into place

*Full brochure available, contact us for more information.*

**VERSATILE & PORTABLE**

## Mic-Fi Digital Wi-Fi Microscopes

Easily realize the following functions: measurement, conservation, copy and transfer of images and video, which are difficult for a traditional microscope. They are small, easy to operate, light, and portable. They can be used with all the most popular smartphones, tablets and even PCs. This is the new state-of-the-art way to observe the micro-world!



*Full brochure available, contact us for more information.*

**COST-EFFECTIVE 3D IMAGING**

## Edge® Digital 3D Micro/Macroscopes

- ▶ Fully automated 3D imaging
- ▶ Plug & play and user friendly
- ▶ Breakthrough value

*Full brochure available, contact us for more information.*



*Microscopy and Microanalysis* publishes original research papers dealing with a broad range of topics in microscopy and microanalysis. These include articles describing new techniques or instrumentation and their applications, as well as papers in which established methods of microscopy or microanalysis are applied to important problems in the fields of biology or materials science. Microscopy and microanalysis are defined here in a broad sense, and include all current and developing approaches to the imaging and analysis of microstructure. The criteria for acceptance of manuscripts are the originality and significance of the research, the quality of the microscopy or microanalysis involved, and the interest for our readership.

Four types of communications are published in the Journal. **Regular Articles** are of substantial length and describe the findings of an original research project that satisfies the aims and scope of the Journal, described above. **Review Articles** summarize the current status of an important area within the aims and scope of the Journal. **Letters to the Editor** usually contain comments on recent articles that have appeared in the Journal. **Book Reviews** are also published, but these are solicited only through the Book Review Editor.

### Instructions for Contributors

Instructions for authors contributing manuscripts may be found at <http://mc.manuscriptcentral.com/mam> under "Resources: Instructions and Forms." Authors may also visit [http://www.journals.cambridge.org/jid\\_MAM](http://www.journals.cambridge.org/jid_MAM), select "Further Information," and then select "Instructions for Contributors." An abbreviated version of these instructions will be published in the first issue (February) of each volume.

### Copyright Information

Submission of a manuscript implies: that the work described has not been published before (except in the form of an abstract or as part of a published lecture, review, or thesis); that it is not under consideration for publication elsewhere; that its publication has been approved by all coauthors, if any, as well as by the responsible authorities at the institute where the work has been carried out; that, if and when the manuscript is accepted for publication, the authors agree to automatic transfer of the copyright to the Microscopy Society of America; that the manuscript will not be published elsewhere in any language without the consent of the copyright holders; and that written permission of the copyright holder is obtained by the authors for material used from other copyrighted sources.

All articles published in this journal are protected by copyright, which covers the exclusive rights to reproduce and distribute the article (e.g., as offprints), as well as all translation rights. No material published in this journal may be reproduced photographically or stored on microfilm, in electronic data bases, video disks, etc., without first obtaining written permission from the publisher.

The use of general descriptive names, trade names, trademarks, etc., in this publication, even if not specifically identified, does not imply that these names lack protection by the relevant laws and regulation.

Authorization to photocopy items for internal or personal use, or the internal or personal use of specific clients, is granted by Cambridge University Press, provided that the appropriate fee is paid directly to Copyright Clearance Center, 222 Rosewood Drive, Danvers, MA 01923, USA (Tel: (508) 750-8400), stating the ISSN (1431-9276), the volume, and the first and last page numbers of each article copied. The copyright owner's consent does not include copying for general distribution, promotion, new works, or resale. In these cases, specific written permission must first be obtained from the publisher.

### Disclaimer

The Microscopy Society of America, the other societies stated, and Cambridge University Press cannot be held responsible for errors or for any consequences arising from the use of the information contained in this journal. The appearance of scientific reports and/or workshops, or any other material in *Microscopy and Microanalysis* does not constitute an endorsement or approval by The Microscopy Society of America of the findings, data, conclusions, recommendations, procedures, results, or any other aspect of the content of such articles. The appearance of advertising in *Microscopy and Microanalysis* does not constitute an

endorsement or approval by The Microscopy Society of America of the quality or value of the products advertised or any of the claims, data, conclusions, recommendations, procedures, results, or any other information included in the advertisements.

While the advice and information in this journal is believed to be true and accurate at the date of its going to press, neither the authors, the editors, nor the publisher can accept any legal responsibility for any errors or omissions that may be made.

### Subscription Information

*Microscopy and Microanalysis* is published bimonthly in February, April, June, August, October, and December by Cambridge University Press. Three supplements (*Meeting Guide*, *Program Guide*, and *Proceedings*) are published in June and August.

**Society Rates:** Members of the Microscopy Society of America should contact the MSA Business Office for all subscription inquiries: Microscopy Society of America, Hachero Hill, Inc., 11260 Roger Bacon Drive, Suite 402, Reston, VA 20190, Tel.: (703) 964-1240, Ext. 14, E-mail: [nicoleguy@mindspring.com](mailto:nicoleguy@mindspring.com), URL: [www.msa.microscopy.org](http://www.msa.microscopy.org). Members of other affiliated societies should contact their respective society business offices for all subscription inquiries.

**Subscription Rates:** Institutions print and electronic: US \$1876.00 in the USA, Canada, and Mexico; UK £1128.00 + VAT elsewhere. Institutions online only: US \$1327.00 in the USA, Canada, and Mexico; UK £803.00 + VAT elsewhere. Individuals print plus online: US \$548.00 in the USA, Canada, and Mexico; UK £333.00 + VAT elsewhere. Prices include postage and insurance.

**USA, Canada, and Mexico:** Subscribers in the USA, Canada, and Mexico should send their orders, with payment in US dollars or the equivalent value in Canadian dollars, to: Cambridge University Press, Customer Services Department (Journals), 32 Avenue of the Americas, New York, NY 10013, USA. Tel: (845) 353-7500. Fax: (845) 353-4141. Orders may be phoned direct (toll free): (800) 872-7423. E-mail: [journals\\_subscriptions@cup.org](mailto:journals_subscriptions@cup.org).

**Outside North America:** Subscribers elsewhere should send their orders, with payment in sterling, to: Customer Services Department (Journals), Cambridge University Press, The Edinburgh Building, Shaftesbury Road, Cambridge, CB2 8RU, UK. Tel: +44 (0)1223 326070. Fax: 44 (0)1223 325150. E-mail: [journals@cambridge.org](mailto:journals@cambridge.org)

**Change of address:** Allow six weeks for all changes to become effective. All communications should include both old and new addresses (with postal codes) and should be accompanied by a mailing label from a recent issue. Society members should contact their respective society business offices to inform them of address changes.

### Editorial Office

Robert L. Price, Editor in Chief, Department of Cell and Developmental Biology and Anatomy, School of Medicine, University of South Carolina, 6439 Garner's Ferry Road, Bldg. 1 B-60, Columbia, SC 29209, USA; Tel: (803) 216-3824; Fax: (803) 733-3212; E-mail: [Bob.Price@uscmed.sc.edu](mailto:Bob.Price@uscmed.sc.edu).

### Office of Publication

Cambridge University Press, 32 Avenue of the Americas, New York, NY 10013-2473, USA; Tel: (212) 337-5000; Fax: (212) 337-5959.

### Advertising Sales & Production

Kelly Miller, M.J. Mrvica Associates, Inc., 2 West Taunton Avenue, Berlin, NJ 08009, USA; Tel: (856) 768-9360; Fax: (856) 753-0064.

© 2016 by Microscopy Society of America. Printed in the United States on acid-free paper. Periodicals postage paid at New York, NY, and additional mailing offices. Return postage guaranteed. Postmaster: Send address changes in the U.S.A. and Canada to *Microscopy and Microanalysis*, Subscription Department, Cambridge University Press, 100 Brook Hill Drive, West Nyack, NY 10994-2133.

pco.

# on the cutting edge

pco.edge family

now with advanced sCMOS

image sensor

1.1  
GByte/s  
image data  
bandwidth

up to  
82%  
quantum  
efficiency

CAMERA  
**LinkHS**  
available



small  
form factor

[www.pco.de](http://www.pco.de)  
[www.pco-tech.com](http://www.pco-tech.com)

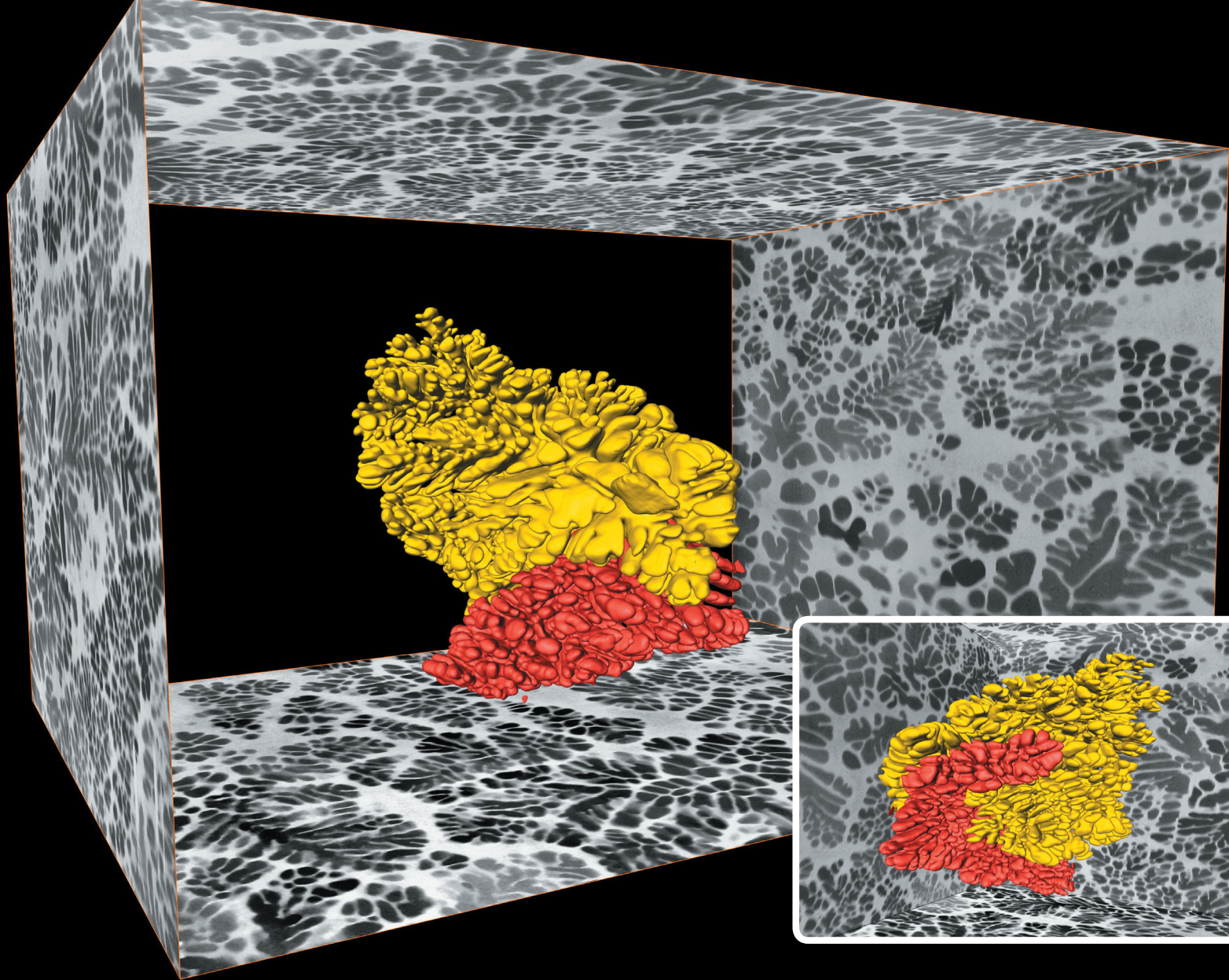

FEI Avizo® 3D visualization of two large adjacent crystalline dendrites of a bulk-metallic-glass matrix composite ( $Zr_{58.5}Ti_{14.3}Nb_{5.2}Cu_{6.1}Ni_{4.9}Be_{10}$ ). Data was obtained by large volume serial sectioning tomography using the Helios PFIB DualBeam. The sectioned block is about  $90 \times 80 \times 70 \mu m^3$ . Sample from The University of Tennessee, USA. Images courtesy of The University of Manchester.

## Large 3D volumes with unprecedented surface resolution

Until recently, available technologies have limited the volumes and depths of materials that can be analyzed at high resolution, ultimately restricting the insight into structural, crystallographic, and chemical properties. This is no longer the case. The Helios™ PFIB DualBeam™ offers unrivaled access to regions of interest deep below the surface—combining serial section tomography with statistically relevant data analysis.

Discover more at [FEI.com/Helios-PFIB](https://FEI.com/Helios-PFIB)



Explore. Discover. Resolve.



# Microscopy AND Microanalysis

An International Journal for the Biological and Physical Sciences

Volume 22, Number 4

August 2016

## TECHNIQUE AND INSTRUMENTATION DEVELOPMENT

Electron-Excited X-Ray Microanalysis at Low Beam Energy: Almost Always an Adventure 735

*Dale E. Newbury and Nicholas W.M. Ritchie*

Spatial Resolution in Scanning Electron Microscopy and Scanning Transmission Electron Microscopy Without a Specimen Vacuum Chamber 754

*Kayla X. Nguyen, Megan E. Holtz, Justin Richmond-Decker, and David A. Muller*

Comparison of Electron Imaging Modes for Dimensional Measurements in the Scanning Electron Microscope 768

*Michael T. Postek, András E. Vladár, John S. Villarrubia, and Atsushi Muto*

Suppressing Electron Exposure Artifacts: An Electron Scanning Paradigm with Bayesian Machine Learning 778

*Karl Hujsak, Benjamin D. Myers, Eric Roth, Yue Li, and Vinayak P. Dravid*

Performance of Dynamically Simulated Reference Patterns for Cross-Correlation Electron Backscatter Diffraction 789

*Brian E. Jackson, Jordan J. Christensen, Saransh Singh, Marc De Graef, David T. Fullwood, Eric R. Homer, and Robert H. Wagoner*

Two-Color, Two-Photon Imaging at Long Excitation Wavelengths Using a Diamond Raman Laser 803

*Johanna Trägårdh, Michelle Murtagh, Gillian Robb, Maddy Parsons, Jipeng Lin, David J. Spence, and Gail McConnell*

## MATERIALS APPLICATIONS

Nanoscale Three-Dimensional Microstructural Characterization of an Sn-Rich Solder Alloy Using High-Resolution Transmission X-Ray Microscopy (TXM) 808

*Chandrashekara S. Kaira, Carl R. Mayer, V. De Andrade, Francesco De Carlo, and Nikhilesh Chawla*

Effect of Gas Pores on Mechanical Properties of High-Pressure Die-Casting AM50 Magnesium Alloy 814

*Wei Jiang, Zhanyi Cao, Liping Liu, and Bo Jiang*

Online Wear Detection Using High-Speed Imaging 820

*Seyfollah Soleimani, Jacob Sukumaran, Koen Douterloigne, Patrick De Baets, and Wilfried Philips*

The Tensile Behavior of High-Strength Carbon Fibers 841

*Tye Langston*

Microchemical Study of Pigments and Binders in Polychrome Relics from Maiji Mountain Grottoes in Northwestern China 845

*Luyao Liu, Wei Shen, Bingjian Zhang, and Qian Ma*

An Examination of the Surface and Sub-Surface of Modern and Historical Platinum Photographic Prints Using Low Vacuum High-Resolution Scanning Electron Microscopy 857

*Patrick Ravines, Natasha Erdman, and Rob McElroy*

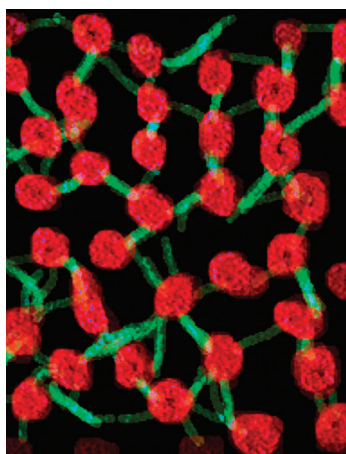

**On the Cover:** Proteoglycan and collagen organization in eye. For further information please see Akhtar et al., pp 922-932.

**Microscopy and Microanalysis website:** <http://www.journals.cambridge.org/MAM>  
Indexed in Chemical Abstracts, Current Contents, BIOSIS, and MEDLINE (PubMed)

## BIOLOGICAL APPLICATIONS

- Intracellular Elemental Patterns of Apoptosis Resistance in Transdifferentiated Androgen-Dependent Prostatic Carcinoma Cells 865  
*Mercedes Salido and Jose Vilches*
- Synthetic Hormones and Clot Formation 878  
*Albe C. Swanepoel, Amcois Visagie, and Ethersia Pretorius*
- Structural and Physicochemical Characterization of Spirulina (*Arthrospira maxima*) Nanoparticles by High-Resolution Electron Microscopic Techniques 887  
*Elier Ekberg Neri-Torres, Jorge J. Chanona-Pérez, Hector A. Calderón, Neil Torres-Figueroa, German Chamorro-Cevallos, Georgina Calderón-Domínguez, and Hugo Velasco-Bedrán*
- Visualizing Quantum Dot Labeled ORAI1 Proteins in Intact Cells Via Correlative Light and Electron Microscopy 902  
*Diana B. Peckys, Dalia Alansary, Barbara A. Niemeyer, and Niels de Jonge*
- Antennal Sensilla and Sexual Dimorphism of the Parasitoid *Trichospilus pupivorus* (Hymenoptera: Eulophidae) 913  
*Isabel Moreira da Silva, Kleber de Sousa Pereira, Thomas Spranghers, José Cola Zanuncio, and José Eduardo Serrão*
- Ultrastructure Features and Three-Dimensional Transmission Electron Tomography of Dhub Lizard (*Uromastyx Aegyptia*) Cornea and Its Adaptation to a Desert Environment 922  
*Saeed Akhtar, Mousa Alkhalaf, Adnan A. Khan, and Turki M. Almubrad*

Hitachi strives to provide comprehensive solutions to support your success, not only from inside the lab, but beyond, by providing high-value, innovative, robust, and ergonomic products. Our latest technology demonstrates our commitment to you and the advancement of microscopy.

## The All New FlexSEM 1000 VP-SEM

**Think Outside the Lab**

Novel, compact VP-SEM delivering the performance of a conventional SEM in a lab-friendly footprint with a user-friendly GUI, and only standard wall outlet power required.

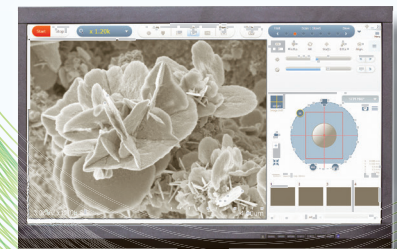

Request a demo or product info: [microscopy@hitachi-hta.com](mailto:microscopy@hitachi-hta.com)

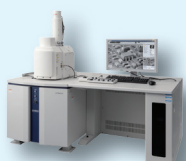

VP-SEM, FE-SEM & FIB



TEM & STEM



Atmospheric SEM



Tabletop SEM



Atomic Force Microscopy



Sample Preparation

# Expand your Knowledge of Microscopy with MSA Membership!

Whether your primary focus is in light, electron, or scanning probe microscopy, or the biological or the physical sciences, MSA takes your knowledge to the next level!

## Members Receive:

- A personal subscription to MSA's official journal, *Microscopy and Microanalysis*, and MSA's popular bi-monthly magazine, *Microscopy Today*.
- Peer Networking through the Society's Focused Interest Groups and Local Affiliated Societies.
- Discounts on books, journals and other educational materials.
- MSA Awards Programs, Scholarships, Speaker Opportunities, and more!



**Join MSA Today!**

Visit: [www.microscopy.org](http://www.microscopy.org) or call 1-800-538-3672

# 13 MEGAPIXEL AUTOFOCUS CAMERA



- Full HD at 30 FPS
- Captures Full Image Circle
- C-Mount Adapter & Eyepiece Included
- No Relay Lens Necessary
- Excellent Color Rendition
- Free Imaging & Measurement Tools

 **THE IMAGINGSOURCE**  
TECHNOLOGY BASED ON STANDARDS

[www.theimagingsource.com](http://www.theimagingsource.com)

# Expand your Knowledge of Microscopy with **MSA Membership!**

**Whether your primary focus is in optical, electron or scanning probe microscopy, the biological or the physical sciences, MSA takes your knowledge to the next level!**

## **Members Receive:**

- A personal subscription to MSA's official journal, *Microscopy and Microanalysis*, and MSA's popular bi-monthly magazine, *Microscopy Today*.
- Peer Networking through the Society's Focused Interest Groups and Local Affiliated Societies.
- Discounts on books, journals and other educational materials.
- MSA Awards Programs, Scholarships, Speaker Opportunities, and much more!

## **Join MSA Today!**



For more information:  
visit [www.microscopy.org](http://www.microscopy.org)  
or call 1-800-538-3672

Someone has to be first.  
XFlash® FlatQUAD, multiple detector systems & VZ

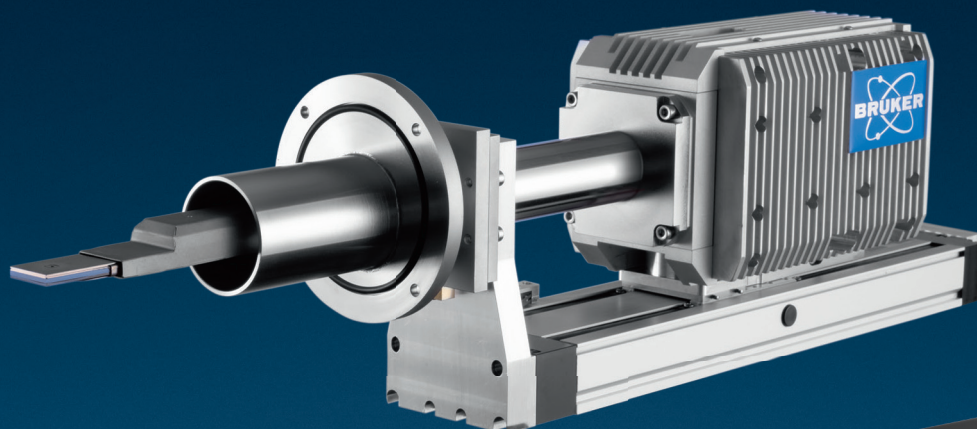

Analyze textured  
samples with ease.



- The unique XFlash® FlatQUAD offers a large solid angle and an amazing take-off angle. This minimizes shadowing so you can see every nook and cranny of your sample in record time.
- Bruker's multiple detector systems provide large solid angles and great take-off angles too. You can start with one detector building up to four, depending on your needs.
- The Variable Z (VZ) adapter allows you to optimize take-off angles in-situ, which significantly improves the analysis of topographically challenging samples.

**Someone has to be first.**



[www.bruker.com/quantax-flatquad](http://www.bruker.com/quantax-flatquad)

Innovation with Integrity

EDS

# NO COMPROMISE

## ATOMIC RESOLUTION + FAST ANALYSIS

The New "Go-To" TEM from JEOL

# F2

- Cold FEG boosts probe current
- Fast 3D EDS with dual SDD
- Wide-field STEM-EELS spectrum imaging
- Push-button beam conditions
- Ultra-stable, ultra-fast



10 nm

2 nm

# JEOL

Solutions for Innovation



2 nm

[www.jeolusa.com](http://www.jeolusa.com)  
[salesinfo@jeol.com](mailto:salesinfo@jeol.com) • 978-535-5900

Learn more at [www.jeolusa.com/F2](http://www.jeolusa.com/F2)

\*STEM-HAADF image of Quasicrystal • Courtesy of Professor Emeritus K. Hiraga - Tohoku University



# ATMOSPHERE

Real World Environment. Real In Situ

Ceria  
350 °C  
1 atm H<sub>2</sub>/N<sub>2</sub>

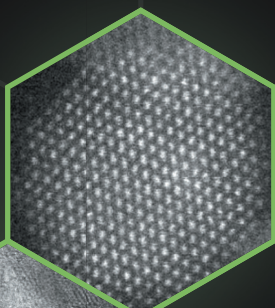

Gold on Ceria  
350 °C  
1 atm H<sub>2</sub>/N<sub>2</sub>

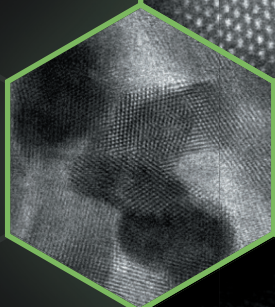

Gold on  
Iron Oxide  
350 °C  
7.5 Torr N<sub>2</sub>

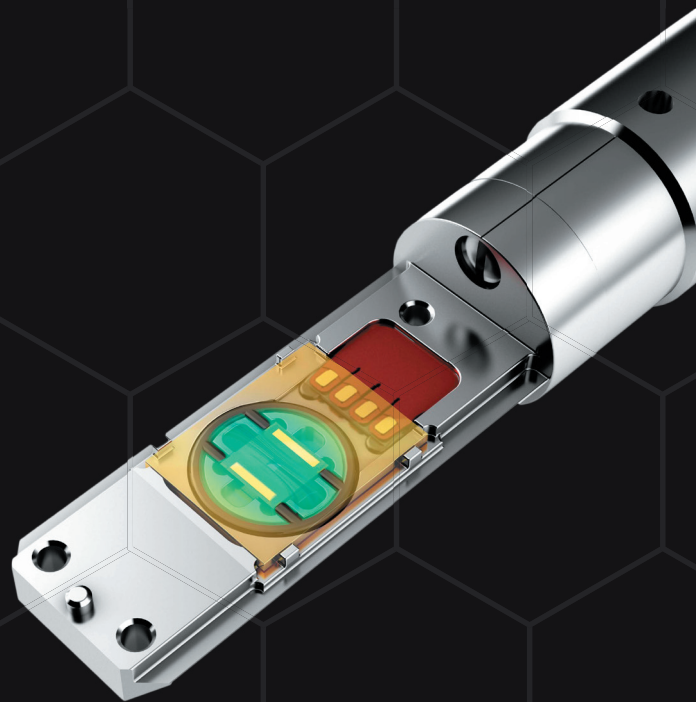
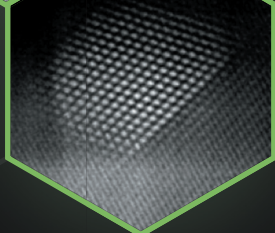

Image Courtesy (top to bottom): University of Michigan, Oak Ridge National Laboratory, JEOL Japan

## Protochips, booth #1408 at M&M

Features Clarity workflow software with ImageSync.  
Pressures up to 1 atm and temperatures up to 1000 °C.  
EDS compatible and safety approved by FEI and JEOL.

To learn more about Atmosphere, sign up for our upcoming Webinar hosted by Materials today. Scan the QR code or visit the link below.

[www.protochips.com/protochips\\_webinar](http://www.protochips.com/protochips_webinar)





## Octane Elite Silicon Drift Detectors Elite Technology for Elite Results

TEAM™  
EDS

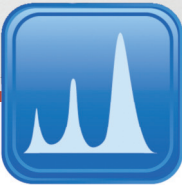

TEAM™  
EBSD



TEAM™  
WDS

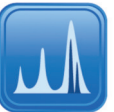

- Light element sensitivity increased up to 60% using new  $\text{Si}_3\text{N}_4$  window
- Highest throughput SDD on the market
- Unparalleled resolution stability
- Highly reliable and moisture tolerant
- Safe for plasma cleaning

**AMETEK®**

MATERIALS ANALYSIS DIVISION

<https://doi.org/10.1017/S1431927616011533> Published online by Cambridge University Press

[edax.com](http://edax.com)

**EDAX®**  
Smart Insight